



Alienware AW3423DWF Monitor User's Guide

Monitor Model: AW3423DWF
Regulatory Model: AW3423DWFb

A L I E N W A R E™ 

Notes, cautions, and warnings

-  **NOTE:** A NOTE indicates important information that helps you make better use of your computer.
-  **CAUTION:** A CAUTION indicates potential damage to hardware or loss of data if instructions are not followed.
-  **WARNING:** A WARNING indicates a potential for property damage, personal injury, or death.

© 2022-2023 Dell Inc. or its subsidiaries. All rights reserved. Dell, EMC, and other trademarks are trademarks of Dell Inc. or its subsidiaries. Other trademarks may be trademarks of their respective owners.

2023 - 01

Rev. A01

Contents

Safety instructions	6
About your monitor	7
Package contents	7
Product features	9
Identifying parts and controls	10
Front view	10
Back view	11
Rear and bottom view	12
Monitor specifications	14
Resolution specifications	15
Supported video modes	16
HDMI preset display modes	16
DisplayPort preset display modes	17
Electrical specifications	18
Physical characteristics	19
Environmental characteristics	20
Pin assignments	21
DisplayPort connector	21
HDMI connector	22
Universal Serial Bus (USB) interface	23
Plug-and-Play capability	25
QD-OLED monitor quality and pixel policy	25
Ergonomics	25
Handling and moving your display	27
Maintenance guidelines	28
Cleaning your monitor	28

Setting up the monitor	30
Attaching the stand	30
Connecting the computer	34
Connecting the DisplayPort (DP to DP) cable	35
Connecting the USB-C-DisplayPort cable	35
Connecting the HDMI cable (optional)	36
Removing the monitor stand	36
VESA wall mounting (optional)	38
Operating the monitor	39
Turn on the monitor	39
Using the joystick	39
Using the On-Screen Display (OSD) menu	40
Accessing the Menu Launcher	40
Accessing the menu system	42
Console mode	64
OSD warning message	65
Locking the control buttons	69
Setting the maximum resolution	70
Requirements to view or playback HDR content	71
Using the tilt, swivel, and vertical extension	72
Tilt and swivel extensions	72
Vertical extension	72
Using AlienFX application	73
Prerequisites	73
Installing AWCC through Windows update	73
Installing AWCC from the Dell Support website	73
Navigating the AlienFX window	74
Creating a theme	77
Setting the lighting effects	78
Settings	81

Customization of AlienVision81
Game configuration 83
Troubleshooting.....83
Troubleshooting84
Self-test84
Common problems85
Product specific problems88
Universal Serial Bus (USB) specific problems..... 91
Regulatory information92
FCC notices (U.S. only) and other regulatory
information.....92
EU product database for energy label and product
information sheet92
Contacting Dell.....92

Safety instructions

Use the following safety guidelines to protect your monitor from potential damage and to ensure your personal safety. Unless otherwise noted, each procedure included in this document assumes that you have read the safety information that shipped with your monitor.

 **NOTE: Before using the monitor, read the safety information that is shipped with your monitor and printed on the product. Keep the documentation at a secure location for future reference.**

 **WARNING: Use of controls, adjustments, or procedures other than those specified in this documentation may result in exposure to shock, electrical hazards, and/or mechanical hazards.** 

WARNING: The possible long-term effect of listening to audio at high volume through the headphones (on monitor that support it) may cause damage to your hearing ability.

- Place the monitor on a solid surface and handle it carefully. The screen is fragile and can be damaged if dropped or hit with a sharp object.
- Ensure that your monitor is electrically rated to operate with the AC power available in your location.
- Keep the monitor in room temperature. Excessive cold or hot conditions can have an adverse effect on the liquid crystals of the display.
- Connect the power cable from the monitor to a wall outlet that is near and accessible. See [Connecting the computer](#).
- Do not place and use the monitor on a wet surface or near water.
- Do not subject the monitor to severe vibration or high impact conditions. For example, do not place the monitor inside a car trunk.
- Unplug the monitor when it is going to be left unused for an extended period.
- To avoid electric shock, do not attempt to remove any cover or touch the inside of the monitor.
- Read these instructions carefully. Keep this document for future reference. Follow all warnings and instructions marked on the product.
- Certain monitors can be wall mounted using the VESA mount that is sold separately. Ensure to use the correct VESA specifications as mentioned in the wall mounting section of the *User's Guide*.





For information on safety instructions, see the *Safety, Environmental, and Regulatory Information* (SERI) document that is shipped with your monitor.



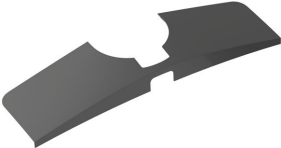

About your monitor

Package contents

The following table provides the list of components that are shipped with your monitor. If any component is missing, contact Dell. For more information, see [Contacting Dell](#).

 **NOTE: Some components may be optional and may not ship with your monitor. Some features may not be available in certain countries.**

Component image	Component description
	Display
	Stand riser
	Stand base
	I/O cover
	Power cable (varies by country)

	<p>DisplayPort to DisplayPort 1.4 cable (1.80 meters)</p>
	<p>USB 3.2 Gen 1 (5 Gbps) upstream cable (enables the USB ports on the monitor, 1.80 meters)</p>
	<p>USB Type-C to DisplayPort 1.4 cable (1 meter)</p>
	<p>Microfiber cloth</p>
	<ul style="list-style-type: none"> ▪ Quick Start Guide ▪ Factory calibration report ▪ Safety, Environmental, and Regulatory Information ▪ Alienware Sticker

Product features

The **Alienware AW3423DWF** is a Quantum Dot–Organic Light Emitting Diode (QD–OLED) display that uses Oxide TFT as active element. The monitor features include:

- 86.82 cm (34.18 in.) viewable area (measured diagonally). Resolution: Up to 3440 x 1440 through DisplayPort and HDMI, with full-screen support or lower resolutions, supporting a high refresh rate of 165 Hz.
- AMD FreeSync Premium Pro Technology and VESA AdaptiveSync Display certification minimize graphic distortions like screen tearing and stuttering for smoother, fluid gameplay.
- Color gamut of 149% sRGB and DCI-P3 99.3%.
- Tilt, swivel, and height adjustment capabilities.
- Removable stand and Video Electronics Standards Association (VESA) 100 mm mounting holes for flexible mounting solutions.
- Digital connectivity through two DisplayPort and one HDMI ports.
- The monitor is equipped with:
 - One SuperSpeed USB 5 Gbps (USB 3.2 Gen 1) Type-B upstream port
 - One SuperSpeed USB 5 Gbps (USB 3.2 Gen 1) Type-A downstream charging port
 - Three SuperSpeed USB 5 Gbps (USB 3.2 Gen 1) Type-A downstream ports
- Plug-and-play capability if supported by your computer.
- On-Screen Display (OSD) adjustments for ease of setup and screen optimization.
- Supports Picture by Picture (PBP), Picture in Picture (PIP) and Console Mode.
- AW3423DWF offers a couple of preset modes for user's own preference, including:
 - Creator
 - First-Person Shooter (FPS)
 - Multiplayer Online Battle Arena/Real-Time Strategy (MOBA/RTS)
 - Role-Playing Game (RPG)
 - Racing (SPORTS)
 - Three customizable game modes

In addition, key enhanced gaming features such as Timer, Frame Rate, and Display Alignment are provided to help improve gamer's performance and provide best-in game advantage.

- Security-lock slot.
- Power consumption ≤ 0.5 W in Standby Mode.
- VESA DisplayHDR 400 True Black.
- Optimize eye comfort with a flicker-free screen and ComfortView Plus feature.
- The Monitor uses Low Blue Light panel and is compliant with TÜV Rheinland (Hardware Solution) at factory reset or default setting. This built-in low blue light solution reduces hazardous blue light emissions by adjusting display parameters, without sacrificing true-to-life colors.

⚠ WARNING: The possible long-term effects of blue light emission from the monitor may cause damage to the eyes, which includes but is not limited to eye fatigue and digital eye strain. ComfortView Plus feature is designed to reduce the amount of blue light emitted from the monitor to optimize eye comfort.

Identifying parts and controls

Front view

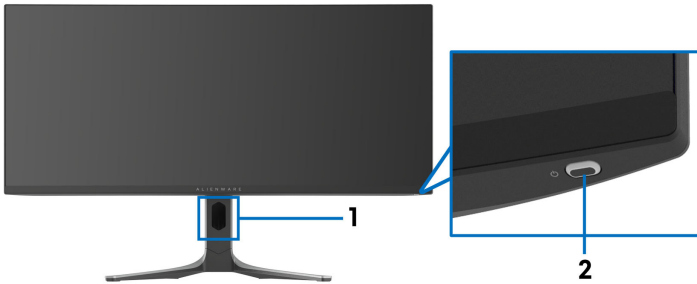

Label	Description	Use
1	Cable-management slot (on the front side of the stand)	To organize the cables neatly.
2	Power button (with LED indicator)	To turn the monitor on or off. Solid blue light indicates that the monitor is turned on and functioning normally. Blinking white light indicates that the monitor is in Standby Mode.

Back view

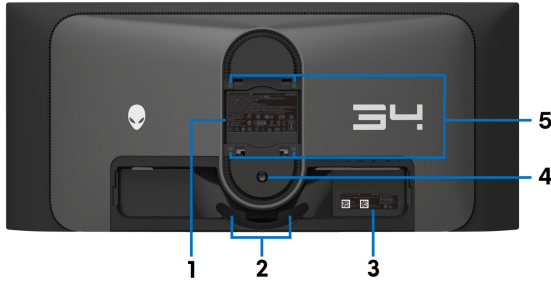

Back view without monitor stand

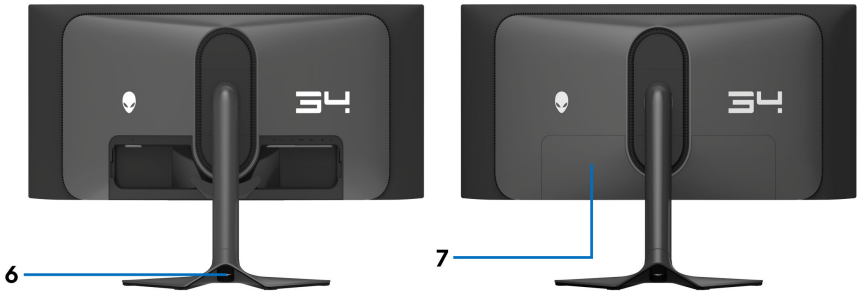

Back view with monitor stand



Label	Description	Use
1	Regulatory label	Lists the regulatory approvals.
2	Cable-management clips (2)	To organize the cables neatly.
3	Barcode, serial number, and Service Tag label	See this label if you need to contact Dell for technical support. The Service Tag is a unique alphanumeric identifier that enables Dell service technicians to identify the hardware components in your monitor and access warranty information.
4	Stand release button	Releases the stand from the monitor.
5	VESA mounting holes (100 mm x 100 mm - behind VESA Cover)	Wall mount monitor using VESA-compatible wall mount kit (100 mm x 100 mm).



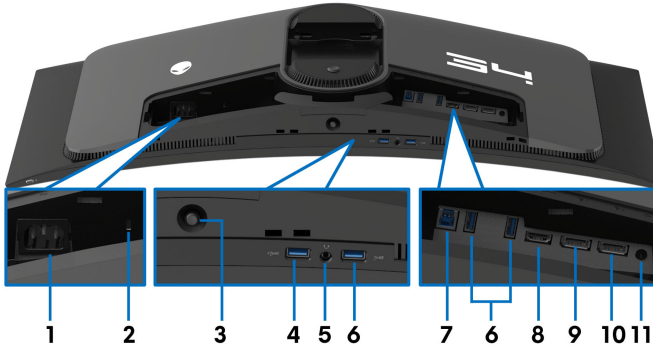

6	Cable-management slot (at the back of the stand)	To organize cables by routing them through this slot.
7	I/O cover	Protects the I/O ports.

Rear and bottom view



Rear and bottom view without monitor stand

Label	Description	Use
1	Power connector	Connect the power cable (shipped with your monitor).
2	Security-lock slot (based on Kensington Security Slot)	Secure the monitor with a security lock (security lock not included).
3	Joystick	Use it to control the OSD menu. For more information, see Operating the monitor .
4	SuperSpeed USB 5 Gbps (USB 3.2 Gen 1) Type-A downstream port with Power Charging	<p>Connect to charge your USB device.</p> <p> NOTE: To use this port, you must connect the USB cable (shipped with your monitor) to the USB-upstream port on the monitor and to your computer.</p> <p> NOTE: To avoid signal interference, when a wireless USB device is connected to a USB downstream port, it is not recommended to connect any other USB devices to the adjacent port.</p>

Label	Description	Use
5	Headphone port	Connect the headphone or speakers.  WARNING: The possible long-term effect of listening to audio at high volume through the headphones may cause damage to your hearing ability.
6	SuperSpeed USB 5 Gbps (USB 3.2 Gen 1) Type-A downstream port (3)	Connect your USB 3.2 Gen 1 (5 Gbps) device.  NOTE: To use these ports, you must connect the USB cable (shipped with your monitor) to the USB-upstream port on the monitor and to your computer.  NOTE: To avoid signal interference, when a wireless USB device is connected to a USB downstream port, it is not recommended to connect any other USB devices to the adjacent port.
7	SuperSpeed USB 5 Gbps (USB 3.2 Gen 1) Type-B upstream port	Connect the USB cable (shipped with your monitor) to this port and your computer to enable the USB ports on your monitor.
8	HDMI port	Connect your computer with the HDMI cable (sold separately).
9	DisplayPort (DP1)	Connect your computer with one of the following cables shipped with your monitor: <ul style="list-style-type: none"> ▪ DisplayPort-DisplayPort cable ▪ USB-C-DisplayPort cable
10	DisplayPort (DP2)	
11	Line-out port	Connect your speakers.  NOTE: This port does not support headphones.

Monitor specifications

Description	Value
Screen type	Color Active Matrix
Panel technology	QD OLED
Aspect ratio	21:9
Viewable image	
Diagonal:	868.21 mm (34.18 in.)
Width (active area)	800.10 mm (31.50 in.)
Height (active area)	337.10 mm (13.27 in.)
Total area	269,713.71 mm ² (418.01 in. ²)
Pixel pitch	0.23 mm x 0.23 mm
Pixel per inch (PPI)	110
Viewing angle:	
Vertical	178° (typical)
Horizontal	178° (typical)
Luminance output	250 cd/m ² (typical) 1000 cd/m ² (HDR peak)
Contrast ratio	1 million: 1 at (SDR) and (HDR)
Faceplate coating	Anti reflection
Backlight	OLED
Response time	0.1 ms gray-to-gray
Curvature	1800R (typical)
Color depth	1.07 billion colors (10 bit)
Color gamut	149% sRGB and DCI-P3 99.3%
Integrated devices	<ul style="list-style-type: none">• SuperSpeed USB 5 Gbps (USB 3.2 Gen 1) hub (with one USB 3.2 Gen 1 (5 Gbps) upstream port)• 4 x SuperSpeed USB 5 Gbps (USB 3.2 Gen 1) downstream port (including one port which supports power-charging)

Description	Value
Connectivity	<ul style="list-style-type: none"> ▪ 2 x DisplayPort version 1.4 with HDCP 2.2 (rear) ▪ 1 x HDMI port version 2.0 with HDCP 2.2 (rear) ▪ 1 x USB 3.2 Gen 1 (5 Gbps) upstream port (rear) ▪ 4 x USB 3.2 Gen 1 (5 Gbps) downstream port (bottom: 2; rear: 2) ▪ 1 x headphone port (bottom) ▪ 1 x audio line-out port (rear)
Border width (edge of monitor to active area)	
Top	6.45 mm
Left/Right	10.99 mm/10.99 mm
Bottom	20.60 mm
Adjustability	
Height adjustable stand	0 mm to 110 mm
Tilt	-5° to 21°
Swivel	-20° to 20°
Slant adjust	-5° to 5°
 NOTE: Do not mount or use this monitor in portrait (vertical) orientation or inverse (180°) landscape mount as it may damage the monitor.	
Security	Security-lock slot (cable lock sold separately)
Dell Display Manager compatibility	Easy Arrange and other key features
Alienware Command Center (AWCC)	Yes

Resolution specifications

Description	Value
Horizontal scan range	<ul style="list-style-type: none"> ▪ DisplayPort 1.4: 27 kHz to 285 kHz (automatic) ▪ HDMI 2.0: 27 kHz to 151 kHz (automatic)
Vertical scan range	<ul style="list-style-type: none"> ▪ DisplayPort 1.4: 48 Hz to 165 Hz (automatic) ▪ HDMI 2.0: 48 Hz to 120 Hz (automatic)
Maximum preset resolution	<ul style="list-style-type: none"> ▪ DisplayPort: 3440 x 1440 at 165 Hz ▪ HDMI: 3440 x 1440 at 100 Hz

Supported video modes

Description	Value
Video display capabilities (DisplayPort)	480p, 576p, 720p, 1080p, QHD
Video display capabilities (HDMI)	480p, 576p, 720p, 1080i, 1080p, QHD

HDMI preset display modes

Display mode	Horizontal frequency (kHz)	Vertical frequency (Hz)	Pixel clock (MHz)	Sync polarity (Horizontal/Vertical)
VESA, 640 x 480	31.47	59.94	25.18	-/-
VESA, 640 x 480	37.50	75	31.50	-/-
720 x 400	31.47	70.08	28.32	-/+
VESA, 800 x 600	37.88	60.32	40	+/+
VESA, 800 x 600	46.88	75	49.50	+/+
VESA, 1024 x 768	48.36	60	65	-/-
VESA, 1024 x 768	60.02	75.03	78.75	+/+
VESA, 1152 x 864	67.50	75	108	+/+
VESA, 1280 x 1024	63.98	60.02	108	+/+
VESA, 1280 x 1024	79.98	75.03	135	+/+
VESA, 1600 x 900	60	60	108	+/+
VESA, 1920 x 1080	67.50	60	148.50	+/+
1920 x 1080	135	120	297	+/+
2560 x 1440	183	120	497.75	+/-
3440 x 1440	88.82	59.97	319.75	+/-
3440 x 1440	150.97	99.98	538.37	+/-

DisplayPort preset display modes

Display mode	Horizontal frequency (kHz)	Vertical frequency (Hz)	Pixel clock (MHz)	Sync polarity (Horizontal/Vertical)
VESA, 640 x 480	31.47	59.94	25.18	-/-
VESA, 640 x 480	37.50	75	31.50	-/-
720 x 400	31.47	70.08	28.32	-/+
VESA, 800 x 600	37.88	60.32	40	+/+
VESA, 800 x 600	46.88	75	49.50	+/+
VESA, 1024 x 768	48.36	60	65	-/-
VESA, 1024 x 768	60.02	75.03	78.75	+/+
VESA, 1152 x 864	67.50	75	108	+/+
VESA, 1280 x 1024	63.98	60.02	108	+/+
VESA, 1280 x 1024	79.98	75.03	135	+/+
VESA, 1600 x 900	60	60	108	+/+
VESA, 1920 x 1080	67.50	60	148.50	+/+
1920 x 1080	135	120	297	+/+
1920 x 1080	162.25	143.84	337.49	+/-
2560 x 1440	88.79	59.95	241.50	+/-
2560 x 1440	183	120	497.75	+/-
2560 x 1440	222.15	143.97	604.25	+/-
3440 x 1440	88.82	59.97	319.75	+/-
3440 x 1440	150.97	99.98	538.37	+/-
3440 x 1440	283.13	164.90	1019.27	+/-

 **NOTE: This monitor supports AMD FreeSync Premium Pro Technology.**

Electrical specifications

Description	Value
Video input signals	HDMI 2.0/DisplayPort 1.4, 600 mV for each differential line, 100 Ω input impedance per differential pair
AC input voltage/frequency/current	100 VAC to 240 VAC/50 Hz or 60 Hz \pm 3 Hz/3 A (typical)
Inrush current	<ul style="list-style-type: none">▪ 120 V: 40 A (maximum) at 0°C (cold start)▪ 240 V: 80 A (maximum) at 0°C (cold start)
Power consumption	<ul style="list-style-type: none">▪ 0.3 W (Off mode)¹▪ 0.5 W (Standby mode)¹▪ 34.0 W (On mode)¹▪ 200 W (Max.)²▪ 39.2 W (P_{on})³▪ 123.0 kWh (TEC)³

¹ As defined in EU 2019/2021 and EU 2019/2013.

² Maximum brightness and contrast setting with maximum power loading on all USB ports.

³ P_{on} : Power consumption of On Mode measured with reference to Energy Star test method.

TEC: Total Energy Consumption in kWh measured with reference to Energy Star test method.

This document is informational only and reflects laboratory performance. Your product may perform differently, depending on the software, components and peripherals you ordered and shall have no obligation to update such information.

Accordingly, the customer should not rely upon this information in making decisions about electrical tolerances or otherwise. No warranty as to accuracy or completeness is expressed or implied.

Physical characteristics

Description	Value
Signal cable type	<ul style="list-style-type: none"> ▪ Digital: HDMI, 19 pins (cable not included) ▪ Digital: DisplayPort, 20 pins ▪ Digital: USB-C (24 pins) to DisplayPort (20 pins) ▪ Universal Serial Bus: USB, 9 pins
<p> NOTE: Dell monitors are designed to work optimally with the video cables that are shipped with your monitor. As Dell does not have control over different cable suppliers in the market, the type of material, connector, and process used to manufacture these cables, Dell does not guarantee video performance of cables that are not shipped with your Dell monitor.</p>	
Dimensions (with stand):	
Height (extended)	525.57 mm (20.69 in.)
Height (compressed)	415.57 mm (16.36 in.)
Width	815.25 mm (32.10 in.)
Depth	305.71 mm (12.04 in.)
Dimensions (without stand):	
Height	364.15 mm (14.34 in.)
Width	815.25 mm (32.10 in.)
Depth	127.11 mm (5 in.)
Stand dimensions:	
Height (extended)	411.81 mm (16.21 in.)
Height (compressed)	382.13 mm (15.04 in.)
Width	430.72 mm (16.96 in.)
Depth	305.71 mm (12.04 in.)
Weight:	
Weight with packaging	14.57 kg (32.12 lb)
Weight with stand assembly and cables	9.65 kg (21.27 lb)

Description	Value
Weight without stand assembly (For wall mount or VESA mount considerations - no cables)	6.27 kg (13.82 lb)
Weight of stand assembly	3.02 kg (6.66 lb)

Environmental characteristics

Description	Value
Compliant standards	
<ul style="list-style-type: none"> ▪ RoHS-compliant ▪ Arsenic-free glass and mercury-free for the panel only 	
Temperature:	
Operating	0°C to 40°C (32°F to 104°F)
Non-operating	<ul style="list-style-type: none"> ▪ Storage: -20°C to 60°C (-4°F to 140°F) ▪ Shipping: -20°C to 60°C (-4°F to 140°F)
Humidity:	
Operating	10% to 80% (non-condensing)
Non-operating	<ul style="list-style-type: none"> ▪ Storage: 10% to 90% (non-condensing) ▪ Shipping: 10% to 90% (non-condensing)
Altitude:	
Operating	5,000 m (16,404 ft) (maximum)
Non-operating	12,192 m (40,000 ft) (maximum)
Thermal dissipation	<ul style="list-style-type: none"> ▪ 684 BTU/hour (maximum) ▪ 116.28 BTU/hour (typical)

Pin assignments

DisplayPort connector

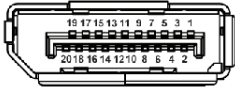

Pin number	20-pin side of the connected signal cable
1	ML3 (n)
2	GND
3	ML3 (p)
4	ML2 (n)
5	GND
6	ML2 (p)
7	ML1 (n)
8	GND
9	ML1 (p)
10	ML0 (n)
11	GND
12	ML0 (p)
13	GND
14	GND
15	AUX (p)
16	GND
17	AUX (n)
18	Hot Plug Detect
19	Re-PWR
20	+3.3 V DP_PWR

HDMI connector

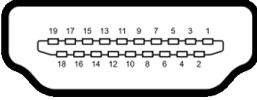

Pin number	19-pin side of the connected signal cable
1	TMDS DATA 2+
2	TMDS DATA 2 SHIELD
3	TMDS DATA 2-
4	TMDS DATA 1+
5	TMDS DATA 1 SHIELD
6	TMDS DATA 1-
7	TMDS DATA 0+
8	TMDS DATA 0 SHIELD
9	TMDS DATA 0-
10	TMDS CLOCK+
11	TMDS CLOCK SHIELD
12	TMDS CLOCK-
13	CEC
14	Reserved (N.C. on device)
15	DDC CLOCK (SCL)
16	DDC DATA (SDA)
17	DDC/CEC Ground
18	+5 V POWER
19	HOT PLUG DETECT

Universal Serial Bus (USB) interface

This section provides information about the USB ports that are available on the monitor.

NOTE: This monitor is SuperSpeed USB 5 Gbps (USB 3.2 Gen 1) compatible.

Transfer speed	Data rate	Power consumption*
Super-Speed	5 Gbps	4.50 W (maximum each port)
High speed	480 Mbps	4.50 W (maximum each port)
Full speed	12 Mbps	4.50 W (maximum each port)

*Up to 2 A on USB downstream port (with  battery icon) with battery charging version-compliant devices or normal USB devices.

USB 3.2 Gen 1 (5 Gbps) upstream connector

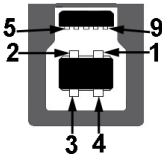

Pin number	9-pin side of the connector
1	VCC
2	D-
3	D+
4	GND
5	SSTX-
6	SSTX+
7	GND
8	SSRX-
9	SSRX+

USB 3.2 Gen 1 (5 Gbps) downstream connector





Pin number	9-pin side of the connector
1	VCC
2	D-
3	D+
4	GND
5	SSRX-
6	SSRX+
7	GND
8	SSTX-
9	SSTX+

USB ports

Port	Location
1 x upstream	rear
2 x downstream	rear
2 x downstream	bottom

Power charging port - the port with  icon; supports up to 2 A fast-charging capability if the device is BC1.2 compatible.

-  **NOTE: SuperSpeed USB 5 Gbps (USB 3.2 Gen 1) functionality requires a SuperSpeed USB 5 Gbps (USB 3.2 Gen 1)-capable computer.**
-  **NOTE: The USB ports on the monitor work only when the monitor is turned on or in Standby mode. If you turn off the monitor and then turn it on, the attached devices may take a few seconds to resume normal functionality.**

Plug-and-Play capability

You can connect the monitor to any Plug-and-Play compatible computer. The monitor automatically provides the computer with its Extended Display Identification Data (EDID) using Display Data Channel (DDC) protocols so that the computer can configure itself and optimize the monitor settings. Most monitor installations are automatic; you can select different settings, if required. For more information about changing the monitor settings, see [Operating the monitor](#).

QD-OLED monitor quality and pixel policy

During the QD-OLED monitor manufacturing process, it is not uncommon for one or more pixels to become fixed in an unchanging state, which are hard to see and do not affect the display quality or usability. For more information about Dell Monitor Quality and Pixel Policy, see www.dell.com/pixelguidelines.

Ergonomics

△ CAUTION: Improper or prolonged usage of keyboard may result in injury.

△ CAUTION: Viewing the monitor screen for extended periods of time may result in eye strain.

For comfort and efficiency, observe the following guidelines when setting up and using your computer workstation:

- Position your computer so that the monitor and keyboard are directly in front of you as you work. Special shelves are commercially available to help you correctly position your keyboard.
- To reduce the risk of eye strain and neck, arm, back, or shoulder pain from using the monitor for long period, we recommend you to:
 1. Set the distance of the screen between 20 to 28 in. (50 - 70 cm) from your eyes.
 2. Blink frequently to moisten your eyes or wet your eyes with water after prolonged usage of the monitor.
 3. Take regular and frequent breaks for 20 minutes every two hours.
 4. Look away from your monitor and gaze at a distant object that is 20 feet away for at least 20 seconds during the breaks.
 5. Perform stretches to relieve tension in the neck, arm, back, and shoulders during the breaks.
- Ensure that the monitor screen is at eye level or slightly lower when you are sitting in front of the monitor.

- Adjust the tilt of the monitor, its contrast, and brightness settings.
- Adjust the ambient lighting around you (such as overhead lights, desk lamps, and the curtains or blinds on nearby windows) to minimize reflections and glare on the monitor screen.
- Use a chair that provides good lower-back support.
- Keep your forearms horizontal with your wrists in a neutral, comfortable position while using the keyboard or mouse.
- Always leave space to rest your hands while using the keyboard or mouse.
- Let your upper arms rest naturally on both sides.
- Ensure that your feet are resting flat on the floor.
- When sitting, make sure that the weight of your legs is on your feet and not on the front portion of your seat. Adjust your chair's height or use a footrest if necessary, to maintain a proper posture.
- Vary your work activities. Try to organize your work so that you do not have to sit and work for extended periods of time. Try to stand or get up and walk around at regular intervals.
- Keep the area under your desk clear of obstructions and cables or power cords that may interfere with comfortable seating or present a potential trip hazard.

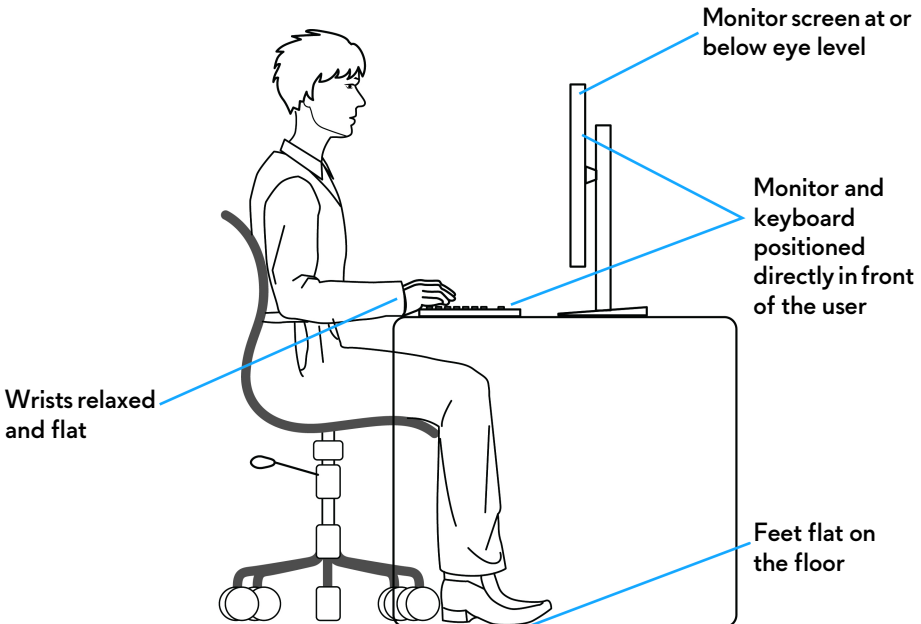

Handling and moving your display

To ensure that the monitor is handled safely when lifting or moving it, follow these guidelines:

- Before moving or lifting the monitor, turn off your computer and the monitor.
- Disconnect all cables from the monitor.
- Place the monitor in the original box with the original packing materials.
- Hold the bottom edge and the side of the monitor firmly without applying excessive pressure when lifting or moving the monitor.

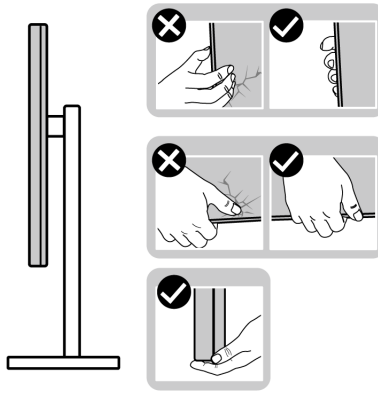

- When lifting or moving the monitor, ensure the screen is facing away from you and do not press on the display area to avoid any scratches or damage.

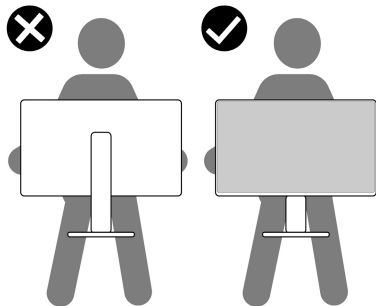

- When transporting the monitor, avoid any sudden shock or vibration to it.

- When lifting or moving the monitor, do not turn the monitor upside down while holding the stand base or stand riser. This may result in accidental damage to the monitor or cause personal injury.

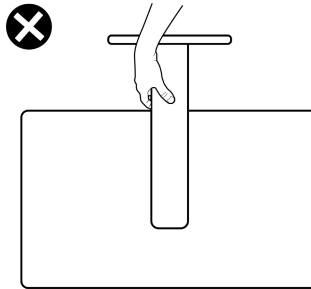

Maintenance guidelines

Cleaning your monitor

- ⚠ **WARNING:** Using improper methods when cleaning the monitor can result in a physical damage to the screen or the body of your Dell monitor.
- ⚠ **CAUTION:** Read and follow the [Safety instructions](#) before cleaning the monitor.
- ⚠ **WARNING:** Before cleaning the monitor, unplug the monitor power cable from the electrical outlet.

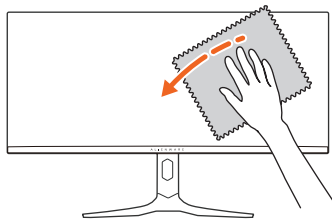

For best practices, follow the instructions in the list below when unpacking, cleaning, or handling your monitor:

- To clean the Dell monitor screen, lightly dampen a soft, clean cloth with water. If possible, use a special screen-cleaning tissue or solution suitable for the Dell monitor screen.
- Using available dry cloth, gently wipe the film surface in one direction at a time to remove stain and dust.



- ⚠ **CAUTION:** Do not use detergents or other chemicals such as benzene, thinner, ammonia, abrasive cleaners, or compressed air.

△ CAUTION: Using chemicals for cleaning may cause changes in the appearance of the monitor, such as color fading, milky film on the monitor, deformation, uneven dark shade, and peeling of screen area.

Cleaner	
Do use 	<ul style="list-style-type: none"> ▪ Filtered or distilled water ▪ Neutral or alkali detergent (for example, dish soap) with water ▪ LCD/LED screen cleaner (without Acetone)
Don't use 	<ul style="list-style-type: none"> ▪ Toluene/Acetone/Solvent ▪ Common glass cleaner ▪ Household cleaning products ▪ Abrasive cleaning solution ▪ Cleaner containing hydrogen peroxide

△ WARNING: Do not spray the cleaning solution or even water directly on the monitor surface. Doing so will allow liquids to accumulate at the bottom of the display panel and corrode the electronics resulting in permanent damage. Instead, apply the cleaning solution or water to a soft cloth and then clean the monitor.

✎ NOTE: Monitor damage due to improper cleaning methods and the use of benzene, thinner, ammonia, abrasive cleaners, alcohol, compressed air, detergent of any kind will lead to a Customer Induced Damage (CID). CID is not covered under the standard Dell warranty.

- If you notice white powder when you unpack your monitor, wipe it off with a cloth.
- Handle your monitor with care as a darker-colored monitor may get scratched and show white scuff marks more than a lighter-colored monitor.
- To help maintain the best image quality on your monitor, use a dynamically changing screen saver and turn off your monitor when not in use.

Setting up the monitor

Attaching the stand

- ✎ **NOTE:** The stand is not installed at the factory when shipped.
- ✎ **NOTE:** The following instructions are applicable only for the stand that was shipped with your monitor. If you are attaching a stand that you purchased from any other source, follow the setup instructions that are included with the stand.

⚠ **CAUTION:** The following steps are important to protect your curved screen. Follow the instructions to complete the installation.

1. Remove the stand riser, stand base, and I/O cover from the packaging cushion.

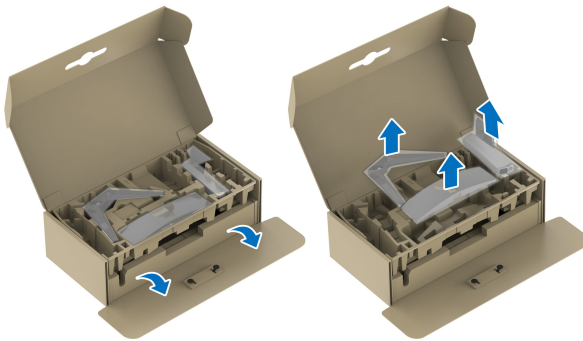

✎ **NOTE:** The images are for the purpose of illustration only. The appearance of the package cushion may vary.

2. Align and place the stand riser on the stand base.
3. Open the screw handle at the bottom of the stand base and turn it clockwise to secure the stand assembly.
4. Close the screw handle.



5. Open the protective cover on the monitor to access the VESA slot on the display back-cover.



6. Carefully insert the tabs on the stand riser into the slots on the display back-cover and lower the stand assembly to snap it into place.



7. Hold the stand riser and lift the monitor carefully, then place it on a flat surface.



△ **CAUTION: Hold the stand riser firmly when lifting the monitor to avoid any accidental damage.**

8. Lift the protective cover from the monitor.

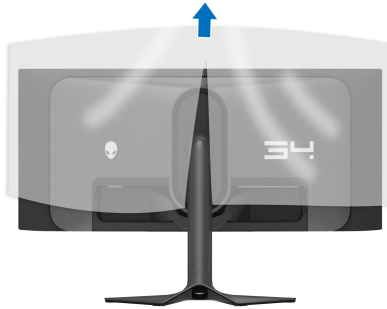

9. Connect the power cable to the monitor.

10. Route the power cable through the cable-management slot on the stand and through the cable-management clips behind the display.

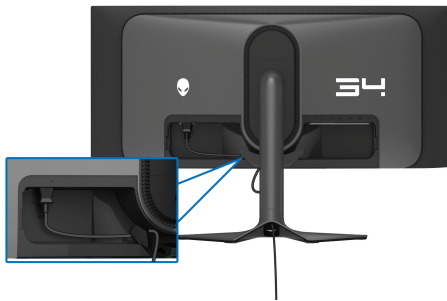

11. Connect the required cables to the monitor, such as DisplayPort-Displayport cable, USB-C-DisplayPort cable, HDMI cable, USB 3.2 Gen 1 (5 Gbps) upstream and downstream cables, and so on.

 **NOTE: The HDMI cable and the USB 3.2 Gen 1 (5 Gbps) downstream cables are not shipped with your display and sold separately.**

 **NOTE: Dell monitors are designed to work optimally with the Dell-supplied cables inside the box. Dell does not guarantee the video quality and performance if non-Dell cables are used.**

12. Route the required cables through the cable-management slot on the stand.



- ✎ **NOTE:** Route each cable neatly so that the cables are organized before the I/O cover is attached.
- ⚠ **CAUTION:** Do not plug the power cable into the wall outlet or turn on the monitor until you are instructed to do so.
- ✎ **NOTE:** If you want to secure your monitor to a table using the Kensington lock, connect the Kensington lock cable to the **Security-lock slot** at this step. For more information about using the Kensington lock (sold separately), see the documentation that is shipped with the lock. The following image is for the purpose of illustration only. The appearance of the lock may vary.

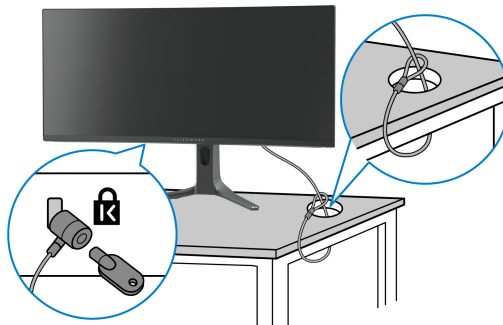

- Slide the tabs on the I/O cover into the slots on the display back cover until it snaps into place.

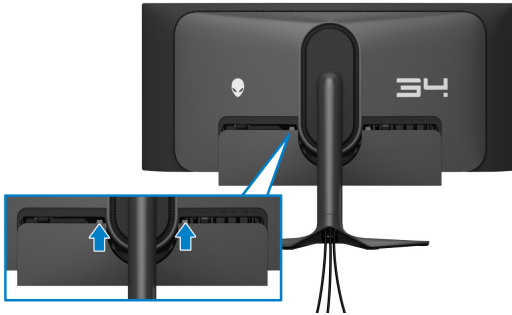

- NOTE:** Ensure that all cables pass through the I/O cover and cable-management slot on the stand riser.

Connecting the computer

- WARNING:** Before you begin any of the procedures in this section, follow the [Safety instructions](#).

- NOTE:** Do not connect all the cables to the computer at the same time.

- NOTE:** The images are for the purpose of illustration only. The appearance of the computer may vary.

To connect your monitor to the computer:

- Connect the other end of the DisplayPort-DisplayPort/USB-C-DisplayPort/HDMI cable to your computer.
 - Connect the other end of the USB 3.2 Gen 1 upstream cable to an appropriate USB 3.2 Gen 1 port on your computer.
 - Connect the USB peripherals to the SuperSpeed USB 5 Gbps (USB 3.2 Gen 1) downstream ports at the bottom of the monitor.
 - Plug the power cables of your computer and monitor into a wall outlet.
- CAUTION:** Before using the monitor, it is recommended to fasten the stand riser to a wall using cable tie or a cord that can support the weight of the monitor in order to prevent the monitor from falling.

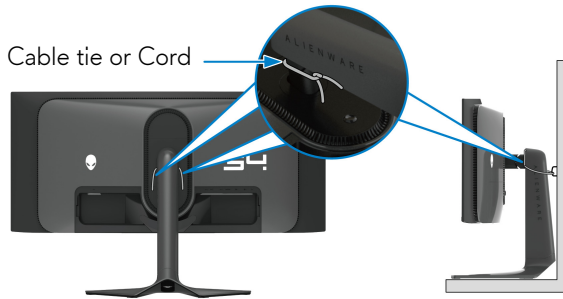

5. Turn on the monitor and the computer.

If your monitor displays an image, installation is complete. If it does not display an image, see [Common problems](#).

Connecting the DisplayPort (DP to DP) cable



Connecting the USB-C-DisplayPort cable

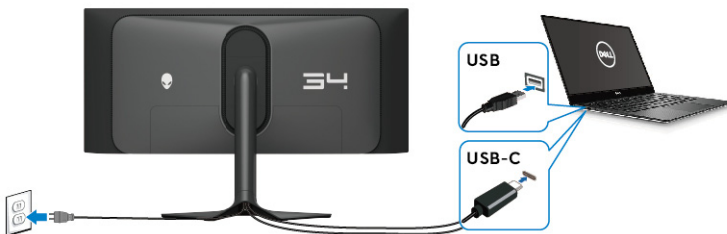

Connecting the HDMI cable (optional)



Removing the monitor stand

- NOTE:** To prevent scratches on the screen when removing the stand, ensure that the monitor is placed on a soft surface and handle it carefully.
- NOTE:** The following steps are specifically for removing the stand that is shipped with your monitor. If you are removing a stand that you purchased from any other source, follow the setup instructions that are included with the stand.

To remove the stand:

1. Turn off the monitor.
2. Disconnect all the cables from the computer.
3. Place the monitor on a soft cloth or cushion.
4. Carefully slide and remove the I/O cover from the monitor.



5. Disconnect the cables from the monitor and slide them out through the cable-management slot on the stand riser.

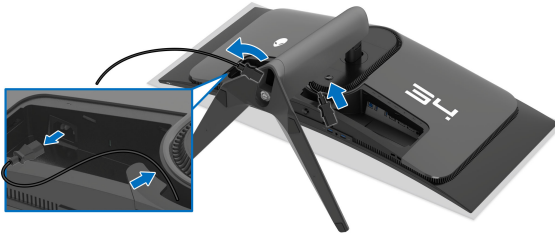

6. Press and hold the stand release button at the back of the display.

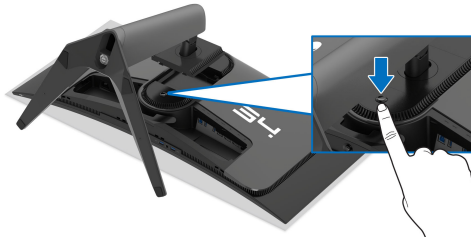

7. Lift the stand assembly up and away from the monitor.



VESA wall mounting (optional)

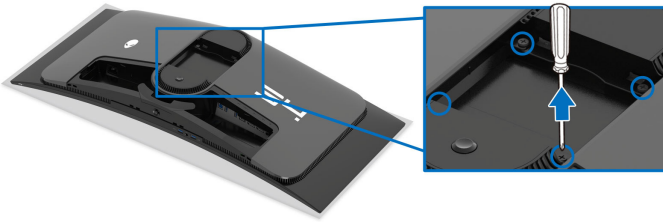

(Screw dimension: M4 x 10 mm)

Refer to the instructions that come with the VESA-compatible wall mounting kit.

1. Place the monitor panel on a soft cloth or cushion on a stable flat surface.
2. Remove the monitor stand. (See [Removing the monitor stand.](#))
3. Use a Phillips crosshead screwdriver to remove the four screws securing the plastic cover.
4. Attach the mounting bracket from the wall mounting kit to the monitor.
5. Mount the monitor on the wall. For more information, see the documentation that shipped with the wall mounting kit.

 **NOTE: For use only with UL-listed wall mount bracket with minimum weight or load bearing capacity of 25.08 kg.**

Operating the monitor

Turn on the monitor

Press the power button to turn on the monitor.



Using the joystick

Use the joystick at the bottom of the monitor to make On-Screen Display (OSD) adjustments.

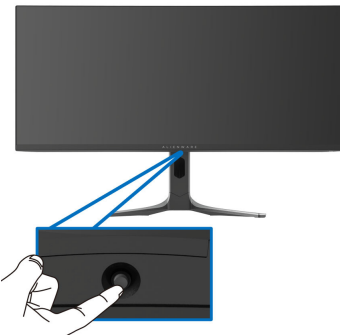





1. Press the joystick to launch the Menu Launcher.
2. Move the joystick forward/backward/left/right to toggle through options.
3. Press the joystick again to confirm the settings and exit.

Joystick

Description



- When the OSD menu is on, press the joystick to confirm the selection or save the settings.
 - When the OSD menu is off, press the joystick to launch the Menu Launcher. See [Accessing the Menu Launcher](#).
-

Joystick	Description
	<ul style="list-style-type: none"> For 4-way (left, right, forward, and backward) directional navigation. Toggles through the menu items. Increases or decreases the parameters of selected menu item.
	Selects and enters the submenu.
	Returns to the upper-level menu or exits the current menu.
	By default, when the OSD menu is off, moving the joystick towards you will toggle through the preset options of AlienVision Toggle List and Off .

Using the On-Screen Display (OSD) menu

Accessing the Menu Launcher





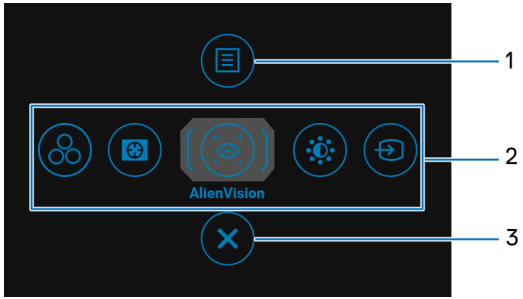

When you move or press the joystick, the Menu Launcher appears at the bottom center of the screen, allowing you to access the OSD menu and shortcut functions.

To select a function, move the joystick.



The following table describes the Menu Launcher functions:

Label	Icon	Description
1	 Menu	To launch the OSD main menu, see Accessing the menu system .

Label	Icon	Description
2	    	<p>When you move the joystick to the left or right to toggle through the shortcut functions, the selected item will be highlighted and shifted to the center position. Press the joystick to enter its submenu. After you change the settings by moving the joystick, press the joystick to save the changes before exiting.</p> <ul style="list-style-type: none"> ▪ Preset Modes: To choose a preferred color mode from the list of preset modes. ▪ Dark Stabilizer: To access the Dark Stabilizer adjustment slider. ▪ AlienVision: To choose a preferred display mode for gameplay or turn off AlienVision. ▪ Brightness/Contrast: To access the adjustment sliders of brightness and contrast. ▪ Input Source: To choose an input source from the list of video signals that may be connected to the monitor.
	<p>Shortcut functions</p>	
	<p> NOTE: You can set your preferred shortcut keys. For more information, see Personalize.</p>	
3		To exit the Menu Launcher.
	<p>Exit</p>	

When you move or press the joystick, the OSD Status Bar appears at the top center of the screen, displaying the current settings of some OSD functions.

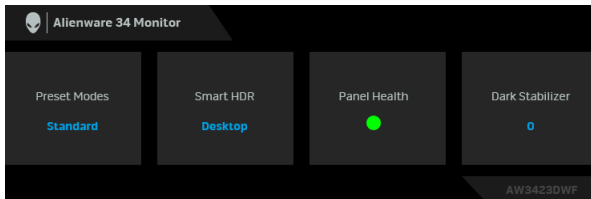

Normally, **Panel Health** displays a green dot. When a yellow dot is displayed, **Pixel Refresh** is suggested to be performed; when a red dot is displayed, it indicates that the monitor has been used for 20 hours without performing **Pixel Refresh** or 1500 hours without performing **Panel Refresh**. For more information, see [OLED Panel Maintenance](#).

Accessing the menu system

After you change the settings, press the joystick to save the changes before proceeding to another menu or exit the OSD menu.

 **NOTE:** To exit the current menu item and return to the previous menu, move the joystick to the left.

Icon	Menu and submenu	Description
	Game	Use this menu to personalize your visual gameplay experience.

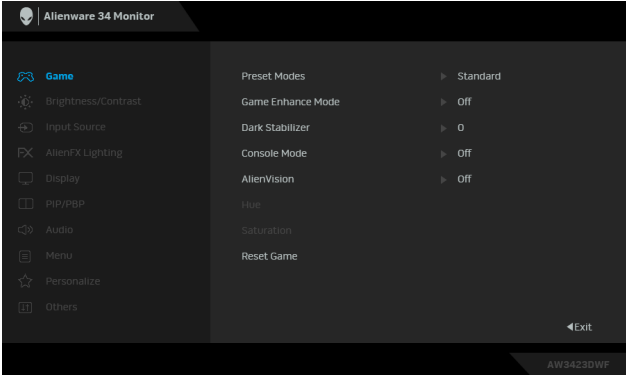

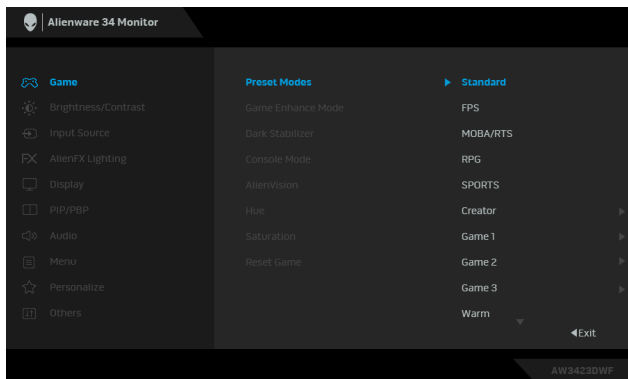

The screenshot shows the Alienware 34 Monitor OSD menu. The 'Game' submenu is selected, showing options: Preset Modes (Standard), Game Enhance Mode (Off), Dark Stabilizer (0), Console Mode (Off), AlienVision (Off), Hue, Saturation, and Reset Game. An 'Exit' button is visible at the bottom right.

Preset Modes Allows you to choose a preset color mode or create your own color modes.



- **Standard:** Loads the monitor's default color settings. This is the default preset mode.

Icon	Menu and submenu	Description
	Preset Modes	<ul style="list-style-type: none"> ▪ FPS: Loads color settings ideal for First-Person Shooter (FPS) games. ▪ MOBA/RTS: Loads color settings ideal for Multiplayer Online Battle Arena (MOBA) and Real-Time Strategy (RTS) games. ▪ RPG: Loads color settings ideal for Role-Playing Games (RPG). ▪ SPORTS: Loads color settings ideal for sports games. ▪ Creator: Allows you to set Color Space to sRGB or DCI-P3, adjust the Gamma level (between 1.8 and 2.6). This mode is available only for SDR mode and will be disabled when HDR is on. ▪ Game 1/Game 2/Game 3: Enables you to customize the settings of Response Time, Gain, Offset, Hue, Saturation, and Dark Stabilizer for your gaming needs. ▪ Warm: Presents colors at lower color temperatures. The screen appears warmer with a red/yellow tint. ▪ Cool: Presents colors at higher color temperatures. The screen appears cooler with a blue tint. ▪ Custom Color: Enables you to manually adjust the color settings. Use the joystick to adjust Gain, Offset, Hue, and Saturation for creating your own preset color modes. <p>  NOTE: The feature is disabled when Console Mode is on. </p> <p>  NOTE: The feature is disabled when Smart HDR is activated and HDR content is displayed. </p>

Icon	Menu and submenu	Description
------	------------------	-------------



Game Enhance Mode

The feature offers three available functions to enhance your gameplay experience.

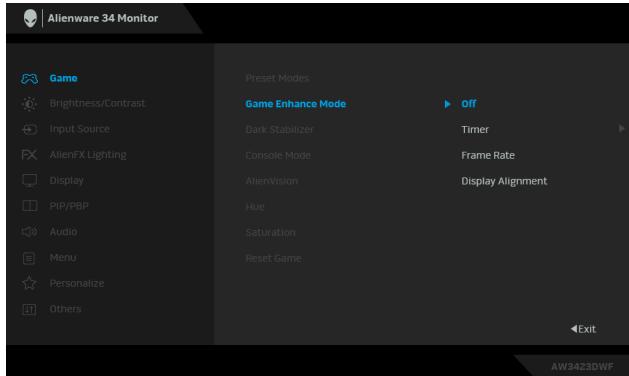

- **Off:** To disable the functions under **Game Enhance Mode**.
- **Timer:** To disable or enable the timer at the upper left corner of the display. The timer shows the time elapsed since the game starts. Select an option from the time-interval list to keep you aware of the remaining time.
- **Frame Rate:** To display the current frames per second when playing games. The higher the rate, the smoother the motion appears.
- **Display Alignment:** To help ensure the perfect alignment of the video contents from multiple displays. Pressing the joystick again will exit the **Display Alignment** mode.

Icon	Menu and submenu	Description
------	------------------	-------------



Dark Stabilizer

The feature improves the visibility in the dark gaming scenarios. The higher the value (between 0 to 3), the better visibility in dark area of the display image.

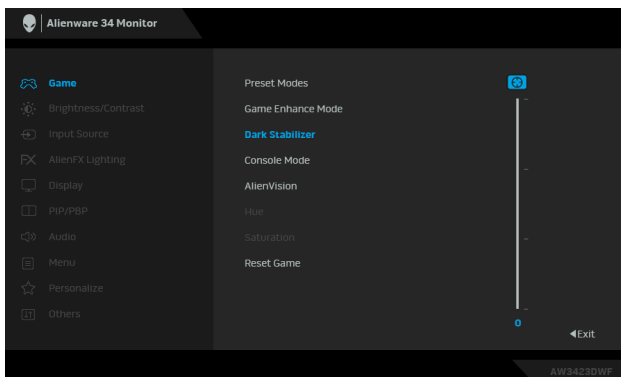

NOTE: The feature is disabled when Smart HDR or PIP/PBP is activated.

Console Mode Adjusts **Console Mode** to **On/Off**, **Color**, **Gamma**, or **Source Tone Map**. Activating the feature gives the best gaming experience when playing console games. For more information, see [Console mode](#).

- **On/Off:** Select to disable the functions under **Console Mode**.
- **Color:** RGB default 100, and this mode can adjust RGB from 0 - 100.
- **Gamma:** **Gamma** default is at center 2.2. Selecting this feature enables you to manually adjust **Gamma** from 1.8 - 2.6.
- **Source Tone Map:** Select to allow the HDR content to be tone mapped by the source device.

NOTE: Preset modes are not available when Console mode is turned to "on".

Icon	Menu and submenu	Description
------	------------------	-------------



AlienVision

AlienVision provides a few display modes for gaming scenarios. You can go through the options to see the preview. The default setting is **Off**.

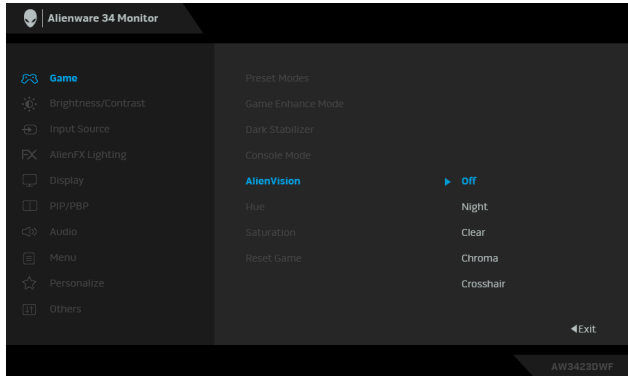





- **Night:** Identifies the objects clearly in dark game scenes.
- **Clear:** Cleans up visual artifacts to enhance the clarity in the daytime scenes.
- **Chroma:** Applies dynamic heatmaps in various scenes to help distinguish game objects from the background.
- **Crosshair:** Assists in aiming and predictive aiming with markings. Displays the crosshair throughout the game, helping improve aiming in the heat of the game.

Hue

This feature can shift the color of the video image to green or purple. This is used to adjust the desired flesh-tone color. Use the joystick to adjust the hue level from 0 to 100.

Higher levels increase the green shade of the video image, while lower levels increase the purple shade of the video image.

 **NOTE: This feature is available only when you select FPS, MOBA/RTS, SPORTS, or RPG preset mode.**

Icon	Menu and submenu	Description
	Saturation	<p>This feature can adjust the color saturation of the video image. Use the joystick to adjust the saturation level from 0 to 100.</p> <p>Higher levels increase the colorful appearance of the video image; while lower levels increase the monochrome appearance of the video image.</p> <p> NOTE: This feature is available only when you select FPS, MOBA/RTS, SPORTS, or RPG preset mode.</p>
	Reset Game	<p>Resets all settings under the Game menu to the factory defaults.</p>
	Brightness/Contrast	<p>Activates Brightness/Contrast adjustment.</p>
		
	Brightness	<p>Brightness adjusts the luminance of the backlight. Move the joystick to adjust the brightness level (minimum 0/maximum 100).</p> <p> NOTE: Manual adjustment of Brightness is disabled when Smart HDR is activated and HDR content is displayed.</p>
	Contrast	<p>Adjust Brightness first, and then adjust Contrast only if further adjustment is necessary. Move the joystick to adjust the contrast level (minimum 0/maximum 100). The Contrast feature adjusts the degree of difference between darkness and lightness on the monitor screen.</p>

Icon	Menu and submenu	Description
------	------------------	-------------



Input Source

Use this menu to select between the different video signals that may be connected to your monitor.

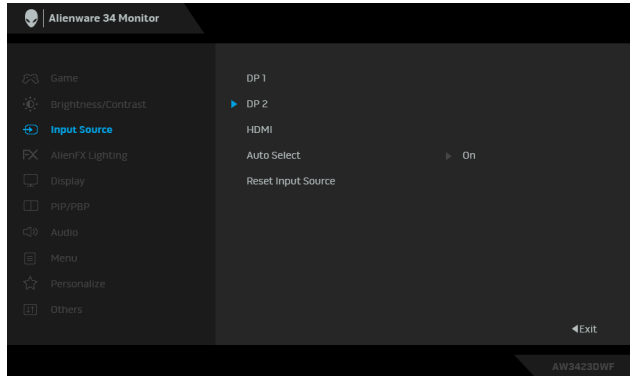

DP 1

Select the **DP 1** or **DP 2** input when you are using the DisplayPort (DP) connector. Press the joystick to confirm the selection.

DP 2

HDMI

Select the **HDMI** input when you are using the HDMI connector. Press the joystick to confirm the selection.

Auto Select

Automatically scans for available input sources. Press the joystick to confirm the selection.

Reset Input Source

Resets all settings under the **Input Source** menu to the factory defaults.

Icon	Menu and submenu	Description
FX	AlienFX Lighting	Adjusts the LED light settings for the Alienware logo, number graphic, and Power button.

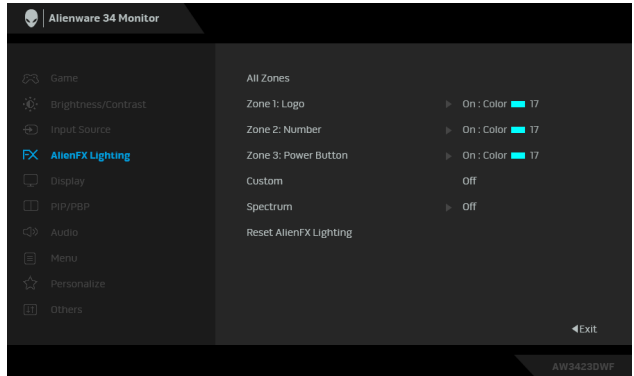

Before making any adjustments, select any or all of these 3 zones from the submenus. The following illustrations indicate the lighting zones.



Icon	Menu and submenu	Description
FX	All Zones	To specify an LED lighting color for the selected zone, select On , move the joystick to highlight Custom Color , and press the joystick to enter its submenu.
	Zone 1: Logo	
	Zone 2: Number	
	Zone 3: Power Button	

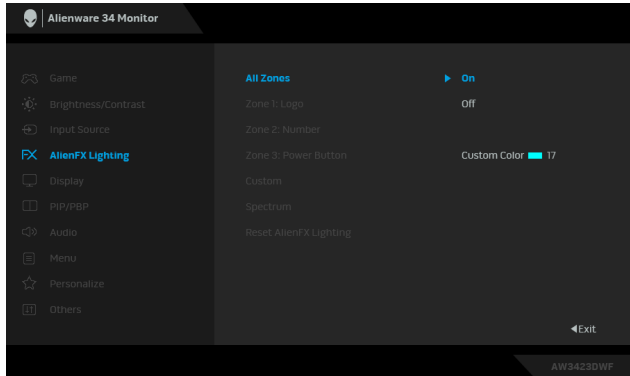

Then move the joystick to make a selection from the list of 20 available colors.

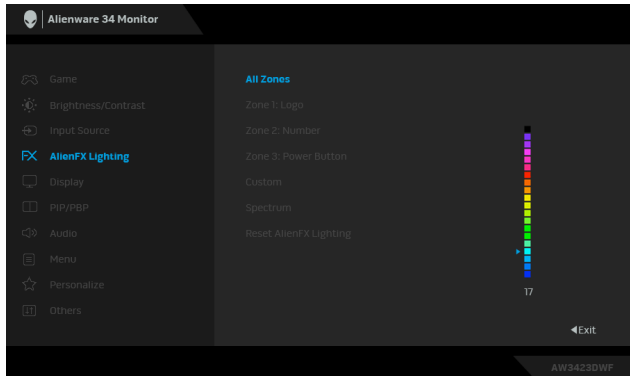

Icon	Menu and submenu	Description
------	------------------	-------------

FX

The following table depicts the color number and the RGB codes used for the 20 LED colors.

No.	R	G	B
1	0	0	0
2	38	0	180
3	51	0	198
4	195	0	195
5	186	16	123
6	194	0	65
7	185	0	0
8	166	51	0
9	185	96	0
10	195	140	0
11	130	219	0
12	62	223	0
13	40	223	0
14	0	195	0
15	0	205	25
16	0	205	45
17	10	230	180
18	0	101	247
19	0	25	247
20	0	0	255

To turn off the light for **All Zones/Zone 1/Zone 2**, select **Off**.

For **Zone 3**, you may specify to turn off the light when the monitor is in On or Standby mode.

 **NOTE: These features are available when Spectrum is disabled.**

Icon	Menu and submenu	Description
FX	Custom	It is a read-only menu. When you use Custom Color or Spectrum to make LED lighting adjustments, this menu status shows Off ; when you make the LED lighting adjustments through AlienFX application, the status shows On .
	Spectrum	The default setting is Off . When you select On , the AlienFX lights of 3 zones glow and change colors in the sequence of the color spectrum: red, orange, yellow, green, blue, indigo, and violet.

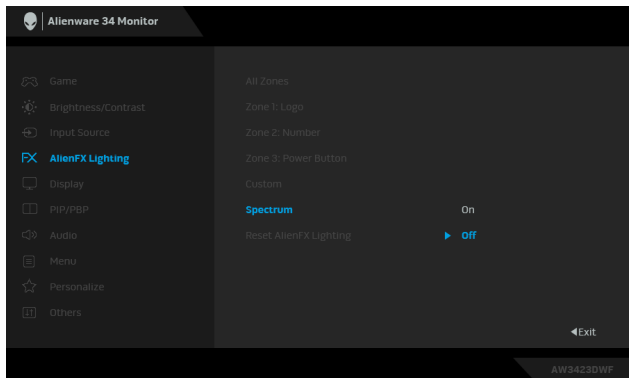

Reset AlienFX Lighting	Resets all settings under the AlienFX Lighting menu to the factory defaults.
-------------------------------	---

Icon**Menu and submenu****Description**

**Display**

Use the **Display** menu to adjust images.

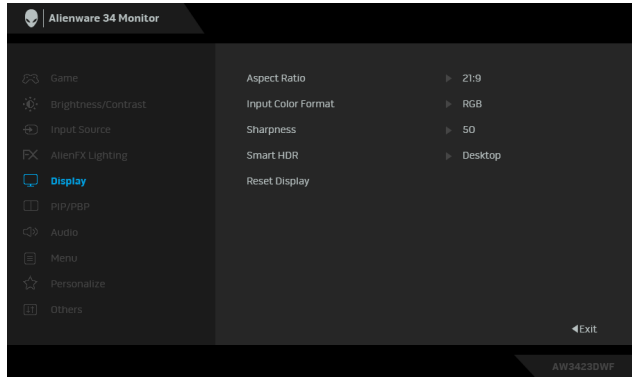

Aspect Ratio

Adjusts the image ratio to **21:9**, **Auto Resize**, or **4:3**.



NOTE: The feature is disabled when PIP/PBP is activated.

Input Color Format

Allows you to set the video input mode to:

- **RGB:** Select this option if your monitor is connected to a computer or a media player that supports RGB output.
- **YCbCr:** Select this option if your media player supports only YCbCr output.

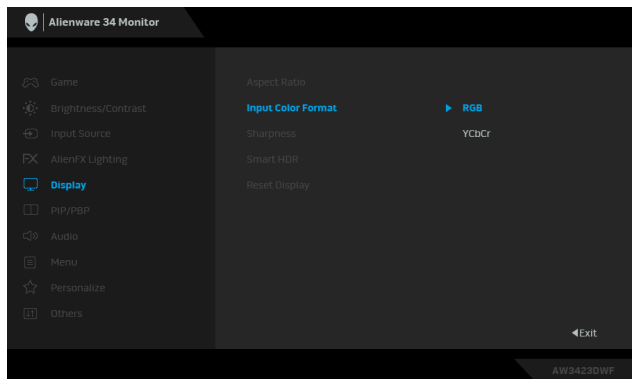

Sharpness

This feature can make the images look sharper or softer. Move the joystick to adjust the sharpness level from 0 to 100.

Icon	Menu and submenu	Description
------	------------------	-------------



Smart HDR



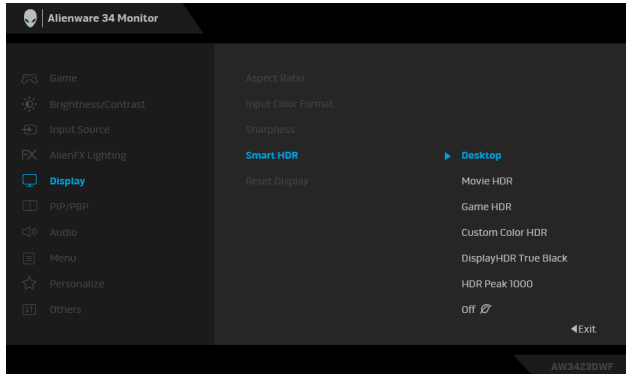

The **Smart HDR** (High Dynamic Range) feature enhances the display output by optimally adjusting contrast and the ranges of color and luminosity to resemble true-to-life visuals.



- **Desktop:** Suitable for using the monitor with a desktop computer.
- **Movie HDR:** Suitable for the playback of HDR video content.
- **Game HDR:** Suitable for playing HDR-compatible games. It displays more realistic scenes and makes the gaming experience immersive and entertaining.
- **Custom Color HDR:** Enables you to create your own HDR mode by adjusting the settings of **Contrast, Hue, and Saturation.**
- **DisplayHDR True Black:** Compliant with the DisplayHDR True Black standard, supporting a peak brightness of 400 cd/m².
- **HDR Peak 1000:** Suitable for playing the HDR content with a peak brightness of 1000 cd/m².

You can disable this function by selecting **Off**.

 **NOTE: When activating and deactivating Smart HDR, a blank screen is expected (about 5 seconds). This is a normal behavior as the monitor changes the display mode. Do not power cycle the monitor.**

Icon	Menu and submenu	Description
	Smart HDR	<p> NOTE: When the monitor is processing HDR content, Preset Modes and Brightness will be disabled.</p> <p> NOTE: The feature is disabled when PIP/PBP is activated.</p>
	Reset Display	Resets all settings under the Display menu to the factory defaults.
	PIP/PBP	This feature brings up a window displaying image from another input source.

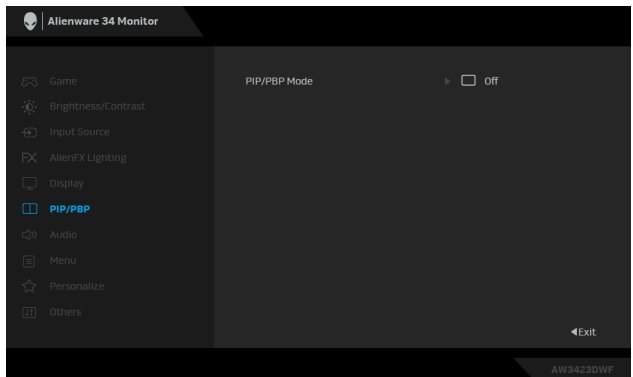

Main Window	Sub-Window		
	DP 1	DP 2	HDMI
DP 1	—	✓	✓
DP 2	✓	—	✓
HDMI	✓	✓	—

 **NOTE: In PBP mode, the images will be displayed at the center of the split windows.**

Icon	Menu and submenu	Description
------	------------------	-------------



PIP/PBP Mode

Allows you to choose a PBP or PIP mode from the preset list, which provides different sizes and positions of the sub-window. The options are shown in graphic format, giving a quick understanding of various layout settings. Press the joystick to confirm the selection. The default setting is **Off**.

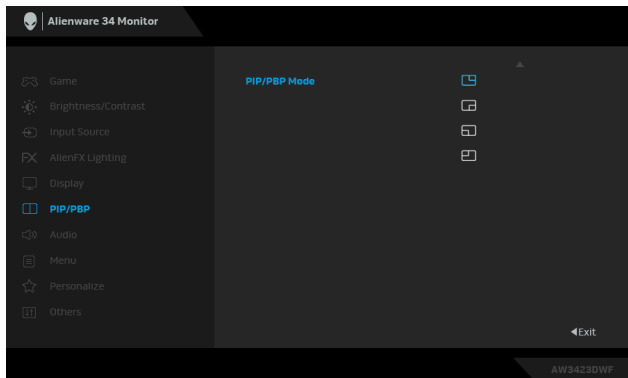
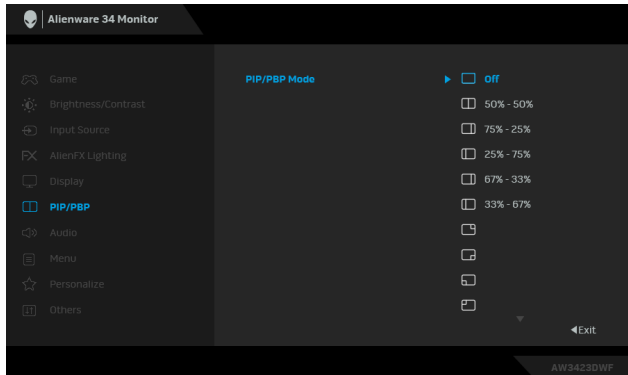







PIP/PBP (Sub)

Select between the different video signals that may be connected to your monitor for the PIP/PBP sub-window. Press the joystick to confirm the selection.

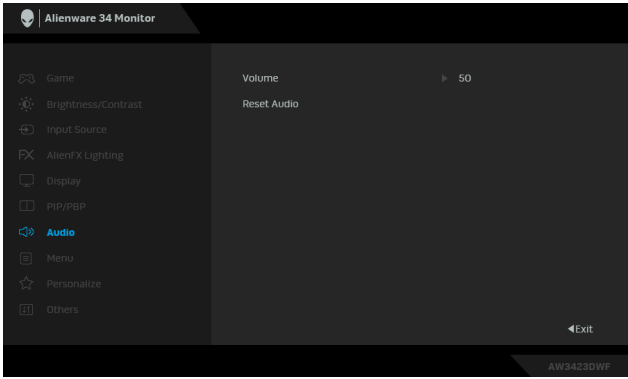

NOTE: This option is available only when the PIP/PBP mode is enabled.

Icon	Menu and submenu	Description
	Video Swap	<p>Select to swap videos between main window and sub-window in PIP/PBP mode.</p> <p> NOTE: This option is available only when the PIP/PBP mode is enabled.</p>
	Audio	<p>Allows you to set the audio source from the main window or the sub-window.</p> <p> NOTE: This option is available only when the PIP/PBP mode is enabled.</p>
	Contrast (Sub)	<p>Select to adjust the contrast level of the picture in PIP/PBP mode.</p> <p>Move the joystick to adjust the contrast level from 0 to 100.</p> <p> NOTE: This option is available only when the PIP/PBP mode is enabled.</p>
	Audio	
	Volume	<p>Move the joystick to adjust the volume level of headphone output (minimum 0/maximum 100).</p>
	Reset Audio	<p>Resets all settings under the Audio menu to the factory defaults.</p>

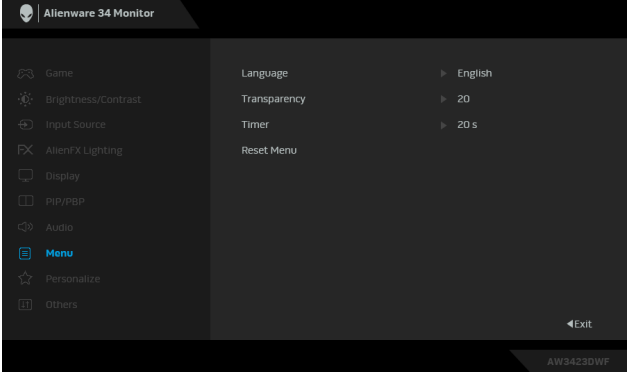
Icon	Menu and submenu	Description
	Menu	Use this menu to adjust the settings of the OSD, such as, the languages of the OSD, the amount of time the menu remains on screen, and so on.
		
	Language	Sets the OSD display to one of the eight languages: English, Spanish, French, German, Brazilian Portuguese, Russian, Simplified Chinese, or Japanese.
	Transparency	Move the joystick to change the menu transparency (minimum 0/maximum 100).
	Timer	Sets the length of time for the OSD to remain active after your last operation with the joystick. Move the joystick to adjust the slider in 1 second increment, from 5 to 60 seconds.
	Reset Menu	Resets all settings under the Menu menu to the factory defaults.

Icon

Menu and submenu

Description



Personalize

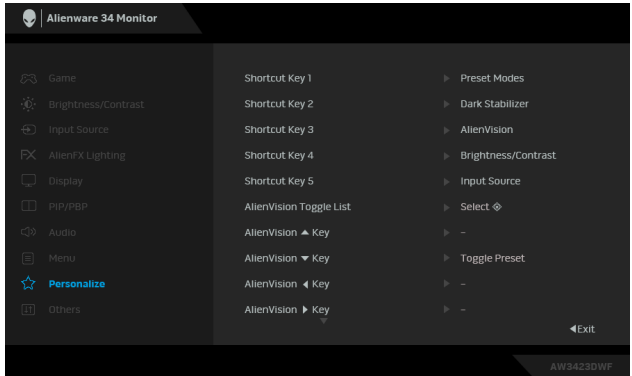

Shortcut Key 1

Shortcut Key 2

Shortcut Key 3

Shortcut Key 4

Shortcut Key 5

Allows you to choose a feature from the provided list and set it as a shortcut key. The list includes **Preset Modes, Game Enhance Mode, Dark Stabilizer, AlienVision, Brightness/Contrast, Input Source, Aspect Ratio, Smart HDR, PIP/PBP Mode, Video Swap, and Volume.** Press the joystick to confirm the selection.

AlienVision Toggle List

Select to specify the preferred modes for **AlienVision** shortcut function in the Menu Launcher and **AlienVision** 4-direction keys. Press the joystick again to select or not select the mode.

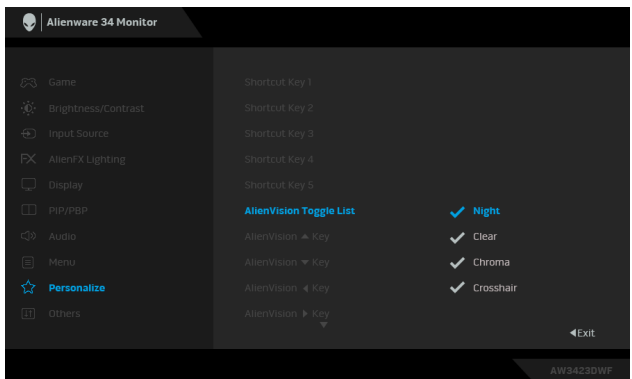

Icon	Menu and submenu	Description
☆	AlienVision ▲ Key	You can define the joystick movements for AlienVision preset modes; therefore, when you move the joystick at any specified direction, a particular AlienVision mode will be activated.
	AlienVision ▼ Key	
	AlienVision ◀ Key	If you select Toggle Preset , you can toggle through the modes specified in AlienVision Toggle List and the Off option.
	AlienVision ▶ Key	By factory default, the AlienVision ▼ Key is enabled and set to Toggle Preset .
	USB	Allows you to enable or disable USB function during monitor standby mode.

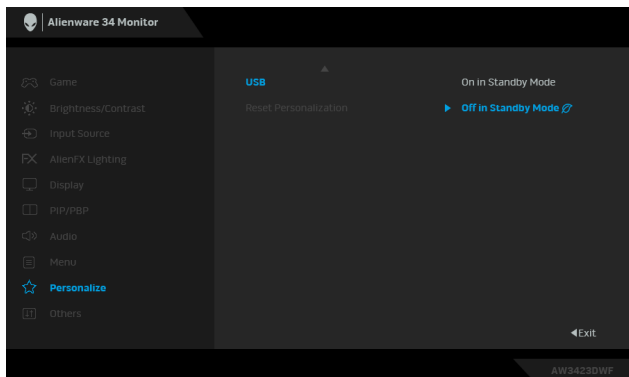

Reset Personalization	Resets all settings under the Personalize menu to the factory defaults.
------------------------------	--

Icon**Menu and submenu****Description**

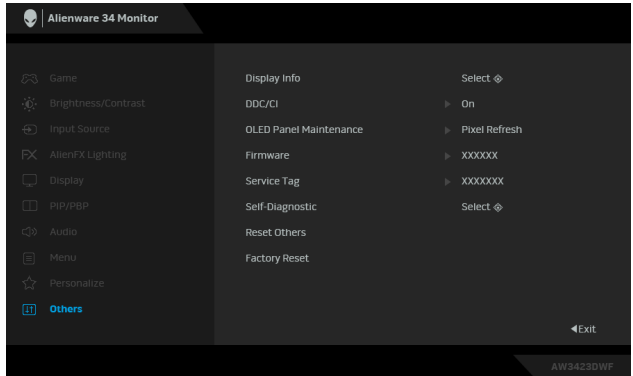
**Others**

Display Info

Displays the monitor's current settings.

DDC/CI

DDC/CI (Display Data Channel/Command Interface) allows your monitor parameters (brightness, color balance, etc.) to be adjustable via the software on your computer. You can disable this feature by selecting **Off**.

Enable this feature for best user experience and optimum performance of your monitor.

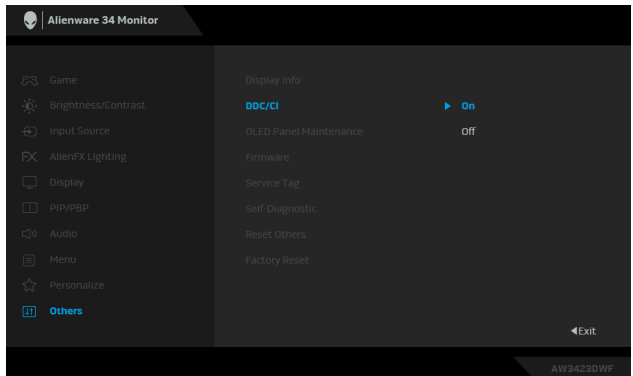

Icon	Menu and submenu	Description
------	------------------	-------------



OLED Panel Maintenance

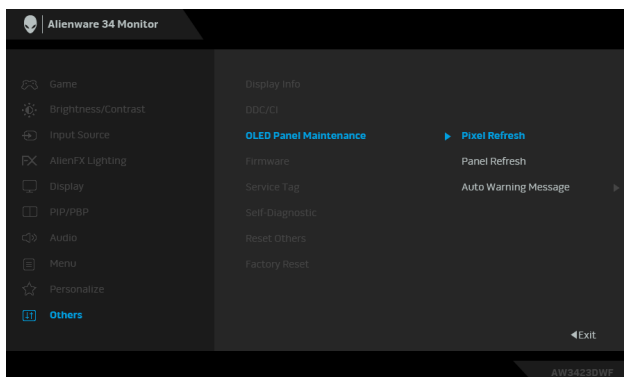

The feature prevents the screen from image retention by offering these functions:



- **Pixel Refresh:** To reduce temporary image retention on the screen, you can manually activate this function after using the monitor for a couple of hours. Alternatively, the function will be activated automatically when you have used the monitor for 4 hours/20 hours. The process takes approximately 6 to 8 minutes to complete.

 **NOTE: The power LED indicator blinks slowly in green during the refresh process.**

 **NOTE: If the accumulated usage time exceeds 4 hours, Pixel Refresh will be automatically activated when the monitor goes into Standby mode.**

- **Panel Refresh:** To prevent permanent image retention caused by static content when you use the monitor for 1500 hours, you can manually activate this function to refresh the pixels. Alternatively, the function will be activated automatically when the accumulated usage time exceeds the factory default setting (1500 hours). The process takes approximately an hour to complete.

 **NOTE: The power LED indicator blinks slowly in red during the refresh process.**

Icon	Menu and submenu	Description
	OLED Panel Maintenance	<p> NOTE: To obtain a better performance of Panel Refresh, activate the function within a temperature range of 0°C to 45°C.</p> <ul style="list-style-type: none"> ▪ Auto Warning Message: To automatically provide the warning messages as reminders whenever the accumulated usage time exceeds the factory default settings. The default setting is On. If you select Off, the warning message will not appear, yet the calculation of accumulated usage hours continues. <p> NOTE: If Auto Warning Message is set to Off and the accumulated usage time exceeds 4 hours, Pixel Refresh will be automatically activated when you press the power button of the monitor or the monitor goes into Standby mode.</p>
	Firmware	Displays the firmware version of your monitor.
	Service Tag	Displays the Service Tag of your monitor. The Service Tag is a unique alphanumeric identifier that is required when you contact Dell technical support, access warranty information, search for latest drivers on Dell support website and so on.
	Self-Diagnostic	<p>Select to initiate the following self-diagnostic process:</p> <ol style="list-style-type: none"> 1. When initiated, a gray screen appears. 2. Carefully inspect the screen for abnormalities. 3. Move the joystick. The color of the screen changes to red. 4. Inspect the display for any abnormalities. 5. Repeat step 3 and step 4 to inspect the display in green, blue, black, white, and text screens. <p>The test is complete when the text screen appears. Press the joystick to end the testing process.</p>
	Reset Others	Resets all settings under the Others menu to the factory preset values.
	Factory Reset	Resets all OSD settings to the factory defaults.

Console mode

Console Mode is specifically designed with the excellent picture quality at a fast response time and a high frame rate of 120Hz to give the best console game experience. It can support up to 4K resolution in this QD-OLED monitor.

Support timing

Display mode	Horizontal frequency (kHz)	Vertical frequency (Hz)	Pixel clock (MHz)	Sync polarity (Horizontal/Vertical)
VESA, 640 x 480	31.47	59.94	25.18	-/-
VESA, 640 x 480	37.50	75	31.50	-/-
720 x 400	31.47	70.08	28.32	-/+
VESA, 800 x 600	37.88	60.32	40	+/+
VESA, 800 x 600	46.88	75	49.50	+/+
VESA, 1024 x 768	48.36	60	65	-/-
VESA, 1024 x 768	60.02	75.03	78.75	+/+
VESA, 1152 x 864	67.50	75	108	+/+
VESA, 1280 x 1024	63.98	60.02	108	+/+
VESA, 1280 x 1024	79.98	75.03	135	+/+
VESA, 1600 x 900	60	60	108	+/+
VESA, 1920 x 1080	67.50	60	148.50	+/+
1920 x 1080	135	120	297	+/+
2560 x 1440	88.79	59.95	241.50	+/-
2560 x 1440	183	120	497.75	+/-
3440 x 1440	88.82	59.97	319.75	+/-
3440 x 1440	150.97	99.98	538.37	+/-
3840 x 2160	112.50	50	594	+/+
3840 x 2160	135	60	594	+/+

OSD warning message

When the monitor does not support a particular resolution mode, you will see the following message:

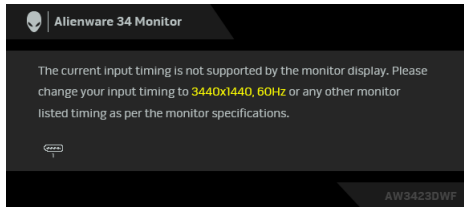

This means that the monitor cannot synchronize with the signal that it is receiving from the computer. See [Monitor specifications](#) for the horizontal and vertical frequency ranges addressable by this monitor. The recommended mode is **3440 x 1440**.

When you adjust the **Brightness** level above the default level for the first time, the following message appears:

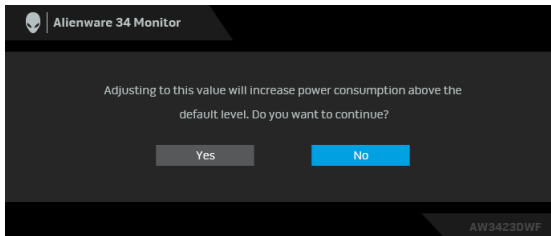

NOTE: If you select **Yes**, the message will not appear the next time you changes the **Brightness** setting.

When you change the default setting of power saving features for the first time, such as **Smart HDR** or **USB**, the following message appears:

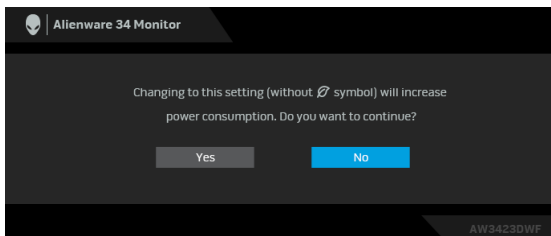

NOTE: If you select **Yes** for either of the features mentioned above, the message will not appear the next time you change the settings of these features. When you perform a factory reset, the message will appear again.

When the monitor goes into Standby mode, the following message appears:



Activate the computer and wake up the monitor to gain access to the **OSD**. The OSD functions only in the normal operation mode. If you press the joystick during the Standby mode, the following message will appear depending on the selected input:

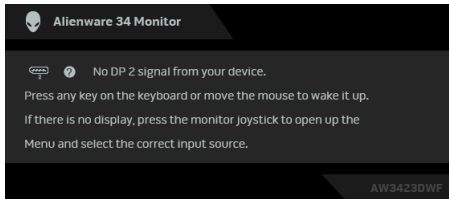

Activate the computer and wake up the monitor to gain access to the **OSD**.

NOTE: The message may be slightly different according to the connected input signal.

If DisplayPort or HDMI input is selected and the corresponding cable is not connected, the following message will appear:

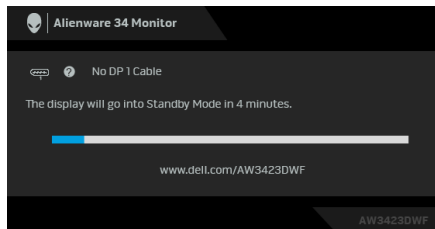

NOTE: The message may be slightly different according to the selected input signal.

Activate the computer and wake up the monitor to gain access to the **OSD**.

You will see the following message before the **DDC/CI** function is disabled:

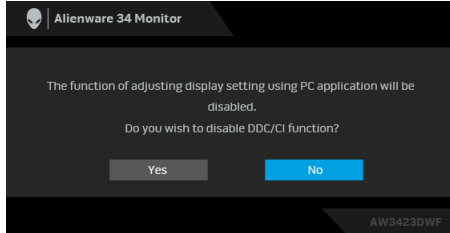

When **Pixel Refresh** is selected, the following message appears:

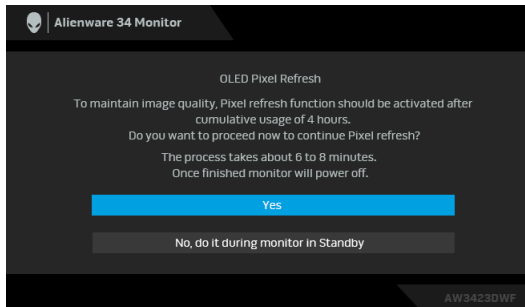

Once you select **Yes**, the monitor will be turned off and the refresh process will run automatically. The process takes approximately 6 to 8 minutes to complete. When the monitor is turned on after 4 hours of cumulative usage, the **Pixel Refresh** function runs automatically and notifies you with the following message:

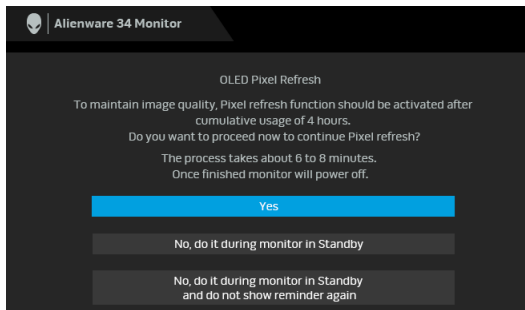

Select **Yes**, and the refresh process will run automatically after the monitor is turned off. The process takes approximately 6 to 8 minutes to complete.

When the monitor is turned on after 20 hours of cumulative usage, the **Pixel Refresh** function runs automatically and notifies you with the following message:

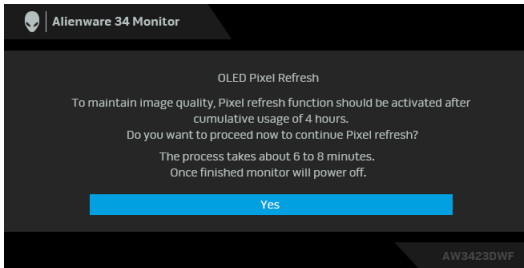

Select **Yes**, and the refresh process will run automatically after the monitor is turned off. The process takes approximately 6 to 8 minutes to complete.

When **Panel Refresh** is selected or the cumulative usage time of the monitor is more than 1500 hours, the following message appears:

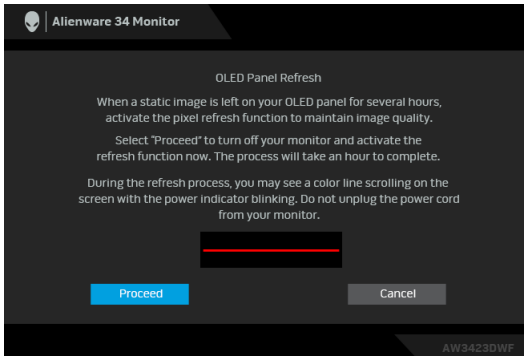

Select **Proceed**, and the refresh process will run automatically. The process takes approximately an hour to complete.

If you press the power button during the process of running **Pixel Refresh** or **Panel Refresh**, the following message appears:

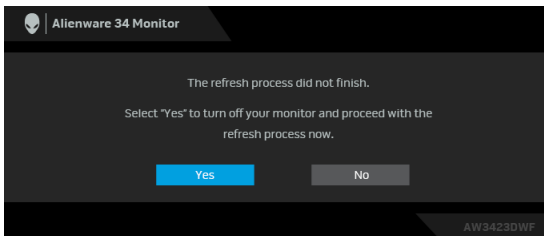

When you set **Auto Warning Message** to **Off**, the following message appears:

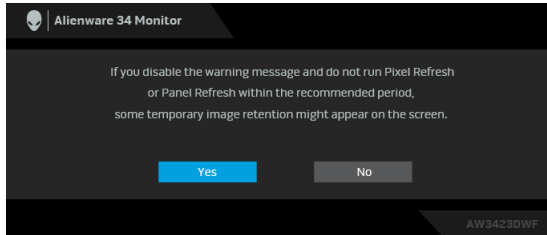

When **Factory Reset** is selected, the following message appears:

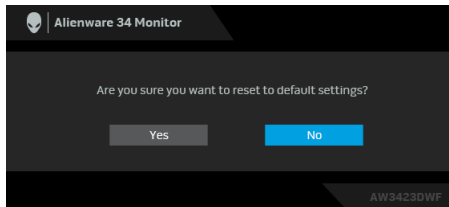

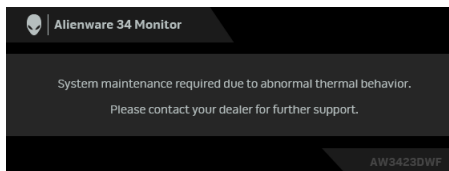

When the built-in thermal sensor detects an abnormality, the following message appears every 30 minutes:



For more information, see [Troubleshooting](#).

Locking the control buttons

You can lock the monitor control buttons to prevent access to the OSD menu and/or power button.

1. Move and hold the joystick forward/backward/left/right for about 4 seconds until a pop-up menu appears
2. Move the joystick to select one of the following options:
 -  : The OSD menu settings are locked and not accessible.
 -  : The power button is locked.
 -  : The OSD menu settings are not accessible and the power button is locked.

3. Press the joystick to confirm the configuration.

To unlock, move and hold the joystick forward/backward/left/right for about 4 seconds until a menu appears on the screen, and then select  to unlock and close the pop-up menu.

Setting the maximum resolution

 **NOTE: The steps may vary slightly depending on the version of Windows you have.**

To set the maximum resolution for the monitor:

In Windows 8.1:

1. For Windows 8.1, select the Desktop tile to switch to classic desktop.
2. Right-click on the desktop and click **Screen resolution**.
3. If you have more than one monitor connected, ensure that you select **AW3423DWF**.
4. Click the **Screen Resolution** dropdown list and select **3440 x 1440**.
5. Click **OK**.

In Windows 10 and Windows 11:

1. Right-click on the desktop and click **Display settings**.
2. If you have more than one monitor connected, ensure to select **AW3423DWF**.
3. Click the **Display Resolution** dropdown list and select **3440 x 1440**.
4. Click **Keep changes**.

If you do not see 3440 x 1440 as an option, you must update your graphics driver to the latest version. Depending on your computer, complete one of the following procedures:

If you have a Dell desktop or a laptop:

- Go to www.dell.com/support, enter your service tag, and download the latest driver for your graphics card.

If you are using a non-Dell computer (laptop or desktop):

- Go to the support site for your non-Dell computer and download the latest graphic card drivers.
- Go to the graphics card's website and download the latest graphic card drivers.

Requirements to view or playback HDR content

(1) Through Ultra BluRay DVD or Game consoles

Ensure the DVD player or Game console is HDR capable, such as Panasonic DMP-UB900, Xbox One S, and PS4 Pro.

(2) Through a PC

Ensure the graphics card used is HDR capable, i.e., it has a HDMI 2.0a (with HDR option) compliant port and HDR graphics driver is installed. HDR capable application program must be used, such as Cyberlink PowerDVD 17, Windows 10 Movies & TV app.

 **NOTE: To download and install the latest graphics driver that supports HDR content playback on your Dell desktop or laptop, see <https://www.dell.com/support/drivers>.**

NVIDIA

For a full range of HDR capable NVIDIA graphics cards, see www.nvidia.com.

Ensure to download driver that supports Full Screen Playback mode (e.g. PC games, UltraBluRay players), HDR on Win 10 Redstone 2 OS: 381.65 or later.

AMD

For a full range of HDR capable AMD graphics cards, see www.amd.com. Read the HDR driver support information and download the latest driver.

Intel (Integrated Graphics)

HDR capable processor: CannonLake or later

Suitable HDR player: Windows 10 Movies & TV app

Operating System (OS) with HDR support: Windows 10 Redstone 3

Driver with HDR support: see downloadcenter.intel.com for the latest HDR driver

 **NOTE: HDR playback through OS (e.g. playback of HDR in a window within desktop) requires Windows 10 Redstone 2 or later with appropriate application program such as PowerDVD 17. Playing back protected content will require appropriate DRM software and/or hardware, e.g. Microsoft Playready. For support information, see <https://www.support.microsoft.com>.**

Using the tilt, swivel, and vertical extension

- NOTE:** The following instructions are applicable only for the stand that was shipped with your monitor. If you are attaching a stand that you purchased from any other source, follow the setup instructions that were included with the stand.

Tilt and swivel extensions

With the stand attached to the monitor, you can tilt and swivel the monitor for the most comfortable viewing angle.

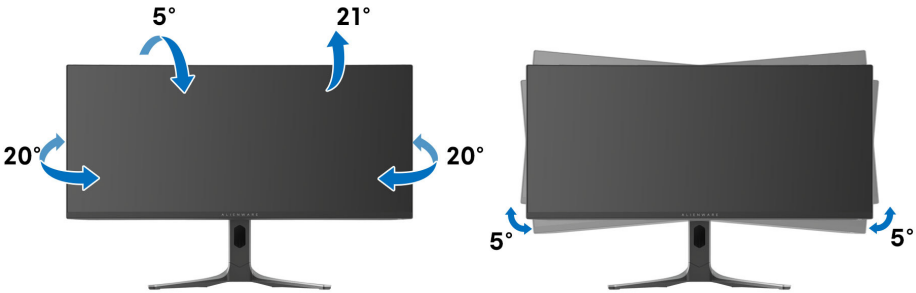

- NOTE:** The stand is not installed at the factory when shipped.
- NOTE:** The slant angle of this monitor is between -5° and $+5^\circ$, not allowing for pivot movements.

Vertical extension

- NOTE:** The stand extends vertically up to 110 mm. The following figure illustrates how to extend the stand vertically.



Using AlienFX application

You can configure the LED lighting effects across multiple distinct zones on your Alienware monitor and customize advanced features for different gaming types through AlienFX in Alienware Command Center (AWCC).

 **NOTE: If you have an Alienware Gaming desktop or laptop, you can directly access AWCC.**

 **NOTE: For more information, see Alienware Command Center Online Help by clicking the [Help](#) icon  on the top right of the AWCC window.**

Prerequisites

Before installing the AWCC on a non-Alienware system:

- Ensure that the OS of your computer is Windows 10 R3 or later.
- Ensure your Internet connection is active.
- Ensure that the supplied USB 3.2 Gen 1 (5 Gbps) upstream cable is connected to both the Alienware monitor and the computer.

Installing AWCC through Windows update

1. The AWCC application is downloaded and will be automatically installed. The installation takes a few minutes to complete.
2. Navigate to the program folder to ensure that the installation is successful. Alternatively, you can find the AWCC application in the **Start** menu.
3. Launch AWCC and perform the following steps to download the additional software components:
 - In the **Settings** window, click **Windows Update**, and then click **Check for updates** to check the Alienware driver update progress.
 - If the driver update is not responding in your computer, install AWCC from the Dell Support website.

Installing AWCC from the Dell Support website

1. Enter AW3423DWF in the query field at www.dell.com/support/drivers, and download the latest version of Alienware Command Center Application.
2. Navigate to the folder in which you saved the setup files.
3. Double-click the setup file and follow the on-screen instructions to complete the installation.

Navigating the AlienFX window

In the AWCC home screen, click **FX** in the top menu bar to access the home screen of AlienFX.



The following table describes the functions and features on the home screen:

Callout	Function	Description
A	CREATE NEW THEME...	Click + and then enter a name in the text box to add a theme.
B	Edit controls	<ul style="list-style-type: none"> ▪ EDIT: Provides options for you to customize lighting adjustments for your theme. ▪ GO DIM: Makes the light dimmer. ▪ GO DARK: Turns off the light.
C	Theme components	You can use these components (LIGHTING and SETTINGS) to make the selected theme as an active theme.
D	THEMES list	Displays the themes in list view or grid view.
E	Background controls	Adjusts the background animation effects.
F	Help	Click to access the AWCC Online Help.
G	Window controls	You can use the buttons to minimize, maximize, or restore the size of the window. When × is selected, the application will close.

When you start to customize a theme, you should see the following screen:



Screen with the front view of monitor



Screen with the back view of monitor

The following table describes the functions and features on the screen:

Callout	Function	Description
H	LIGHTING and SETTINGS panels	<p>Click the panel tab and use the provided controls to set up lighting effects and advanced game features for a theme.</p> <p>See Setting the lighting effects and Settings for details.</p> <p> NOTE: The LIGHTING panel appears only when the supplied USB 3.2 Gen 1 (5 Gbps) upstream cable is connected to both the Alienware monitor and the computer.</p>
I	SAVE THEME	Click to save all adjustments and changes for the theme.
J	Zone selection	To make adjustments for a single zone, click the specific check box. To make adjustments for all zones, select the All Zones check box.
K	Live preview	<p>Under the LIGHTING panel, you can see the lighting zones of the monitor with numbered callouts. You may select a single zone by clicking the number on the image. When you make lighting adjustments, the preview of the monitor displays the new effects simultaneously.</p> <p>Under the SETTINGS panel, you can see the applied effect of AlienVision displayed in this window by toggling the PREVIEW switch to ON.</p>
L	Thumbnails	Displays the thumbnails of the Alienware monitors connected to your computer when you are under the LIGHTING panel. The image displayed in the live preview area is selected from this thumbnail list.

Creating a theme

To create a theme with your preferred lighting effects and the in-game visibility:

1. Launch AWCC.
2. Click **FX** in the top menu bar to access the home screen of AlienFX.
3. In the top-left corner of the window, click  to create a new theme.
4. In the **CREATE NEW THEME** text box, type the theme name.
5. In the **LIGHTING** panel, specify the lighting zone(s) for which you want to make lighting adjustments by:
 - selecting the zone check box(es) above the live preview area, or
 - clicking the numbered callout on the image of monitor
6. Select your preferred lighting effects from the dropdown list. For more details, see [Setting the lighting effects](#).
7. In the **SETTINGS** panel, configure the custom gaming features. For more details, see [Settings](#).
8. Repeat step 5 to step 7 to make more configuration options available to your preference.
9. When done, click **SAVE THEME**. A toast notification appears in the right-bottom corner of the screen.

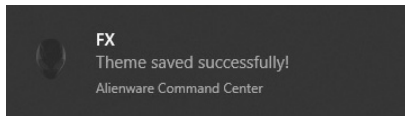

Setting the lighting effects





The **LIGHTING** panel provides various lighting effects. You may click **Effect** to open a dropdown list with available options.

 **NOTE: The LIGHTING panel appears only when the supplied USB 3.2 Gen 1 (5 Gbps) upstream cable is connected to your Alienware monitor and computer.**

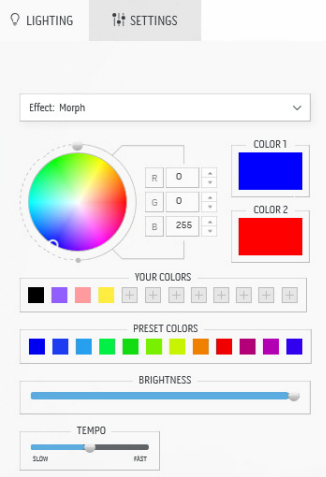

 **NOTE: The options displayed may vary depending on the lighting zone(s) you specified.**

The following table provides an overview of different options:

Morph	Description
	<p>The effect changes the light color into another through a seamless transition.</p> <ol style="list-style-type: none">1. Pick a preferred color from the color palette or the list of PRESET COLORS. The selected color and its RGB color codes will be displayed on the right field. <p> NOTE: To change the color, use the up and down arrow buttons beside the R/G/B boxes to edit the color codes.</p> <ol style="list-style-type: none">2. To add the selected color to the list of YOUR COLORS for quick access in the future, click . At most 12 colors can be added to the list. <p> NOTE: To remove an existing color chip from the list, right-click on it.</p> <ol style="list-style-type: none">3. Repeat the previous steps to specify Color 2 to be the ending light color.4. Drag the BRIGHTNESS slider to adjust the brightness of the color.5. Drag the TEMPO slider to adjust the transition speed.

Pulse

Description

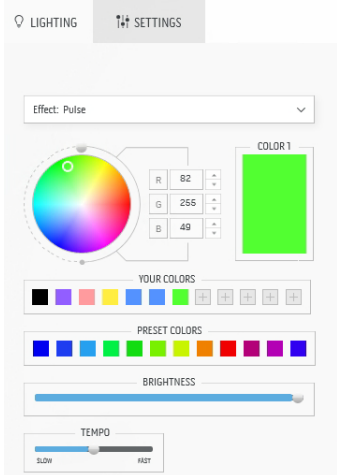

The effect makes the light flash with a short pause.

1. Pick a preferred color from the color palette or the list of **PRESET COLORS**. The selected color and its RGB color codes will be displayed on the right field.

 **NOTE: To change the color, use the up and down arrow buttons beside the R/G/B boxes to edit the color codes.**

2. To add the selected color to the list of **YOUR COLORS** for quick access in the future, click \oplus . At most 12 colors can be added to the list.

 **NOTE: To remove an existing color chip from the list, right-click on it.**

3. Drag the **BRIGHTNESS** slider to adjust the brightness of the color.
4. Drag the **TEMPO** slider to adjust the pulsing speed.

Color

Description

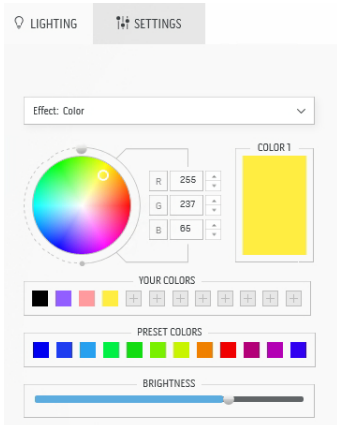

The lights will light in a single static color.

1. Pick a preferred color from the color palette or the list of **PRESET COLORS**. The selected color and its RGB color codes will be displayed on the right field.

 **NOTE: To change the color, use the up and down arrow buttons beside the R/G/B boxes to edit the color codes.**

2. To add the selected color to the list of **YOUR COLORS** for quick access in the future, click \oplus . At most 12 colors can be added to the list.

 **NOTE: To remove an existing color chip from the list, right-click on it.**

3. Drag the **BRIGHTNESS** slider to adjust the brightness of the color.

Spectrum

Description

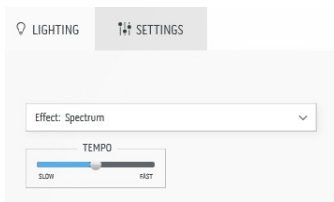

The effect makes the light change in sequence of spectrum: red, orange, yellow, green, blue, indigo, and violet.

You can drag the **TEMPO** slider to adjust the transition speed.

 **NOTE:** The option is available only when you select All Zones to make lighting adjustments.

Breathing

Description

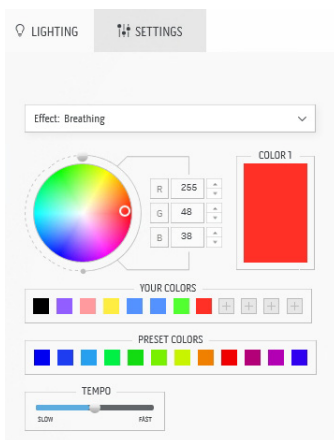

The effect makes the light change from bright to dim.

1. Pick a preferred color from the color palette or the list of **PRESET COLORS**. The selected color and its RGB color codes will be displayed on the right field.

 **NOTE:** To change the color, use the up and down arrow buttons beside the R/G/B boxes to edit the color codes.

2. To add the selected color to the list of **YOUR COLORS** for quick access in the future, click . At most 12 colors can be added to the list.
3. Drag the **TEMPO** slider to adjust the transition speed.

Static Default Blue

Description

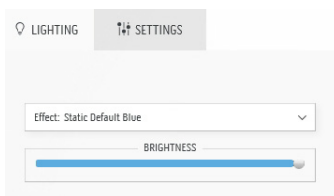

This effect makes the lights glow solid blue.

You can drag the **BRIGHTNESS** slider to change the intensity of the color from strong to light.

 **NOTE:** The option is available only when you select All Zones to make lighting adjustments.

Settings

The **SETTINGS** panel has two main elements – **AlienVision** and **Game**. To customize vision mode designs, see [Customization of AlienVision](#); to adjust advanced gaming features, see [Game configuration](#).

Customization of AlienVision

1. Click the **AlienVision** button.
2. Select a vision mode from the **ALIENVISION** dropdown list.





- **Night:** Improves contrast and clarity during dark game scenes.
- **Clear:** Improves and enhances the details and clarity in a day game scene.
- **Chroma:** Dynamically applies a heat map to any game environment to help differentiate game objects from the background.
- **Crosshair:** Ensures that a custom crosshair is always visible so as to assist in aiming for those tougher fights.

 **NOTE: To check the preview of applying the AlienVision effects, toggle the PREVIEW switch to the ON state.**

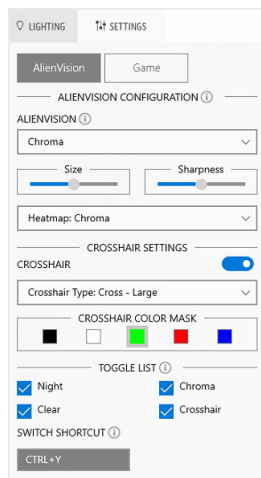
3. Customize a selected vision mode with the features displayed.



 **NOTE: The available features of each mode are slightly different.**

Feature	Description
Size	<p>Drag the slider to enlarge the AlienVision window or resume it to the default size.</p> <p> NOTE: This feature is not available for the Crosshair mode.</p>
Sharpness	<p>Drag the slider to adjust the sharpness level of the pictures in the AlienVision window.</p> <p> NOTE: This feature is not available for the Crosshair mode.</p>
Heatmap	<p>Select a heatmap effect from the dropdown list and apply it on the in-game objects in the AlienVision window.</p> <p> NOTE: This feature is available only for the Chroma mode.</p>
Crosshair settings	<p>Select the type of crosshair that matches the game play from the Crosshair Type dropdown list and pick a preferred color from the CROSSHAIR COLOR MASK options.</p> <p>For the Night, Clear, and Chroma modes, toggle the CROSSHAIR switch to turn on or off the feature.</p>

Toggle list

In the **TOGGLE LIST** section, you can select at least one or more vision modes to set up the **AlienVision** toggle list. You can toggle through the list during game play. To quickly cycle through the different vision modes selected in the toggle list, you can define a shortcut key.

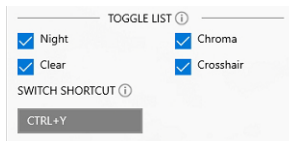

Game configuration

You can enhance the gameplay experience by adjusting the provided features.

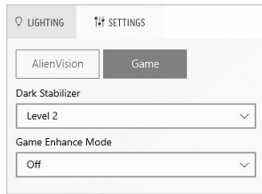

Feature	Description
Dark Stabilizer	Refer to Dark Stabilizer .
Game Enhance Mode	Refer to Timer and Frame Rate .

Troubleshooting

The following table provides the information about the problems you might encounter and the possible solutions:

What you experience	Possible solution
No LIGHTING panel	Ensure that the supplied USB 3.2 Gen 1 (5 Gbps) upstream cable is properly connected to your monitor and computer.
No SETTINGS panel	<ul style="list-style-type: none">▪ Check whether the signal cable is plugged in properly. Re-plug the signal cable if necessary.▪ Reboot your computer.

Troubleshooting

⚠ WARNING: Before you begin any of the procedures in this section, follow the [Safety instructions](#).

Self-test

Your monitor provides a self-test feature that allows you to check whether your monitor is functioning properly. If your monitor and computer are properly connected but the monitor screen remains dark, run the monitor self-test by performing the following steps:

1. Turn off both your computer and the monitor.
2. Unplug the video cable from the computer.
3. Turn on the monitor.

✍ NOTE: A dialog box should appear on the screen, indicating that the monitor is working correctly and it is not receiving a video signal. While in self-test mode, the power LED remains blue (default color).

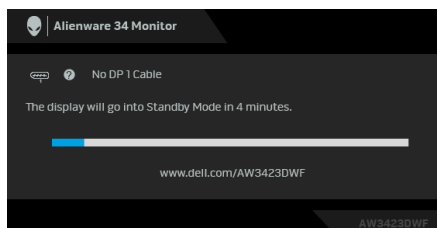

✍ NOTE: This dialog box also appears during normal operation, if the video cable is disconnected or damaged.

4. Turn off your monitor and reconnect the video cable; then turn on both your computer and the monitor.

After performing the above steps, if the monitor displays no video output, then the problem may be with the graphics card or the computer.

Common problems

The following table contains general information about common monitor problems you might encounter and the possible solutions:

Common symptoms	What you experience	Possible solutions
No video/ power LED off	No picture	<ul style="list-style-type: none">▪ Ensure that the video cable connecting the monitor and the computer is properly connected and secure.▪ Verify that the power outlet is functioning properly using any other electrical equipment.▪ Ensure that the power button is depressed fully.▪ Ensure that the correct input source is selected in the Input Source menu.
No video/ power LED on	No picture or no brightness	<ul style="list-style-type: none">▪ Increase brightness and contrast controls in the Brightness/Contrast menu.▪ Perform monitor self-test feature check.▪ Check for bent or broken pins in the video cable connector.▪ Run the built-in diagnostics.▪ Ensure that the correct input source is selected in the Input Source menu.
Poor focus	Picture is fuzzy, blurry, or ghosting	<ul style="list-style-type: none">▪ Eliminate video extension cables.▪ Reset the monitor to factory settings.▪ Change the video resolution to the correct aspect ratio.
Shaky/jittery video	Wavy picture or fine movement	<ul style="list-style-type: none">▪ Reset the monitor to factory settings.▪ Check environmental factors.▪ Relocate the monitor and test in another room.

Common symptoms	What you experience	Possible solutions
Missing pixels	OLED screen has spots	<ul style="list-style-type: none"> ▪ Cycle power On-Off. ▪ Pixel that is permanently off is a natural defect that can occur in OLED technology. ▪ For more information on Dell Monitor Quality and Pixel Policy, see www.dell.com/pixelguidelines.
Stuck-on pixels	OLED screen has bright spots	<ul style="list-style-type: none"> ▪ Cycle power On-Off. ▪ Pixel that is permanently off is a natural defect that can occur in OLED technology. ▪ For more information on Dell Monitor Quality and Pixel Policy, see www.dell.com/pixelguidelines.
Brightness problems	Picture too dim or too bright	<ul style="list-style-type: none"> ▪ Reset the monitor to factory settings. ▪ Adjust brightness and contrast controls in the Brightness/Contrast menu.
Geometric distortion	Screen not centered correctly	Reset the monitor to factory settings.
Horizontal/vertical lines	Screen has one or more lines	<ul style="list-style-type: none"> ▪ Reset the monitor to factory settings. ▪ Perform monitor self-test feature check and determine if these lines are also in self-test mode. ▪ Check for bent or broken pins in the video cable connector. ▪ Run the built-in diagnostics.
Synchronization problems	Screen is scrambled or appears torn	<ul style="list-style-type: none"> ▪ Reset the monitor to factory settings. ▪ Perform monitor self-test feature check to determine if the scrambled screen appears in self-test mode. ▪ Check for bent or broken pins in the video cable connector. ▪ Restart the computer in the <i>safe mode</i>.

Common symptoms	What you experience	Possible solutions
Safety related issues	Visible signs of smoke or sparks	<ul style="list-style-type: none"> ▪ Do not perform any troubleshooting steps. ▪ Contact Dell immediately.
Intermittent problems	Monitor malfunctions on and off	<ul style="list-style-type: none"> ▪ Ensure that the video cable connecting the monitor to the computer is connected properly and is secure. ▪ Reset the monitor to factory settings. ▪ Perform monitor self-test feature check to determine if the intermittent problem occurs in self-test mode.
Missing color	Picture missing color	<ul style="list-style-type: none"> ▪ Perform monitor self-test feature check. ▪ Ensure that the video cable connecting the monitor to the computer is connected properly and is secure. ▪ Check for bent or broken pins in the video cable connector.
Wrong color	Picture color not good	<ul style="list-style-type: none"> ▪ Change the settings of the Preset Modes in the Game menu OSD depending on the application. ▪ Adjust Gain/Offset/Hue/Saturation value under Custom Color in the Game menu OSD. ▪ Change the Input Color Format to RGB or YCbCr/YPbPr in the Display settings OSD. ▪ Run the built-in diagnostics.
Wrong color in HDR mode	Color banding in the pictures	Try to lower down the frequency (DP: 3440 x 1440 at 100 Hz, HDMI: 3440 x 1440 at 60 Hz).

Product specific problems

Specific symptoms	What you experience	Possible solutions
Screen image is too small	Image is centered on screen, but does not fill entire viewing area	Reset the monitor to factory settings.
Cannot adjust the monitor with the joystick	OSD does not appear on the screen	<ul style="list-style-type: none">▪ Turn off the monitor, unplug the power cord, plug it back, and then turn on the monitor.▪ Check whether the OSD menu is locked. If yes, move and hold the joystick forward/backward/left/right for 4 seconds to unlock (for more information, see Locking the control buttons).
No input signal when user controls are pressed	No picture, the LED light is blue	<ul style="list-style-type: none">▪ Check the signal source. Ensure that the computer is not in the power saving mode by moving the mouse or pressing any key on the keyboard.▪ Check whether the signal cable is plugged in properly. Re-plug the signal cable if necessary.▪ Reset the computer or video player.
The picture does not fill the entire screen	The picture cannot fill the height or width of the screen	<ul style="list-style-type: none">▪ Due to different video formats (aspect ratio), the monitor may display in full screen.▪ Run the built-in diagnostics.
The displayed pictures appear incorrectly when the DP/HDMI cable is connected through a USB-C adapter or dock to your laptop or desktop	Display will freeze, has black screen or display abnormal screen	Do not use a USB-C adapter or dock. Connect the DP/HDMI cable directly to your laptop or desktop.

Specific symptoms	What you experience	Possible solutions
Screen flickering	There are some noticeable flickering in the displayed pictures	<ul style="list-style-type: none"> ▪ Use the native resolution of your monitor (3440 x 1440 at 60 Hz) or higher refresh rate. ▪ If the variable refresh rate (VRR) of your device is turned on, turn off variable refresh rate (VRR). ▪ If you are using an NVIDIA graphics card and G-Sync is turned on, turn off G-Sync. ▪ If you are using an AMD graphics card and Free-Sync is turned on, turn off Free-Sync. ▪ Update the graphics card driver and firmware to the latest version. ▪ Change the cable connecting the monitor to the computer. A defective cable can cause the signal to break while being transmitted across the wire. ▪ Check the surroundings. Electromagnetic fields can cause screen flickering. If there is another device plugged into the same power strip as the monitor, try to remove it.
Image retention from a static image left on the monitor for a long period of time	Faint shadow from the static image displayed appears on the screen	<ul style="list-style-type: none"> ▪ Set the screen to turn off after a few minutes of screen idle time. These can be adjusted in Windows Power Options or Mac Energy Saver setting.
Unevenness in luminance or color of the screen images	Visible spots (bright or dark) or lines or Mura appear on the screen	<ul style="list-style-type: none"> ▪ Alternatively, use a dynamically changing screensaver. ▪ Perform the function of Pixel Refresh or Panel Refresh. For more information, see OLED Panel Maintenance.

Specific symptoms	What you experience	Possible solutions
<p>In the HDR Peak 1000 mode, the displayed images are dimmer than they are in the DisplayHDR True Black mode</p>	<p>The HDR Peak 1000 mode is ideal for the HDR content with a peak brightness of 1000 nits. When displaying non-HDR content, such as browsers and editors, the brightness level in the HDR Peak 1000 mode is observed to be lower as compared to that in the DisplayHDR True Black mode due to the luminance control method of OLED panels.</p>	<ul style="list-style-type: none"> ▪ For displaying non-HDR content, such as Office applications, disable the HDR display feature in Windows display settings. ▪ For displaying HDR videos or games with a maximum peak brightness of 1000 nits, set Smart HDR to HDR Peak 1000. ▪ For displaying HDR videos or games which meet the DisplayHDR 400 True Black standard, set Smart HDR to DisplayHDR True Black.
<p>Pixel shifting occurs</p>	<p>The image on the screen moves slightly sometimes.</p>	<p>Pixel shift is a function that moves the pixels of the screen to prevent image retention on QD-OLED panels. It does not influence your viewing experience.</p>

Universal Serial Bus (USB) specific problems

Specific symptoms	What you experience	Possible solutions
USB interface is not working	USB peripherals are not working	<ul style="list-style-type: none">▪ Check that your monitor is turned on.▪ Reconnect the upstream cable to your computer.▪ Reconnect the USB peripherals (downstream connector).▪ Turn off and then turn on the monitor again.▪ Reboot your computer.▪ Some USB devices like external portable HDD require higher electric current; connect the device directly to the computer system.
SuperSpeed USB 5 Gbps (USB 3.2 Gen 1) interface is slow	SuperSpeed USB 5 Gbps (USB 3.2 Gen 1) peripherals working slowly or not working at all	<ul style="list-style-type: none">▪ Check that your computer is SuperSpeed USB 5 Gbps (USB 3.2 Gen 1)-compatible.▪ Some computers have USB 3.2, USB 2.0, and USB 1.1 ports. Ensure that the correct USB port is used.▪ Reconnect the upstream cable to your computer.▪ Reconnect the USB peripherals (downstream connector).▪ Reboot your computer.
Wireless USB peripherals stop working when a USB 3.2 device is plugged in	Wireless USB peripherals responding slowly or only working as the distance between itself and its receiver decreases	<ul style="list-style-type: none">▪ Increase the distance between the USB 3.2 peripherals and the wireless USB receiver.▪ Position your wireless USB receiver as close as possible to the wireless USB peripherals.▪ Use a USB-extender cable to position the wireless USB receiver as far away as possible from the USB 3.2 port.

Regulatory information

FCC notices (U.S. only) and other regulatory information



For FCC notices and other regulatory information, see the regulatory compliance website located at www.dell.com/regulatory_compliance.

EU product database for energy label and product information sheet

AW3423DWF: <https://eprel.ec.europa.eu/qr/1337447>

Contacting Dell

To contact Dell for sales, technical support, or customer service issues, see www.dell.com/contactdell.

-  **NOTE: Availability varies by country and product, and some services may not be available in your country.**
-  **NOTE: If you do not have an active internet connection, you can find contact information on your purchase invoice, packing slip, bill, or Dell product catalog.**