



# Harry Potter

76442



LEGO® Builder



### **Get excited about our new packaging!**

We're switching from plastic to paper-based packaging. That's why you might find a mix of paper and plastic in our boxes!

### **Nos nouveaux emballages vous emballeront !**

Nous passons des emballages en plastique aux emballages à base de papier. C'est pourquoi vous pourriez trouver un mélange de papier et de plastique dans nos boîtes !

### **¡Te presentamos nuestros nuevos empaques!**

Estamos sustituyendo las bolsas de plástico por bolsas con base de papel. ¡Por eso, puedes encontrar una mezcla de papel y de plástico en nuestras cajas!

**[LEGO.com/sustainable-packaging](https://www.lego.com/sustainable-packaging)**



Q LEGO® Builder

# BUILDER



Apple and the Apple logo are trademarks of Apple Inc., registered in the U.S. and other countries and regions. App Store is a service mark of Apple Inc. Google Play and the Google Play logo are trademarks of Google LLC. Tencent and the Tencent logo are trademarks of Tencent Inc.

EN Ask parents' permission before going online | DE Eltern um Erlaubnis bitten, bevor du online gehst | FR Demande l'autorisation d'un parent avant d'aller en ligne | IT Chiedi il permesso ai tuoi genitori prima di andare online | ES Pídeles permiso a tus papás antes de conectarte a Internet | PT Pede autorização aos pais antes de acederes online | ZH 上网前应先征得父母的同意 | PL Poproś rodziców o zgodę, zanim wejdiesz do Internetu | CS Než půjdeš na internet, požádej rodiče o svolení | SK Skôr než pôjdeš na internet, vypýtaj si povolenie od rodičov | HU Kérj szülői engedélyt, mielőtt online csatlakoznál! | RO Cere permisiunea părinților înainte de a te conecta online | BG Поискайте разрешение от родител, преди да влезете онлайн | LV Pirms došanās tiešsaistē palūdz atļauju vecākiem | ET Enne Interneti kasutamist küsi vanematelt luba | LT Prieš prisijungdami prie interneto, atsiklauskite tėvų

Q [LEGO.com/devicecheck](https://www.lego.com/devicecheck)

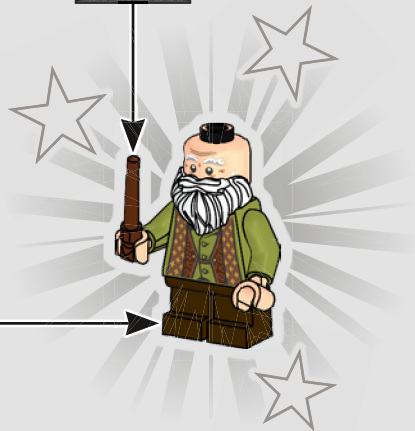
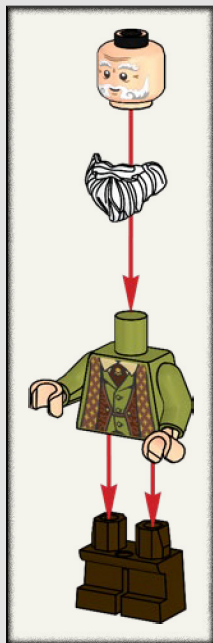

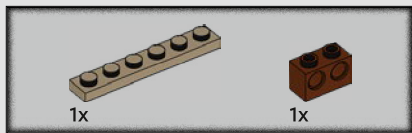

1

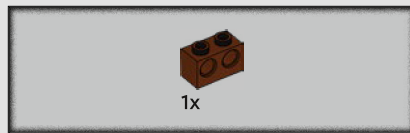
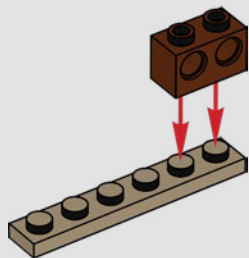

2

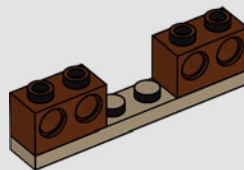

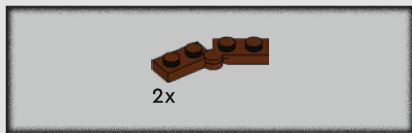

3

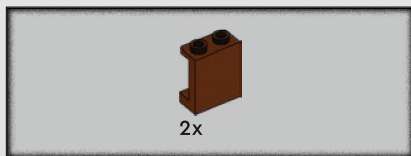
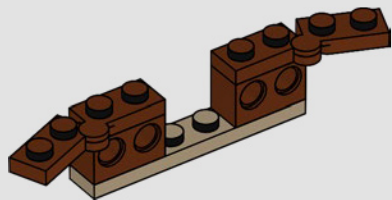

4

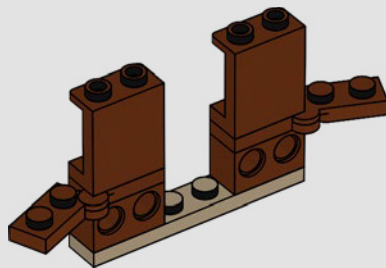

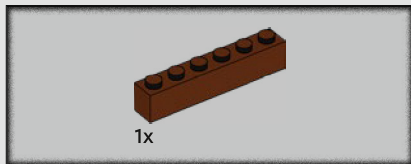
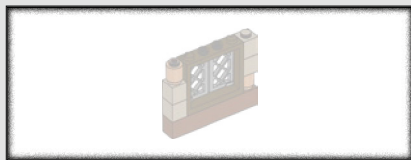

5

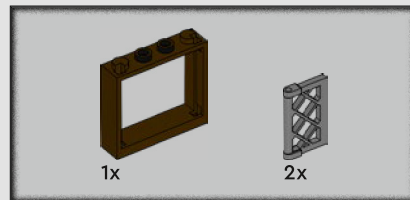
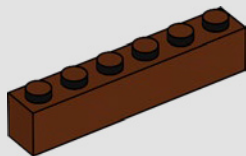

6

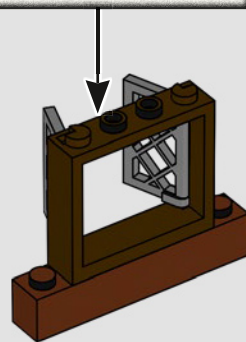
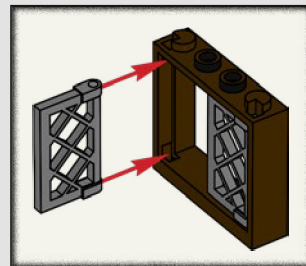

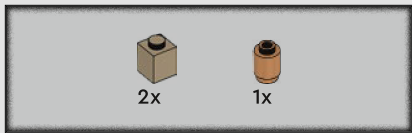

7

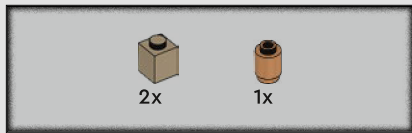
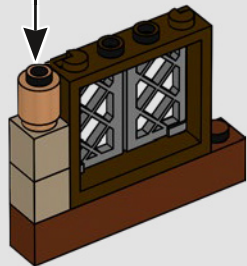
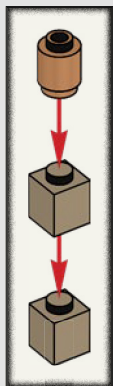

8

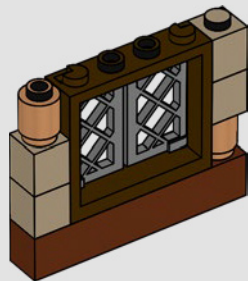
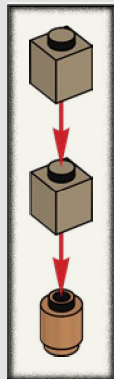



9

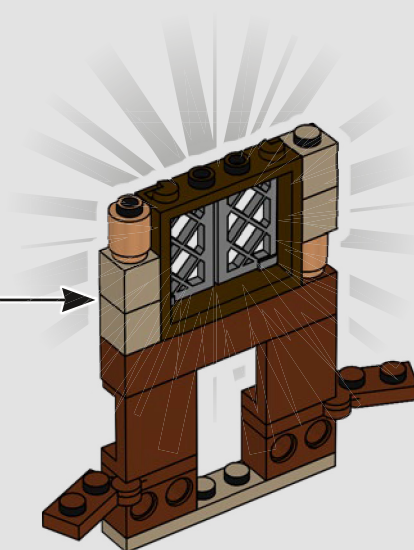

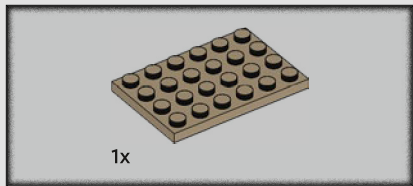

10

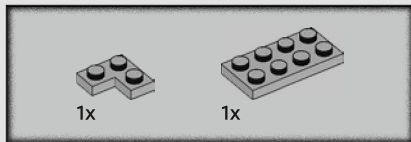
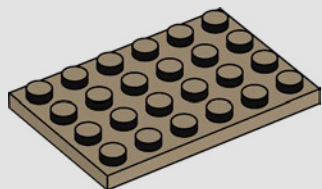

11

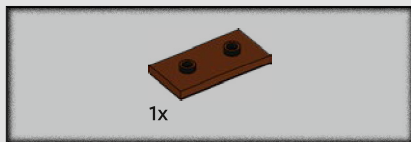
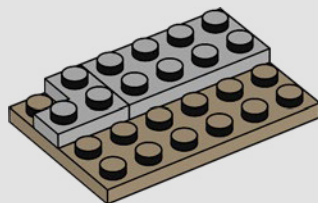

12

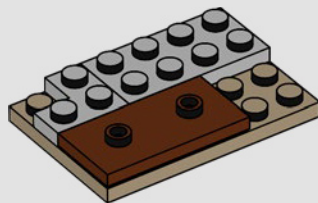

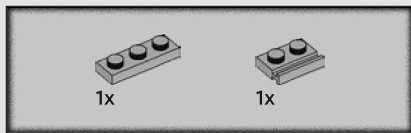

13

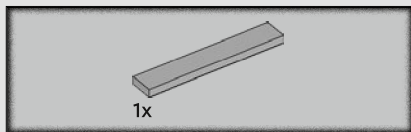
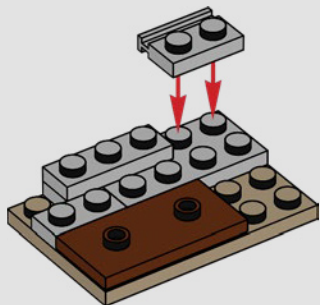

14

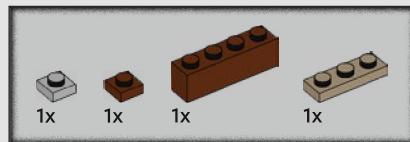
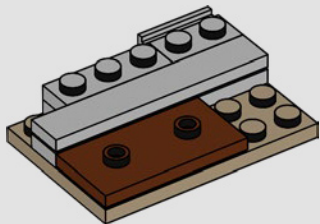

15

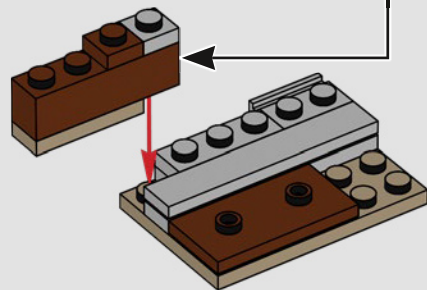
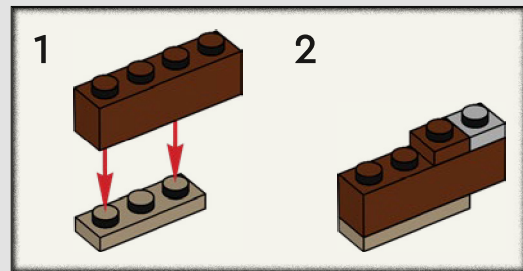

16

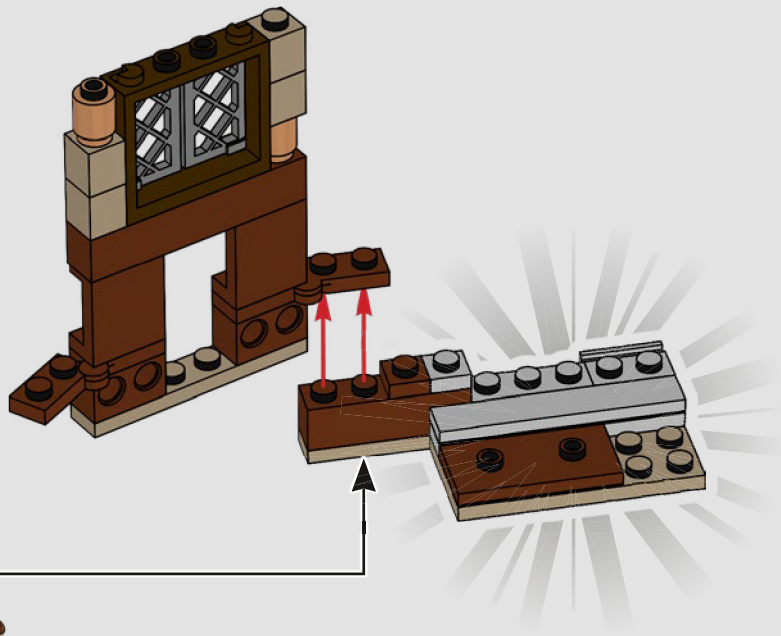

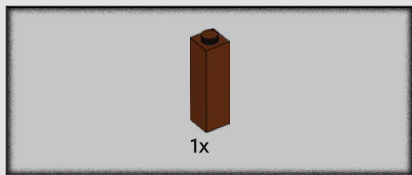

17

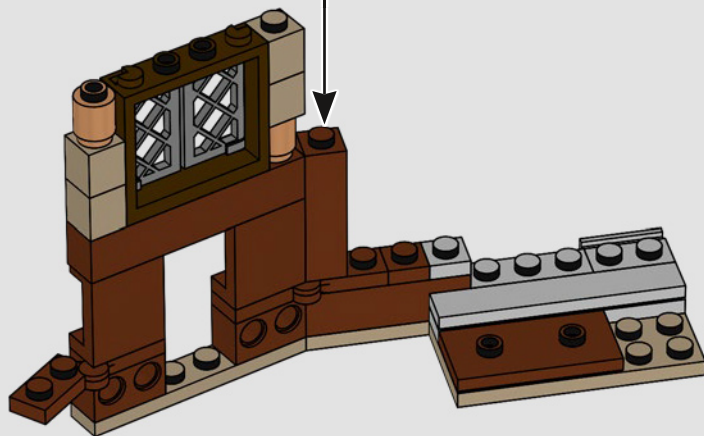
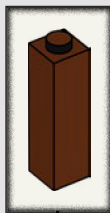

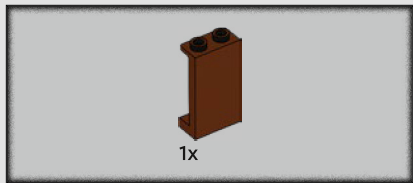

18

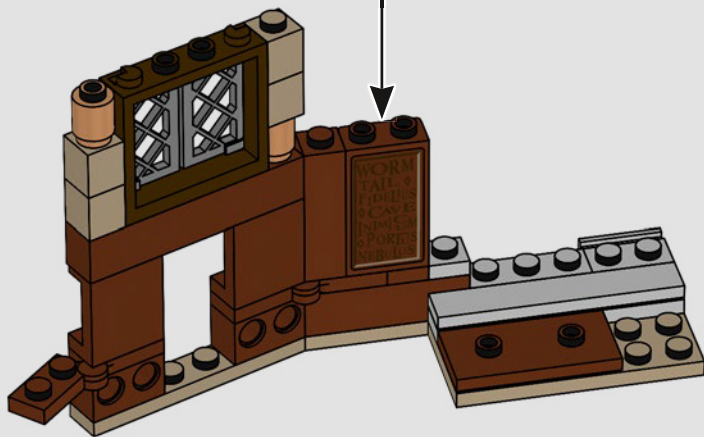
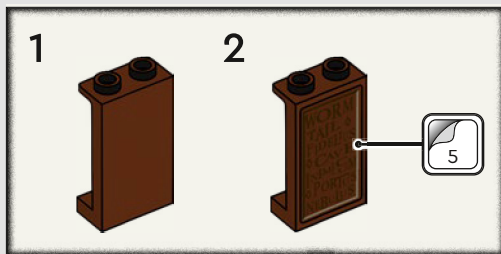

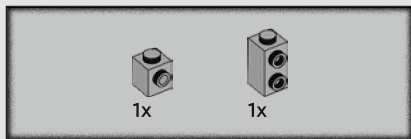

19

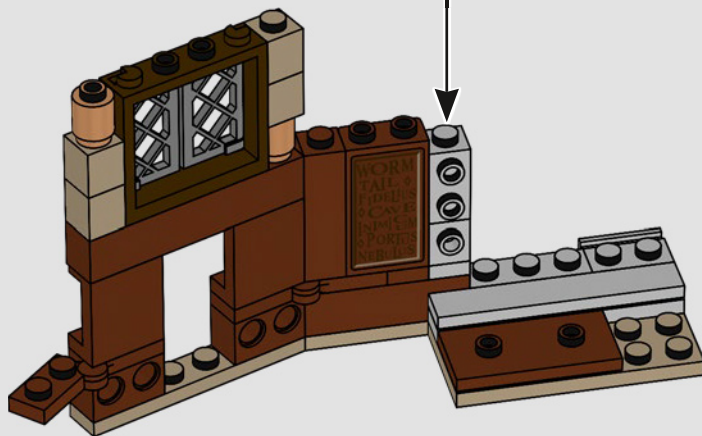
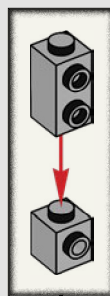

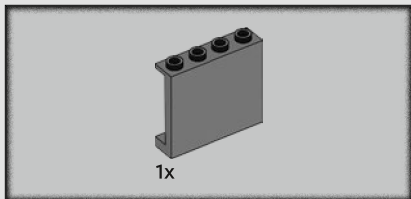

20

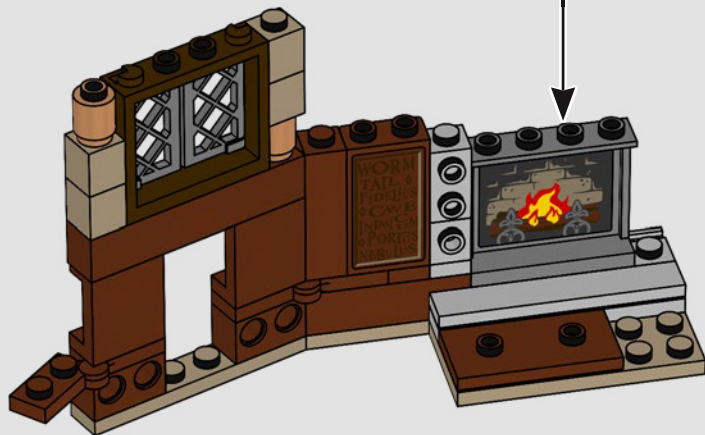
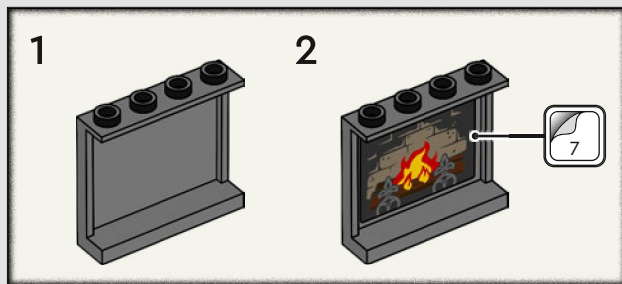



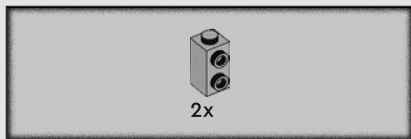

21

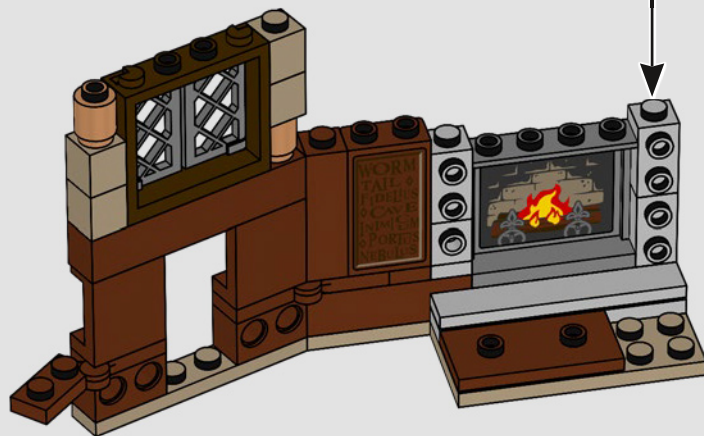
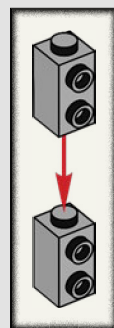

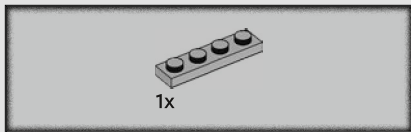

22

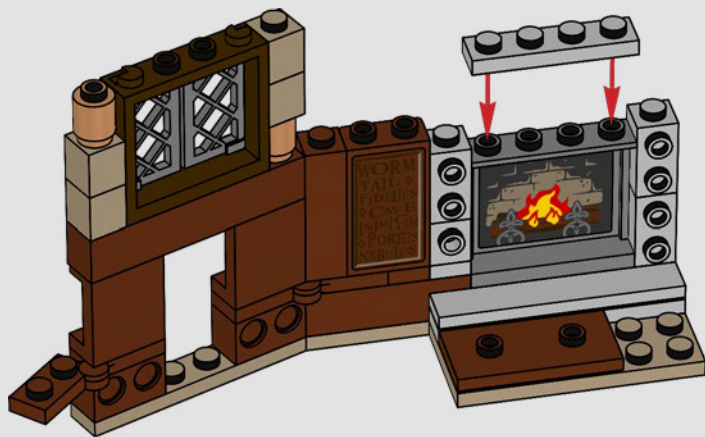

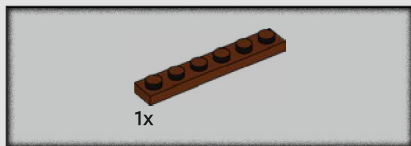

23

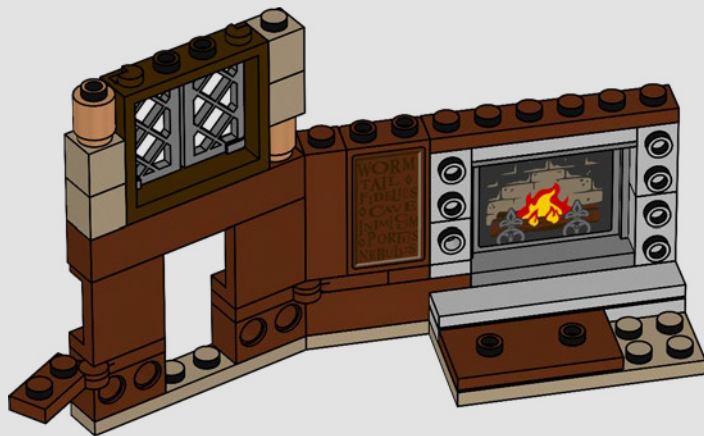



2x

24

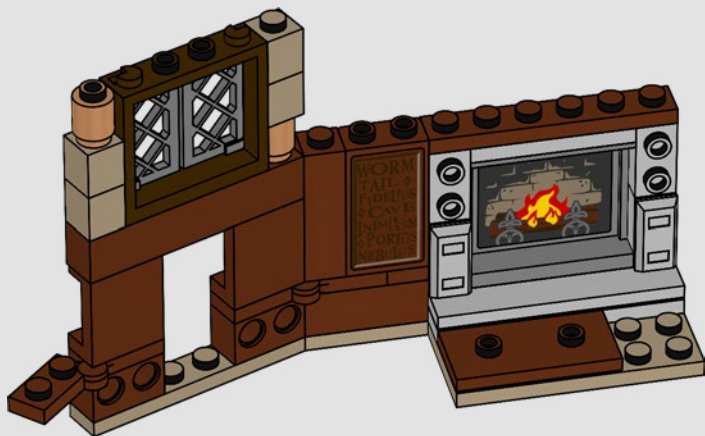

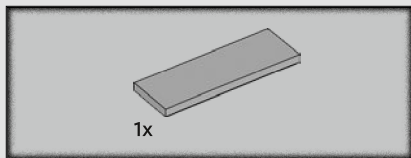

25

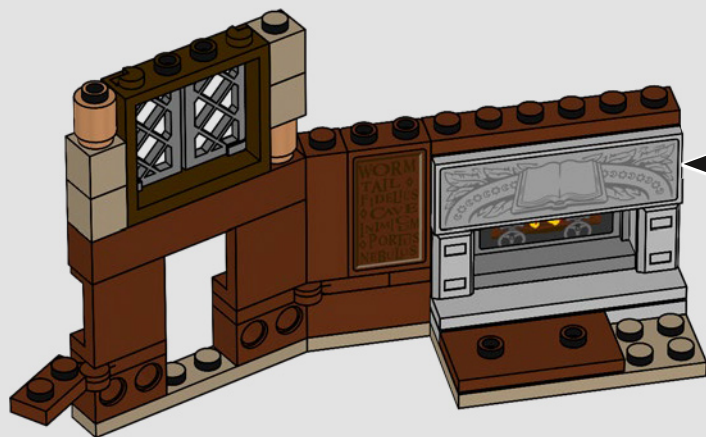
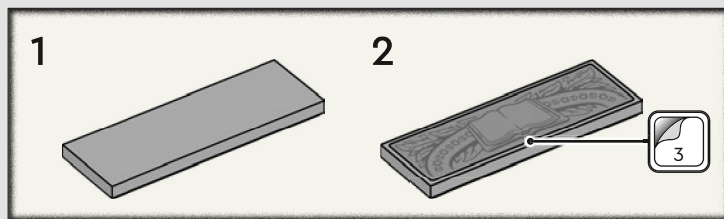

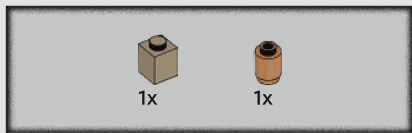

26

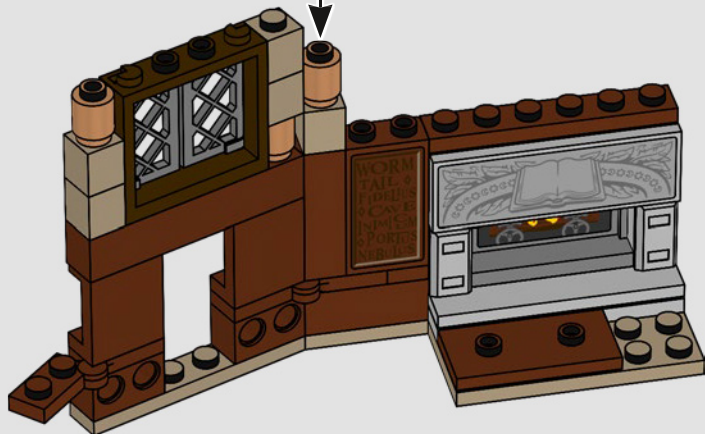
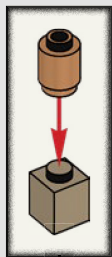

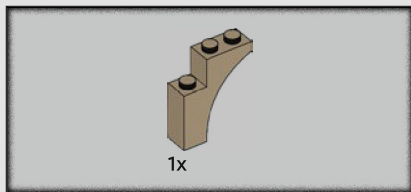

27

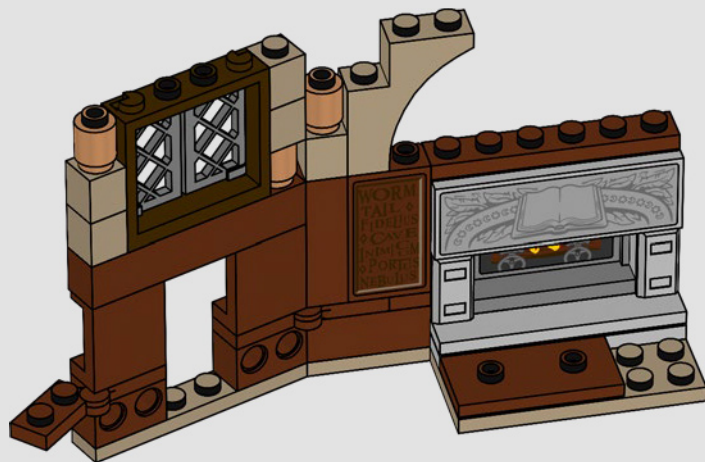

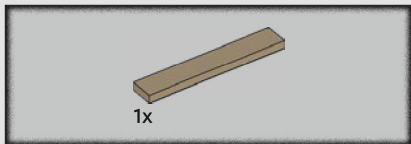

28

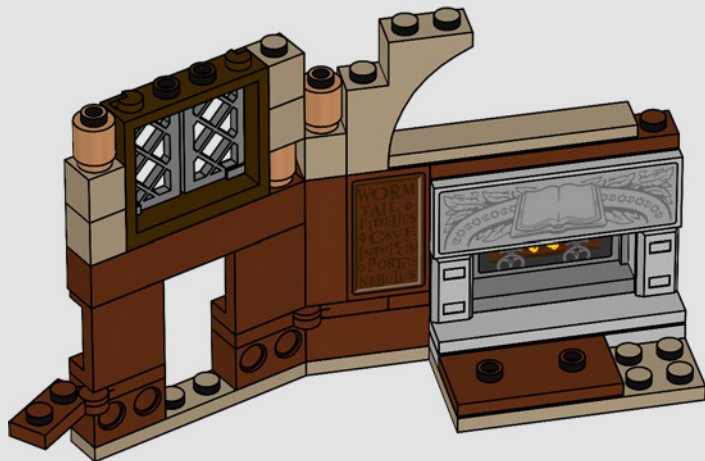



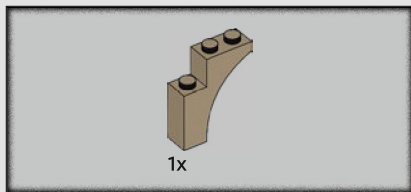

29

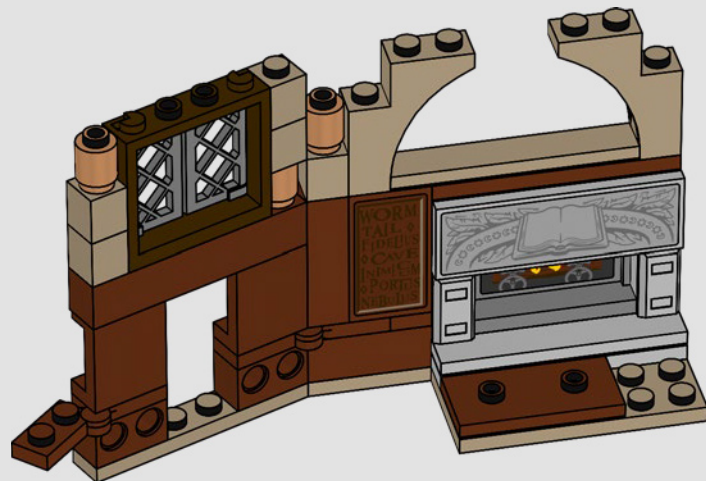

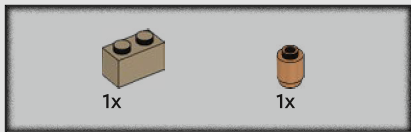

30

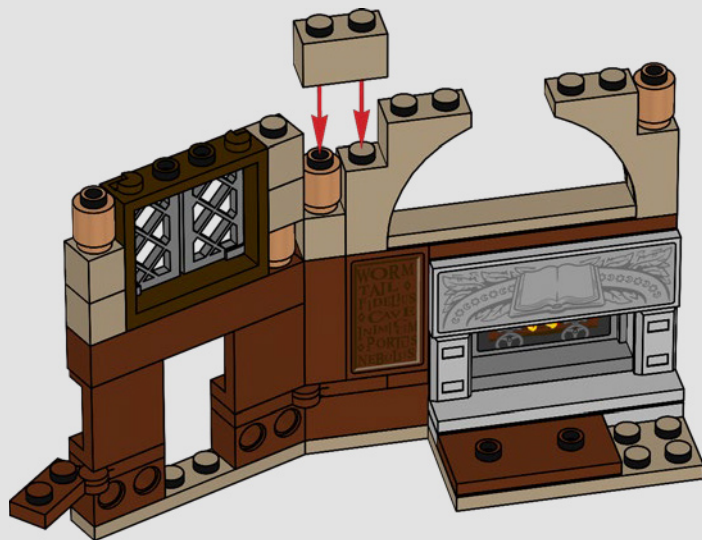

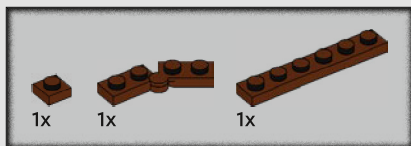

31

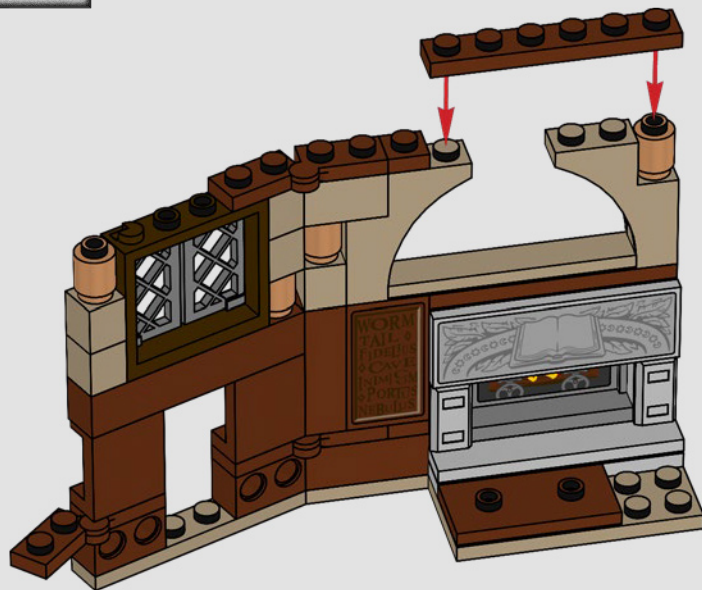

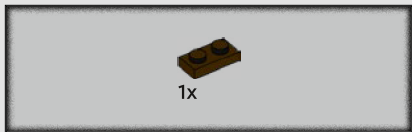

32

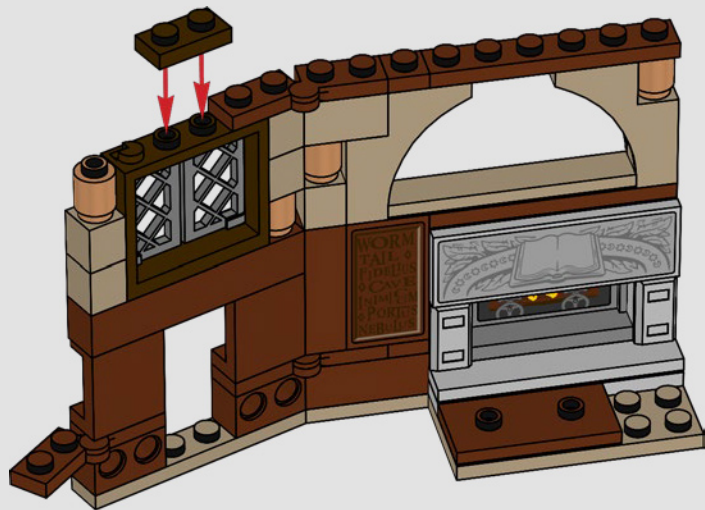

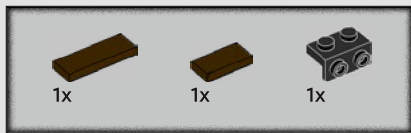

33

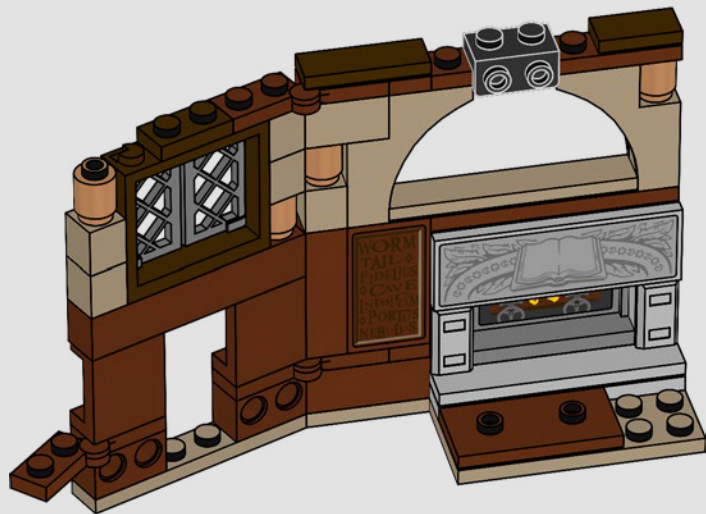



34

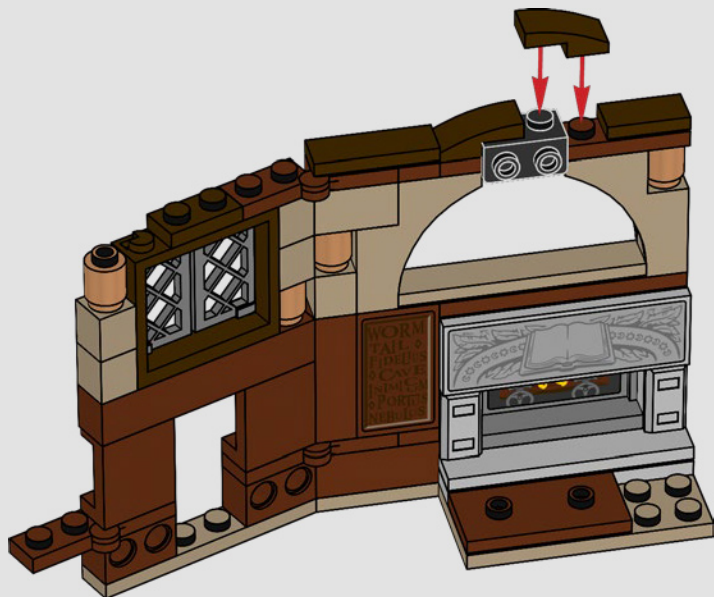

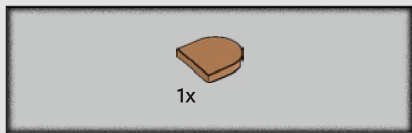

35

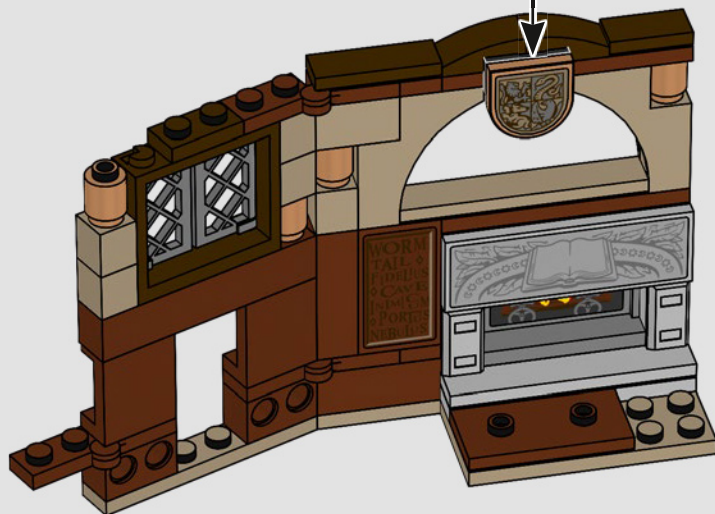
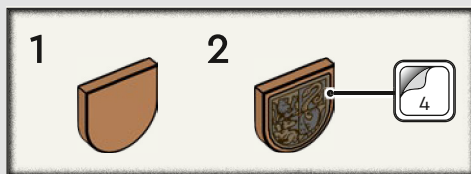

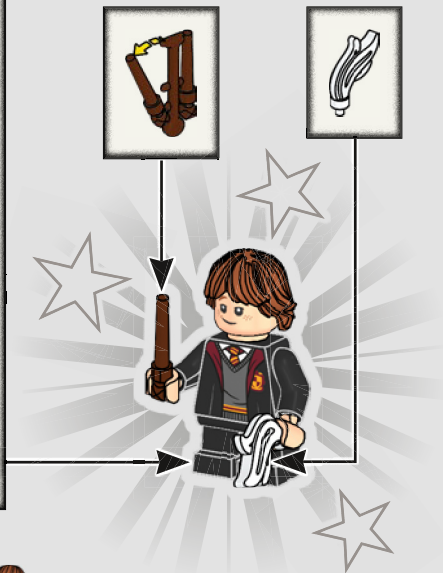
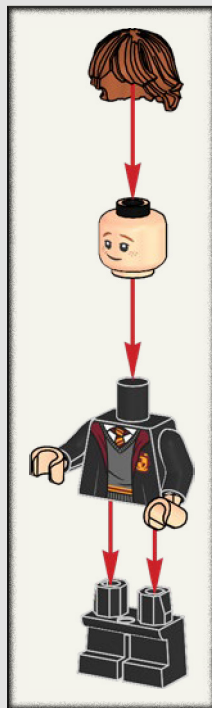



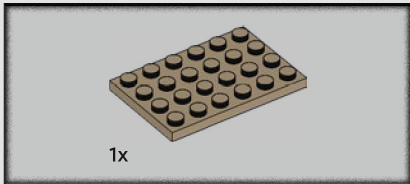
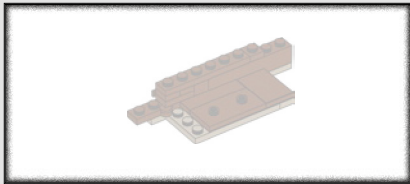

36

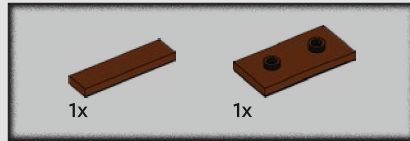
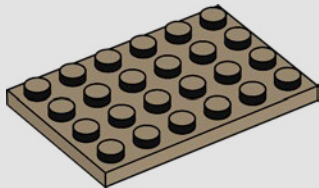

37

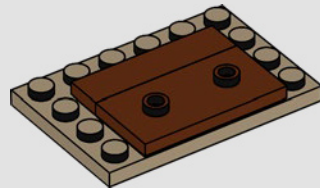

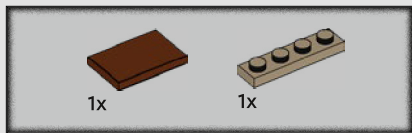

38

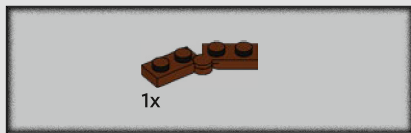
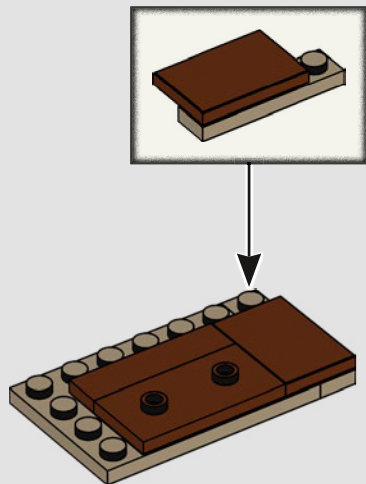

39

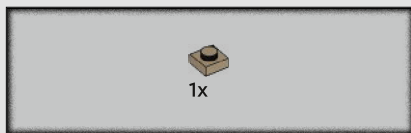
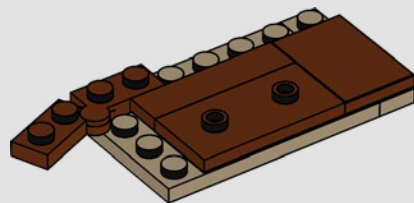

40

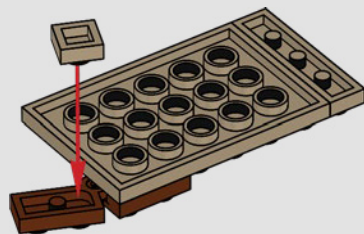

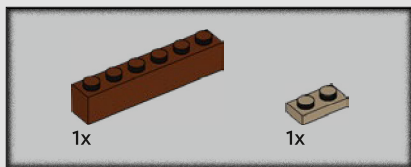

41

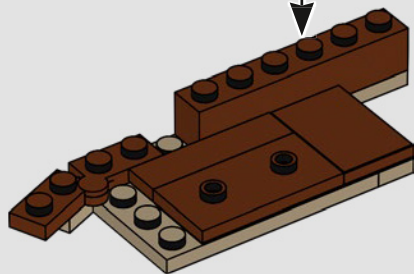
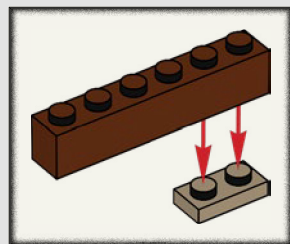

42

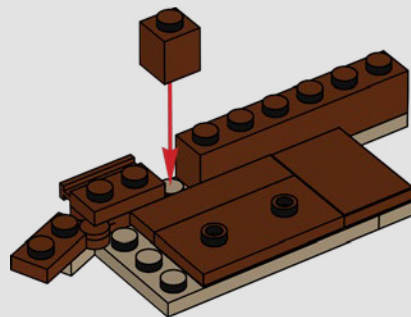



43

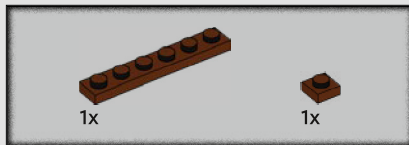
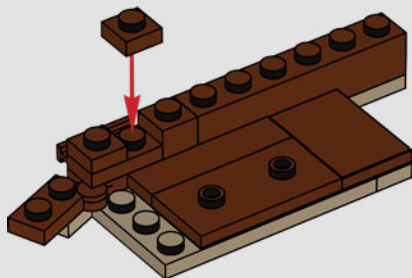

44

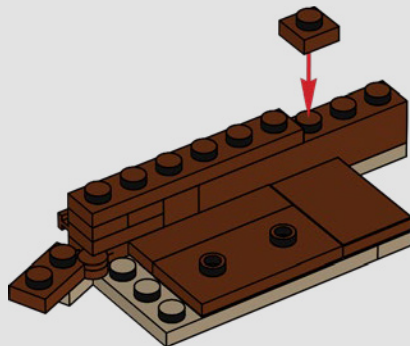

45

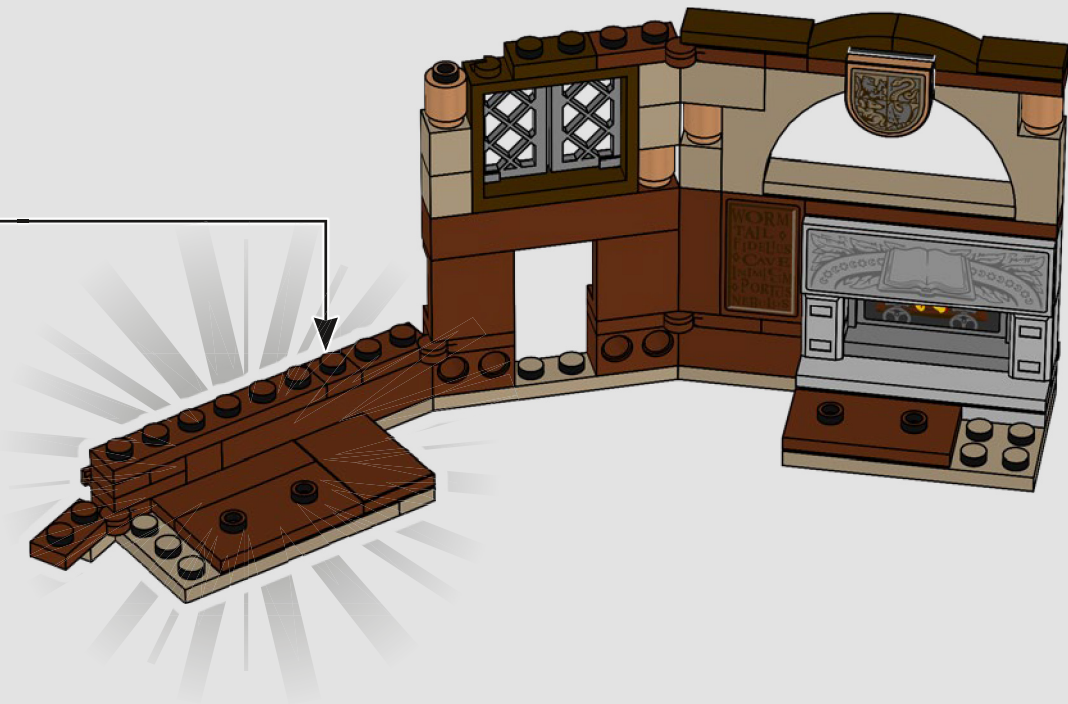

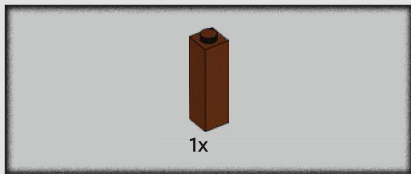

46

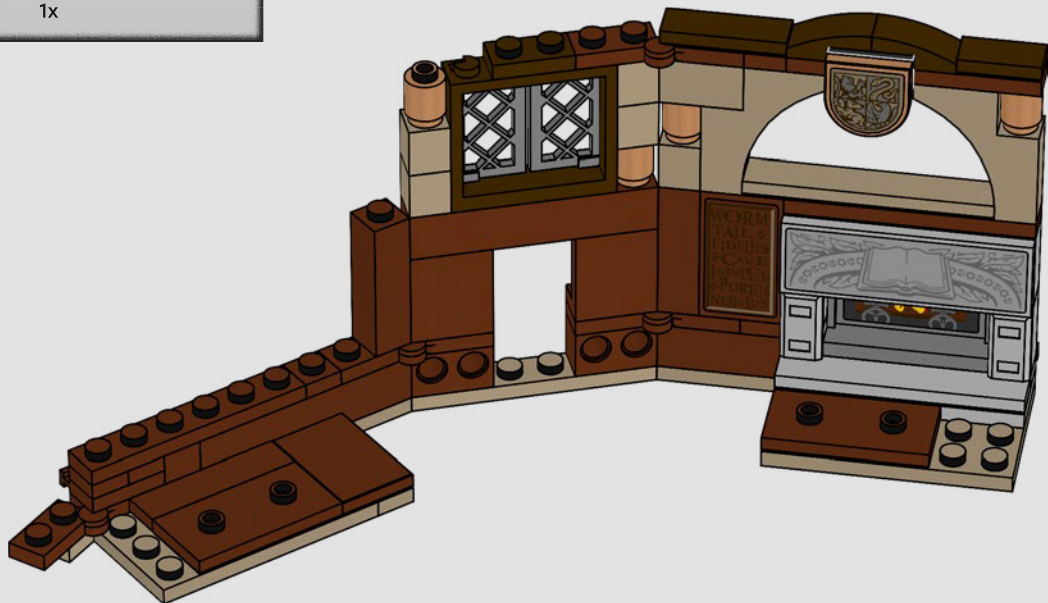

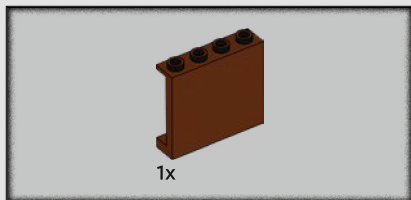

47

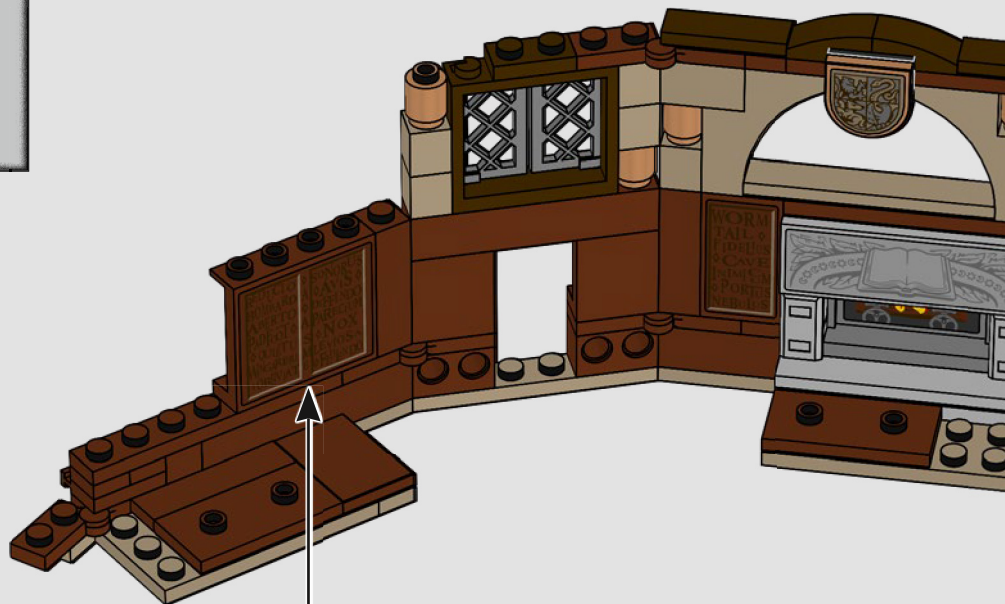
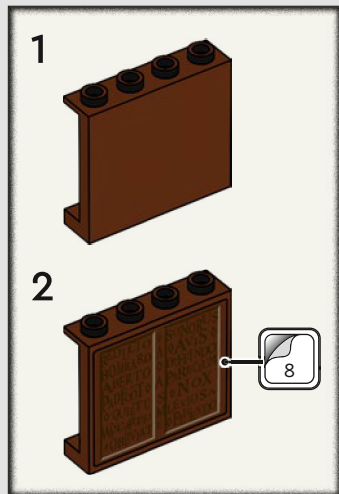

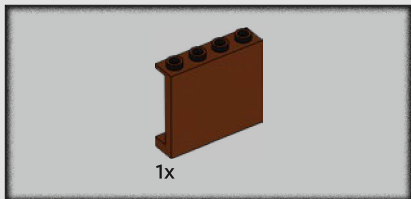

48

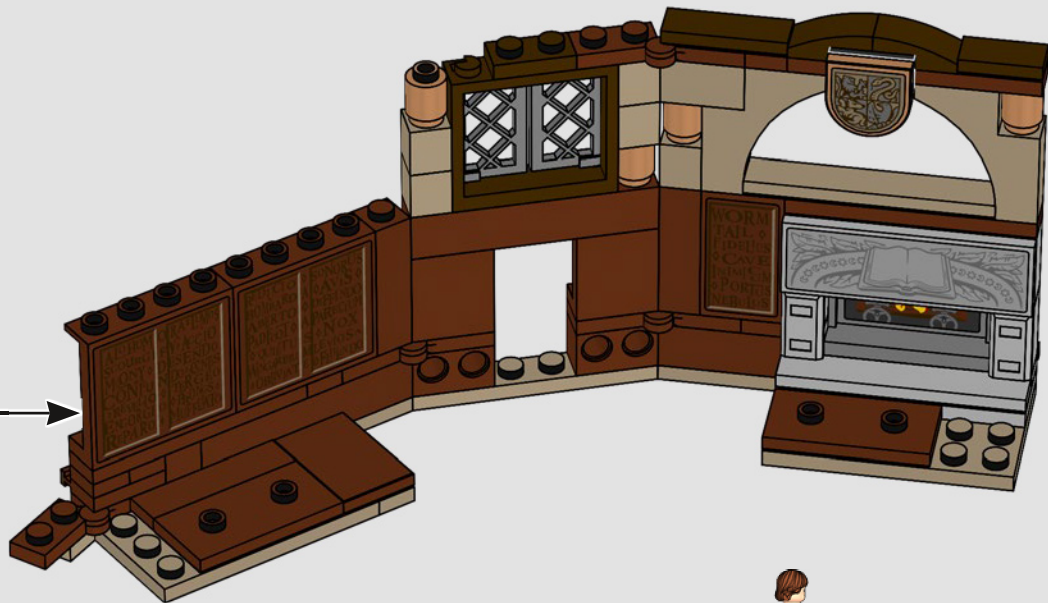
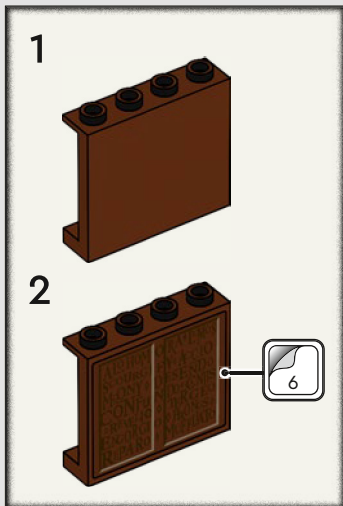



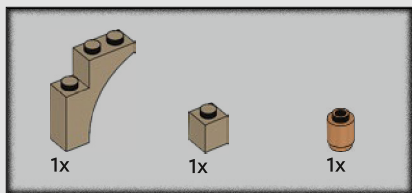

49

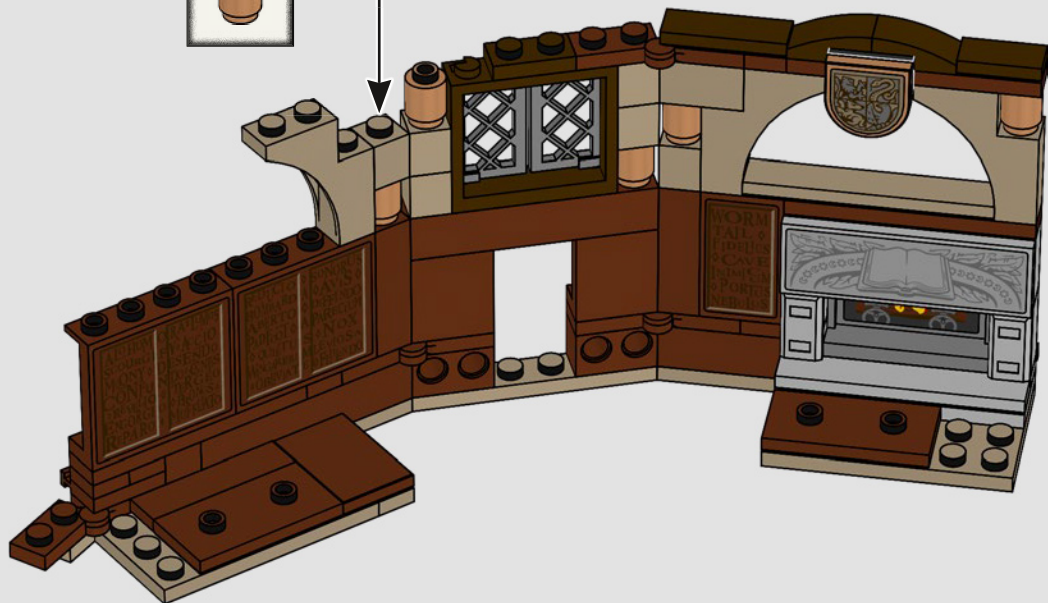
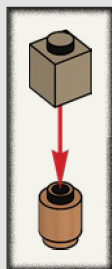

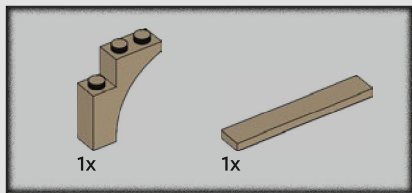

50

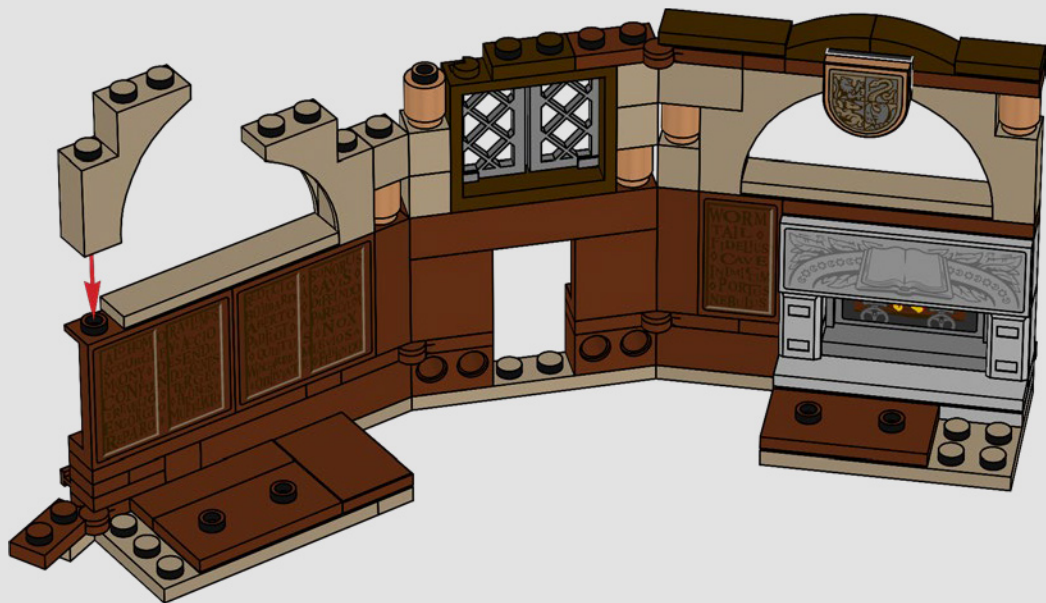

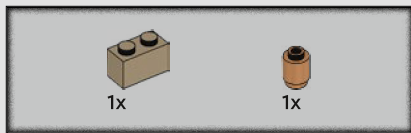

51

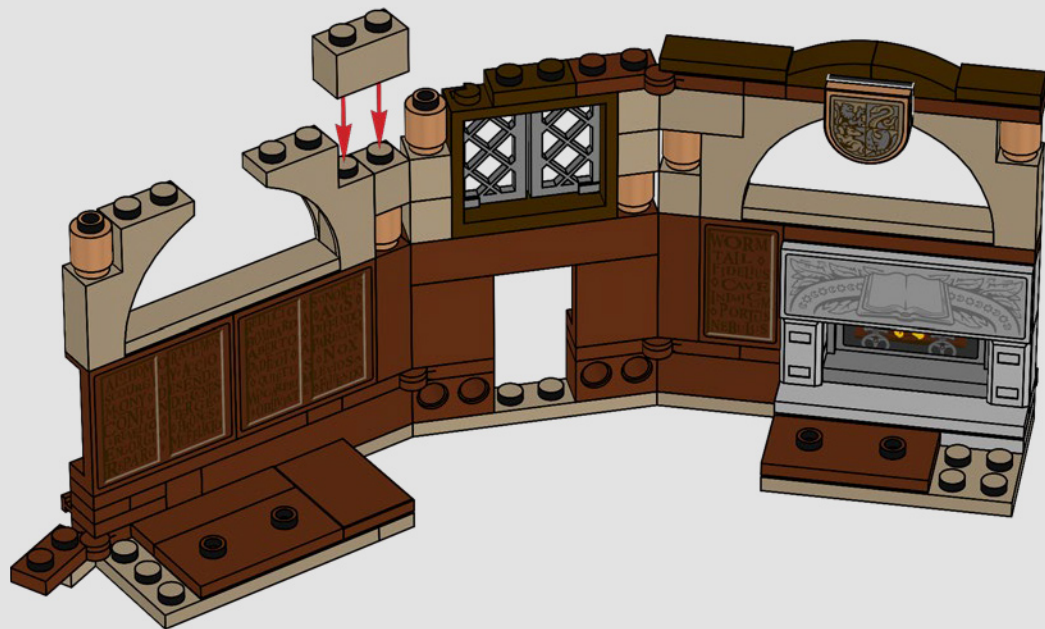

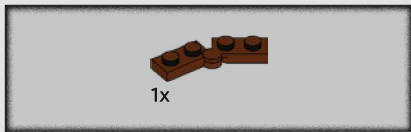

52

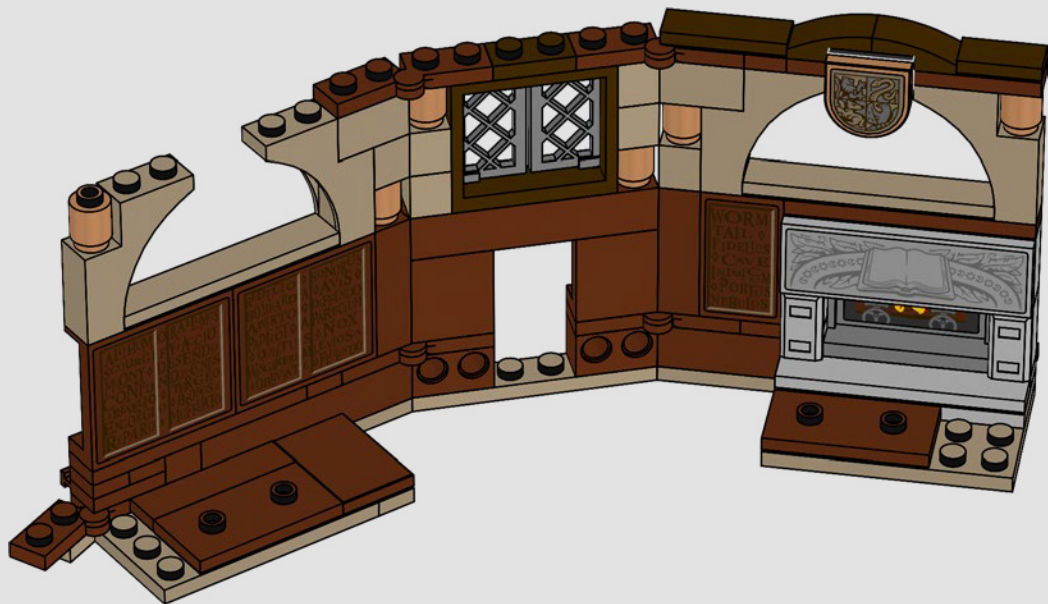

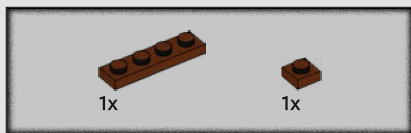

53

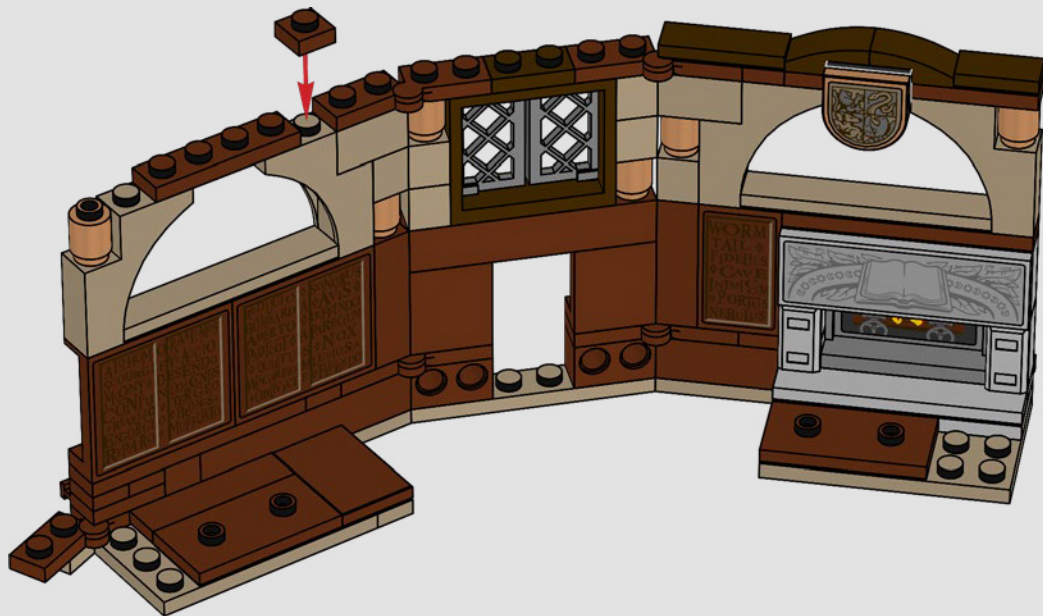

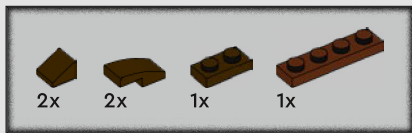

54

1

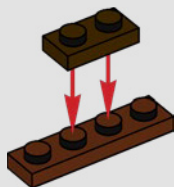

2

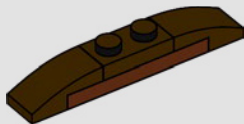

3

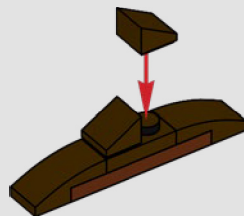

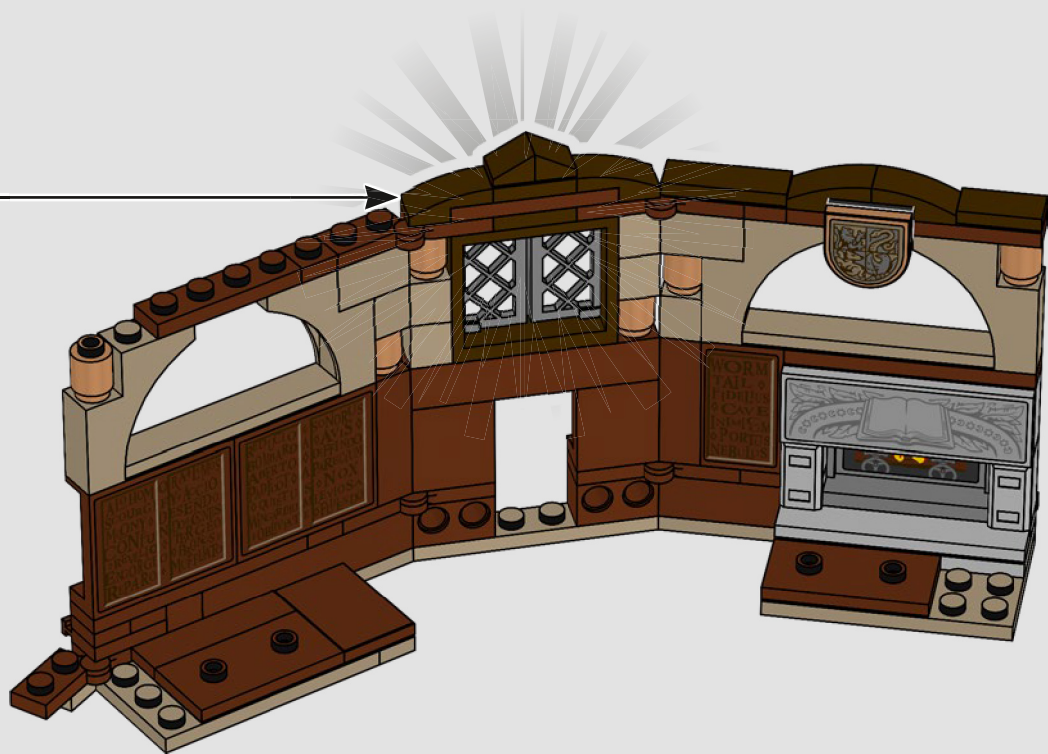



1x

55

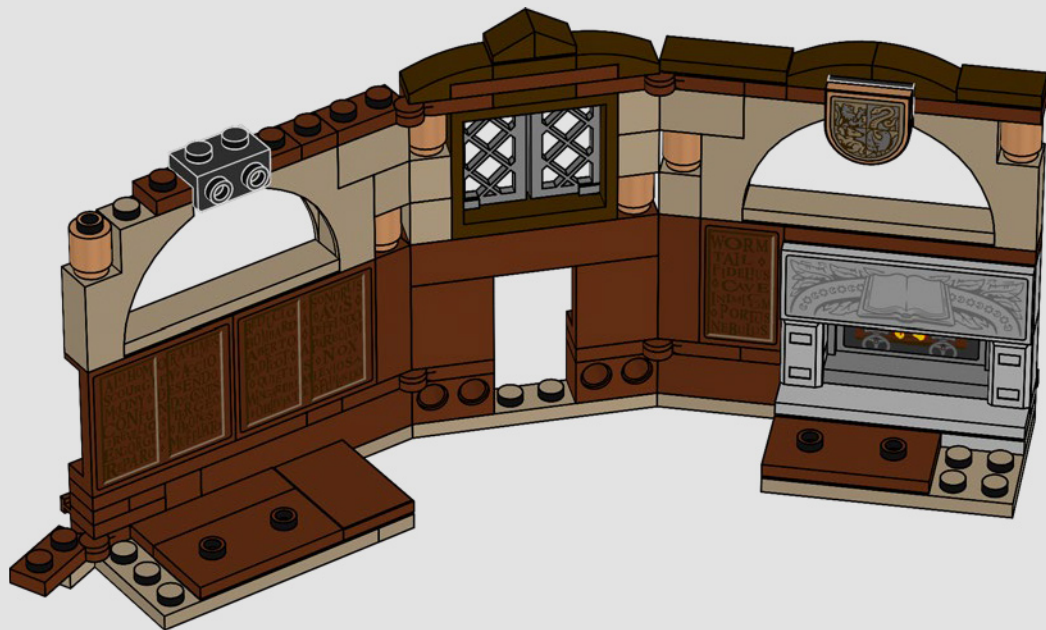





56

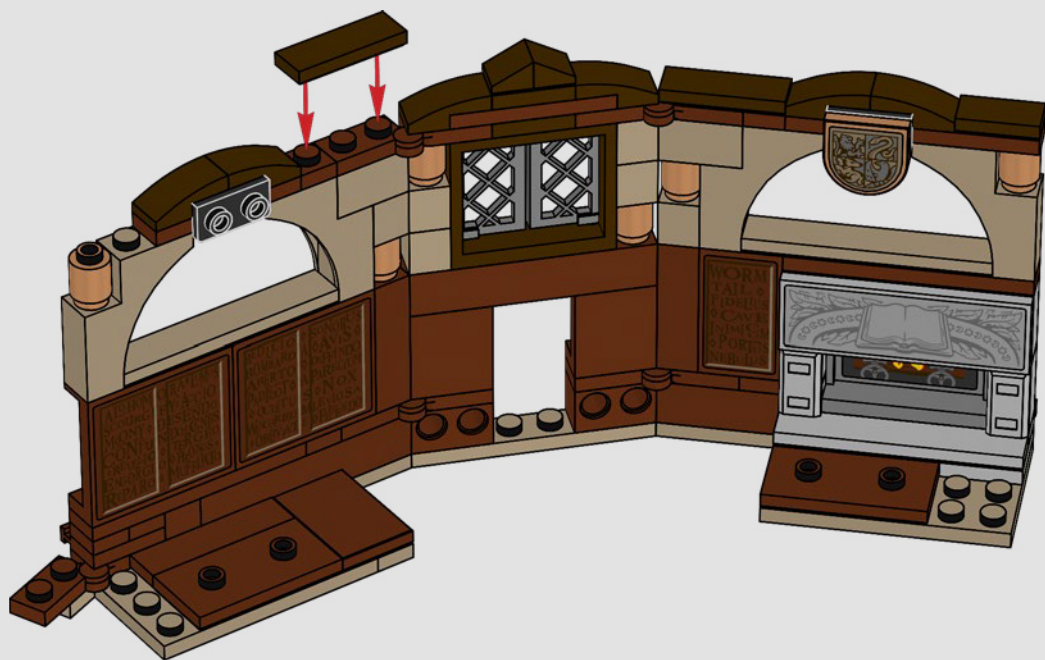

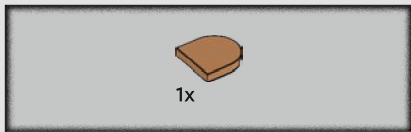

57

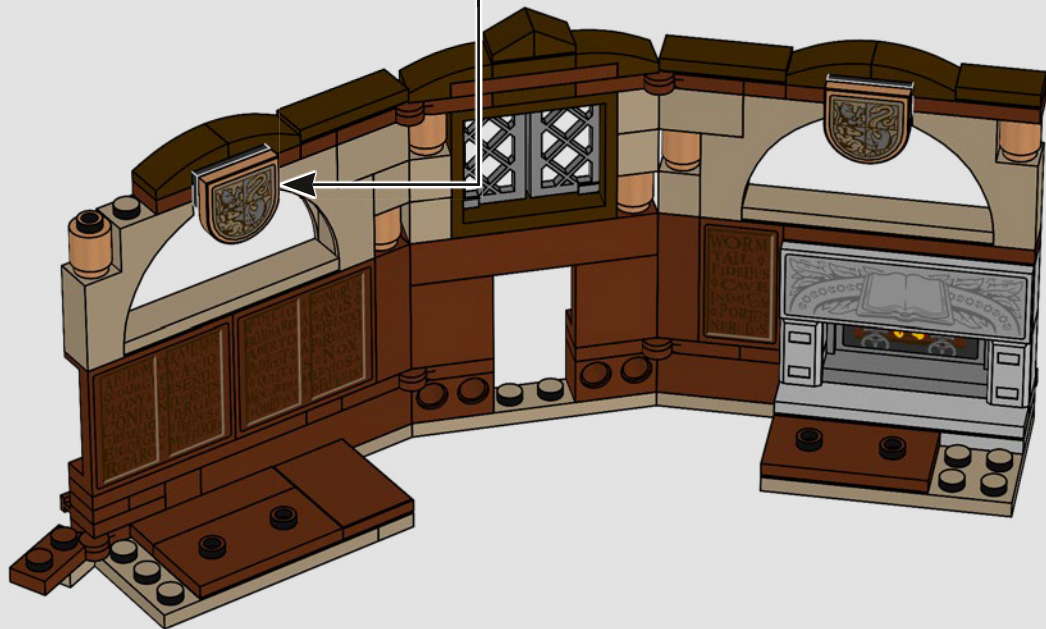
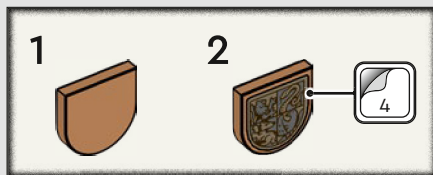

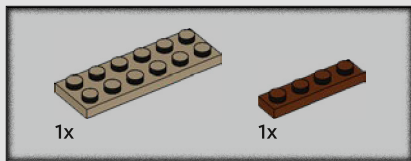

58

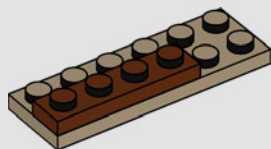

59

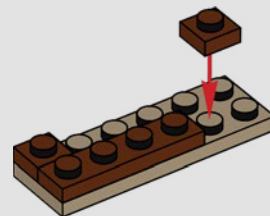

60

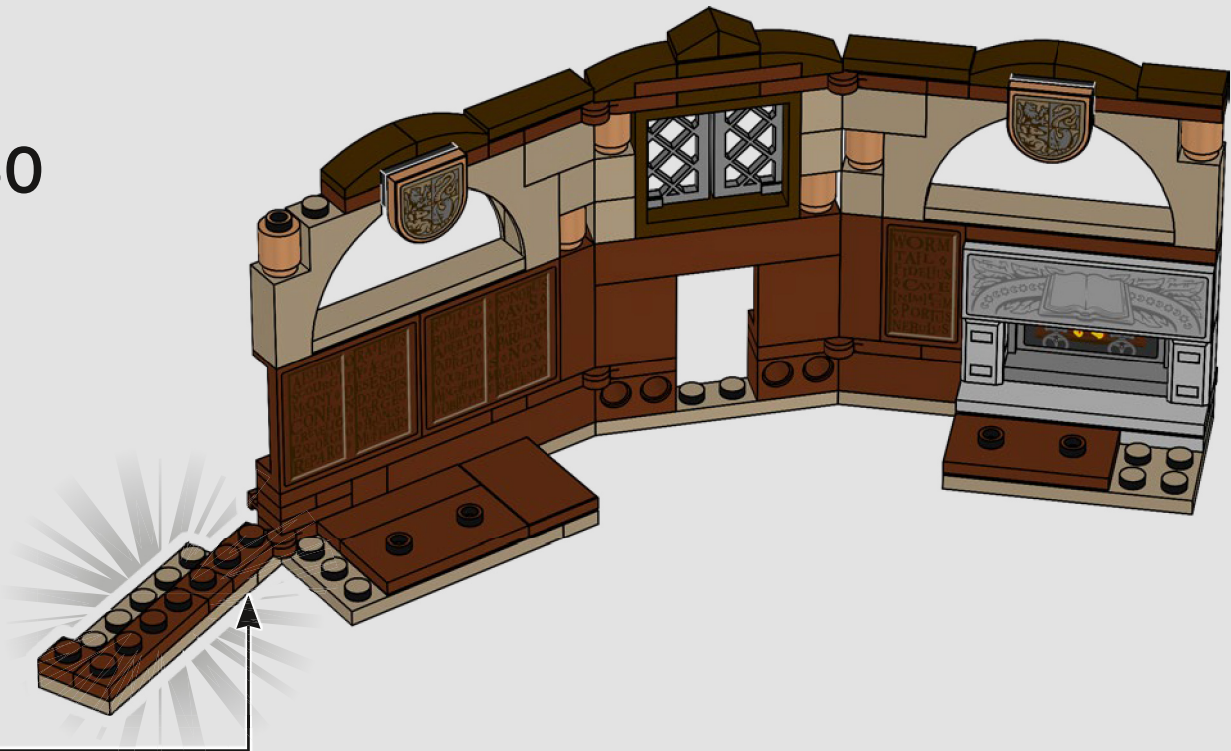

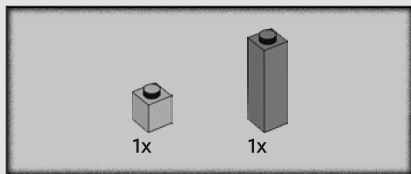

61

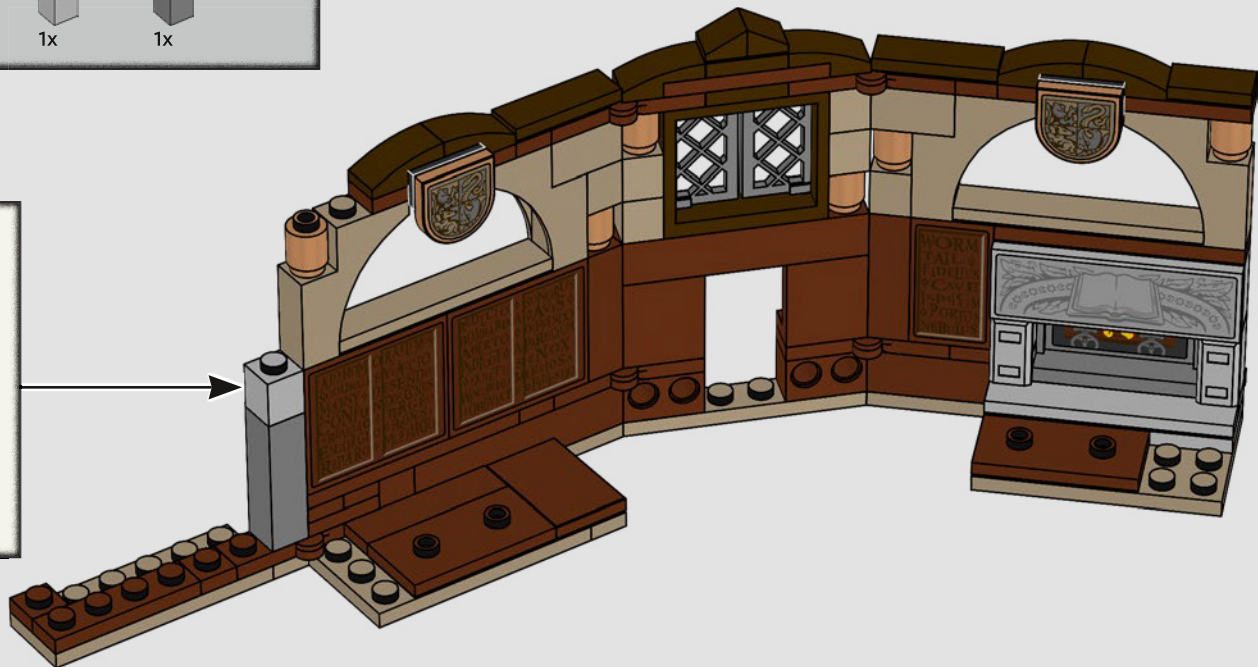
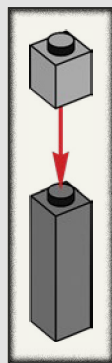

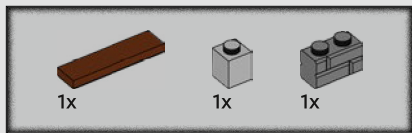

62

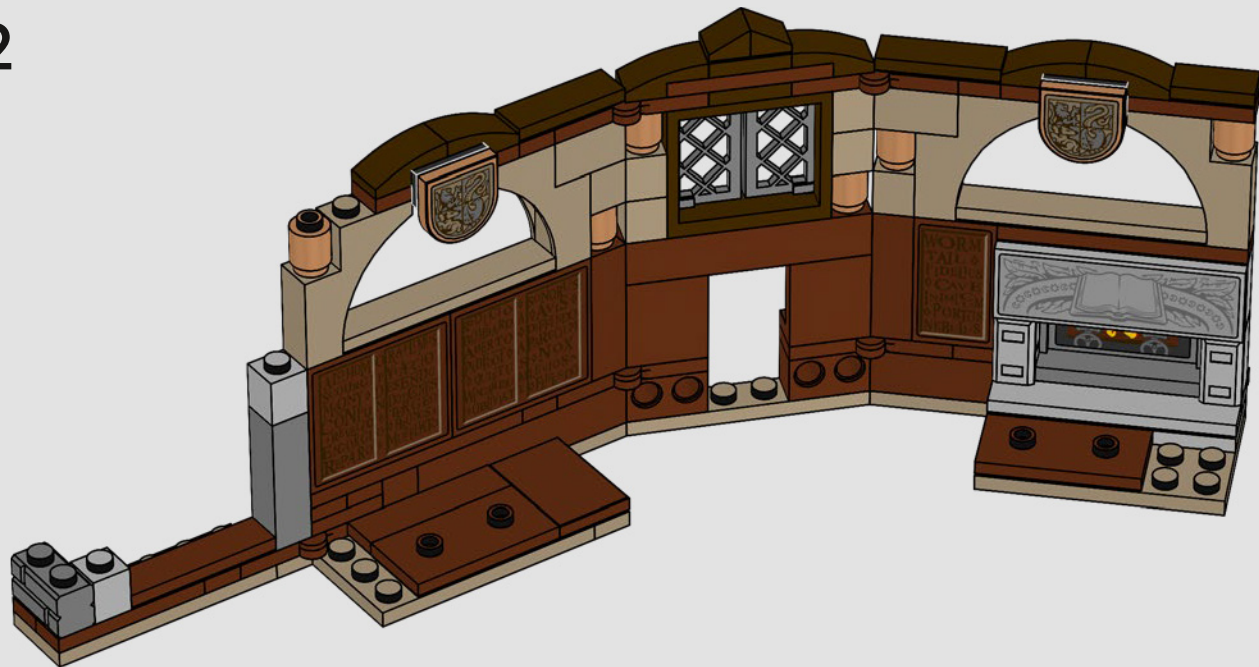

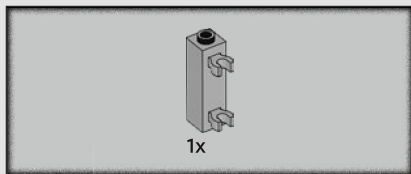

63

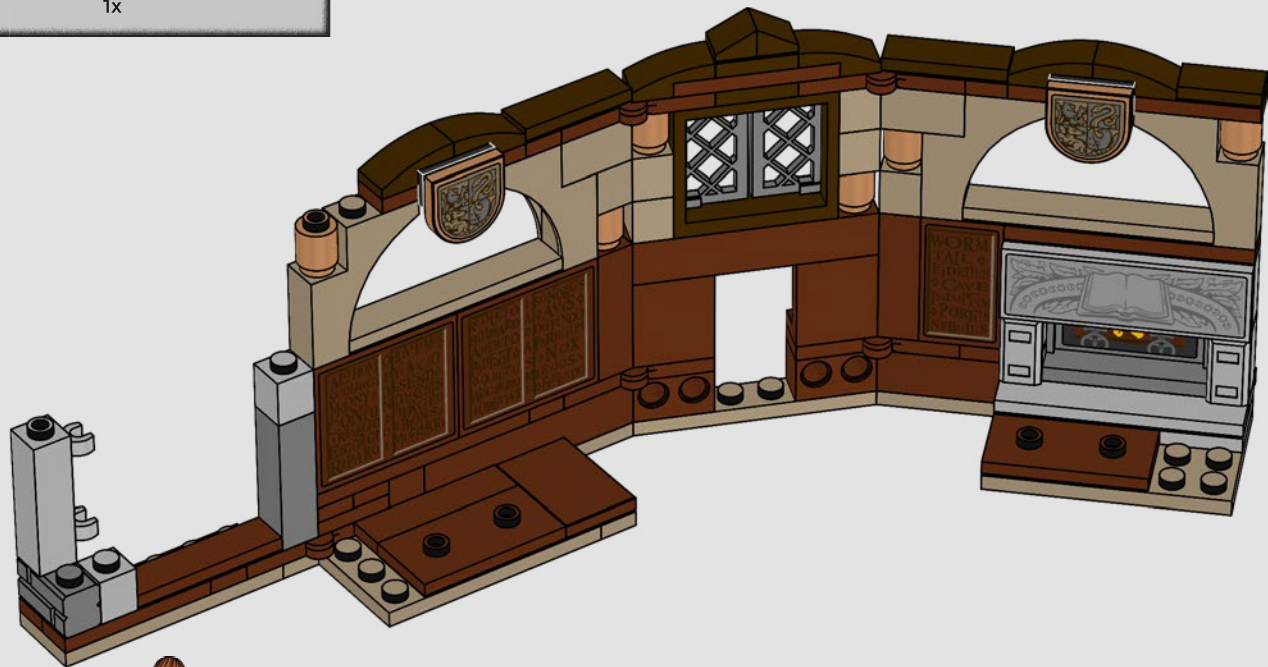

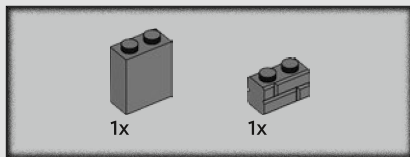

64

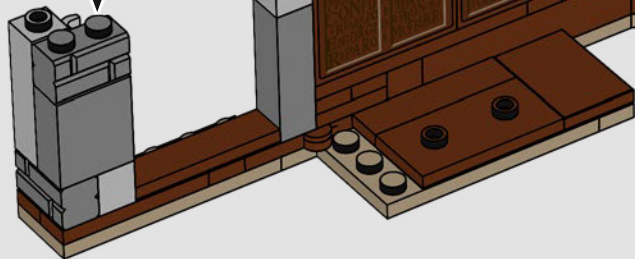
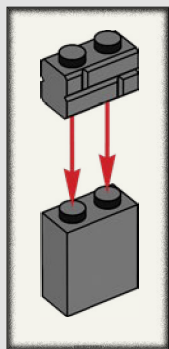



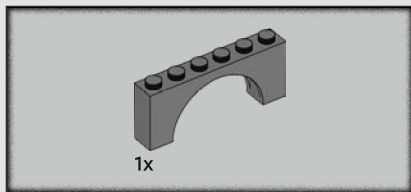

65

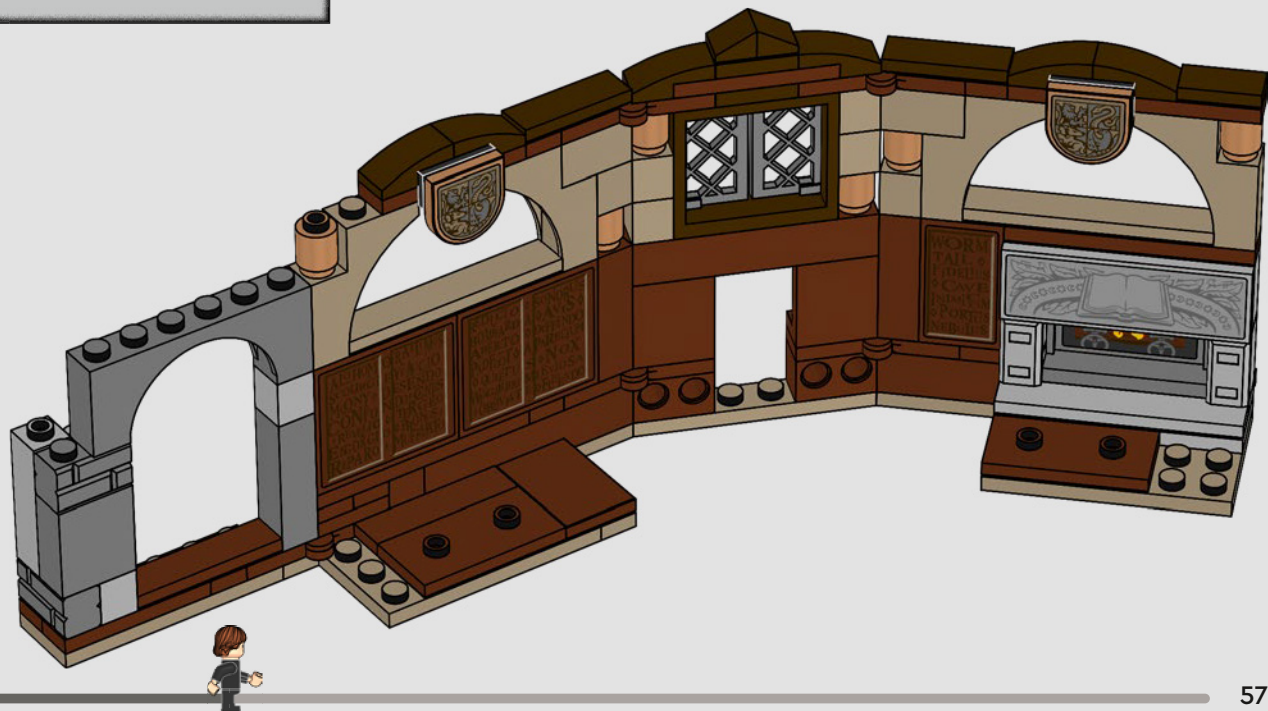

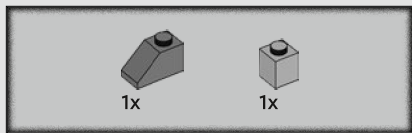

66

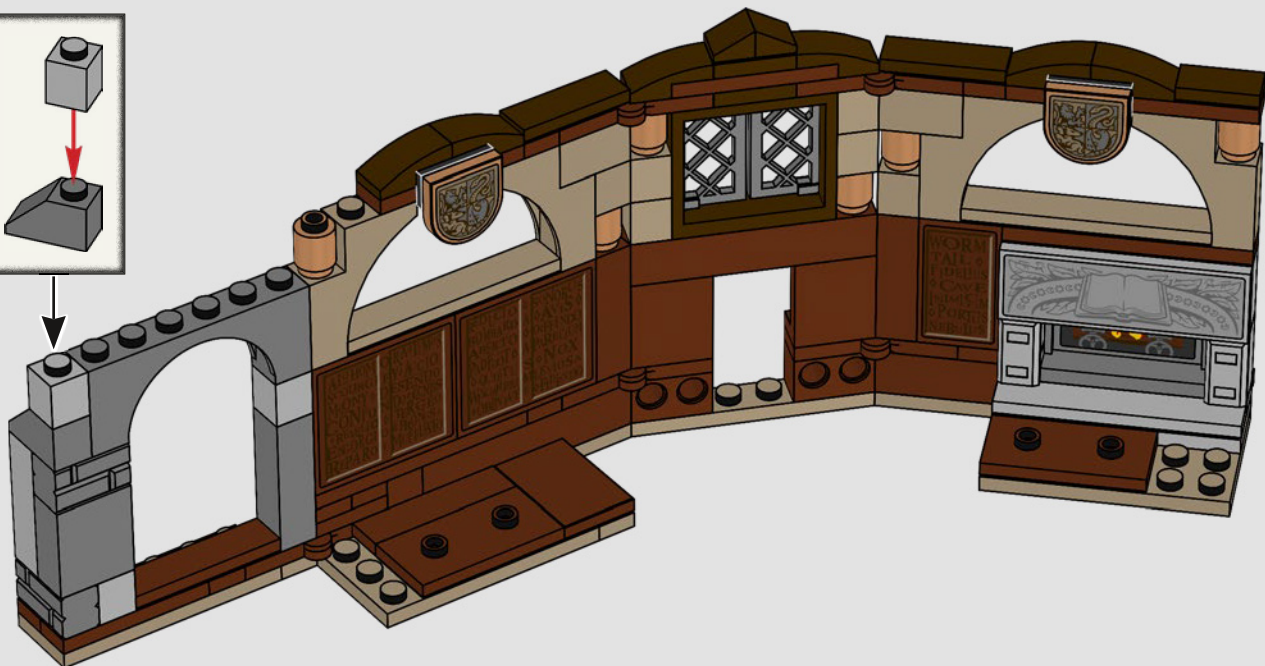
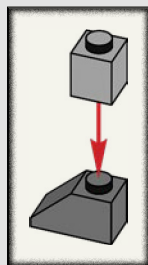

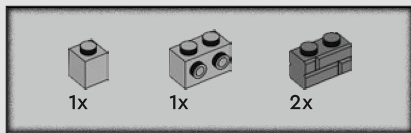

67

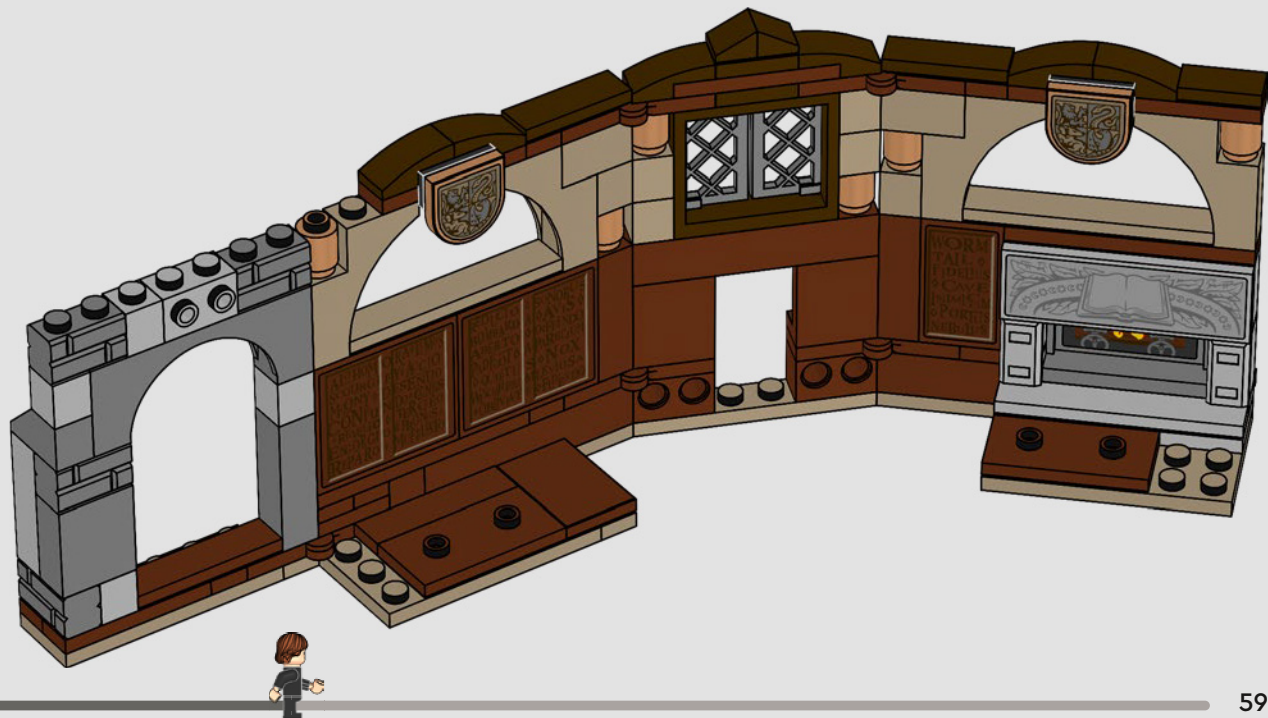

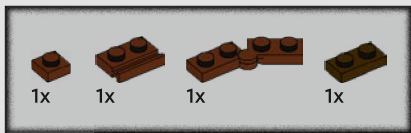

68

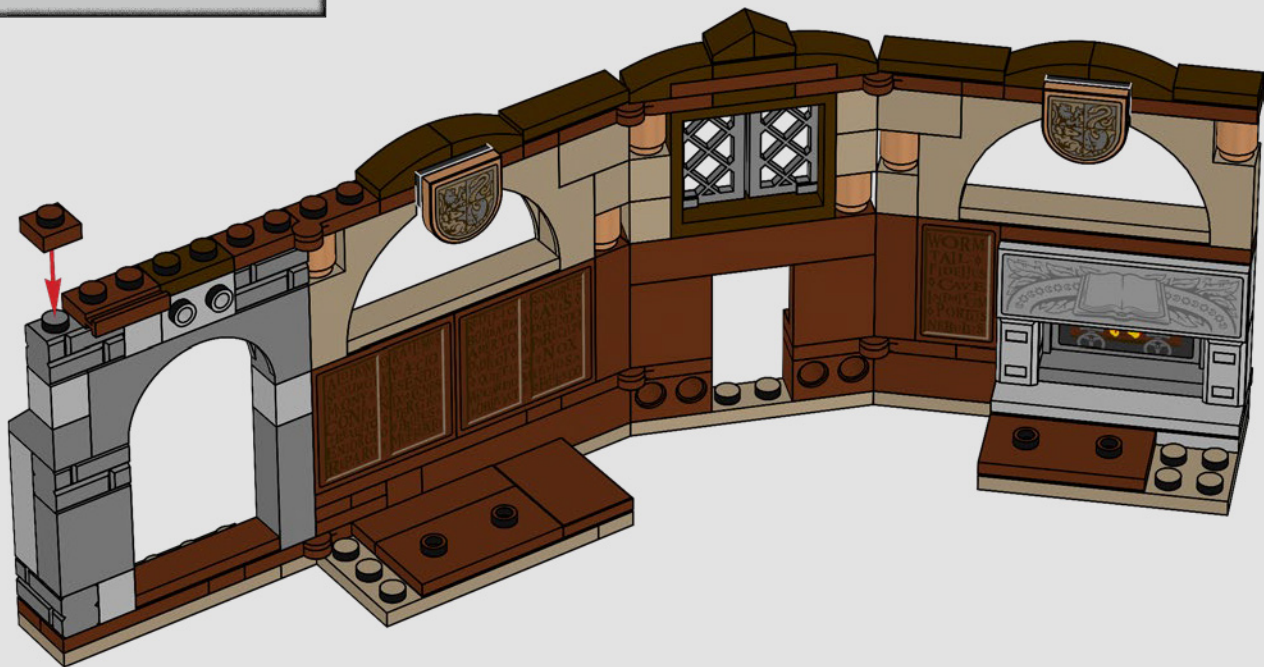

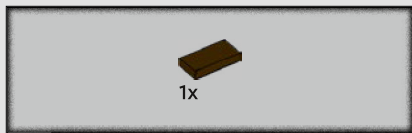

69

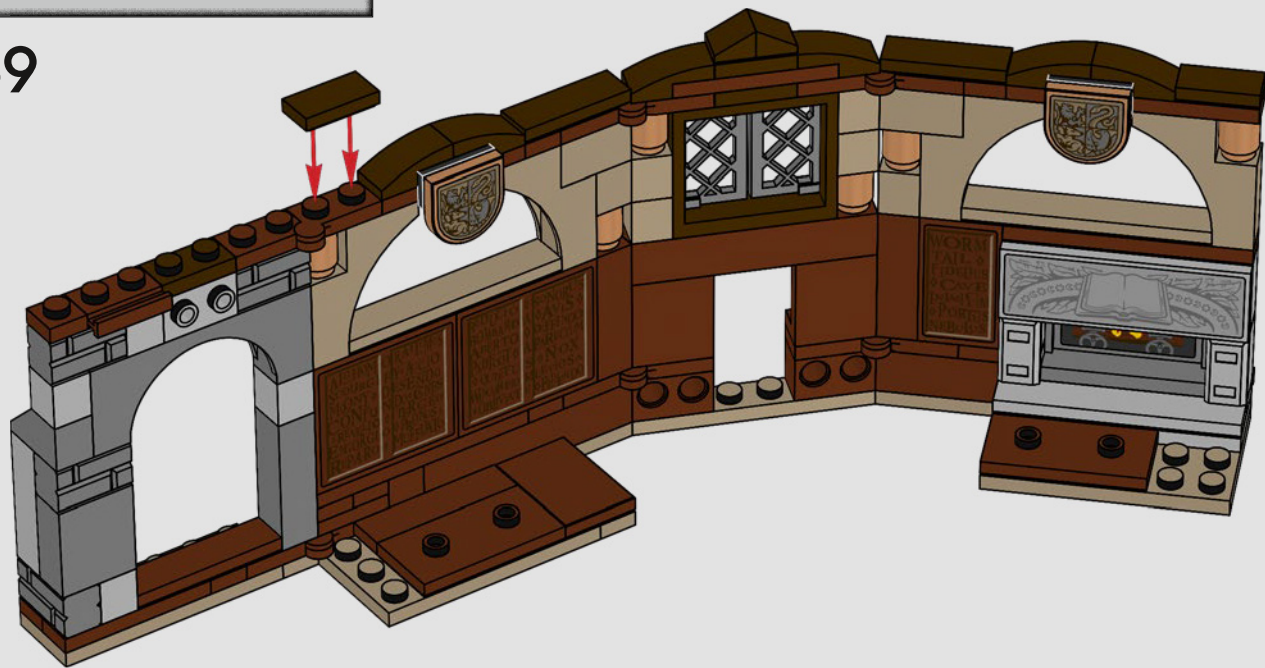

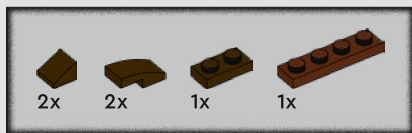

70

1

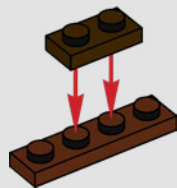

2

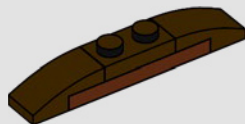

3

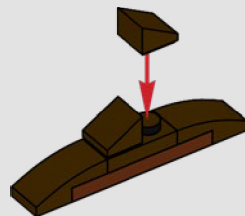

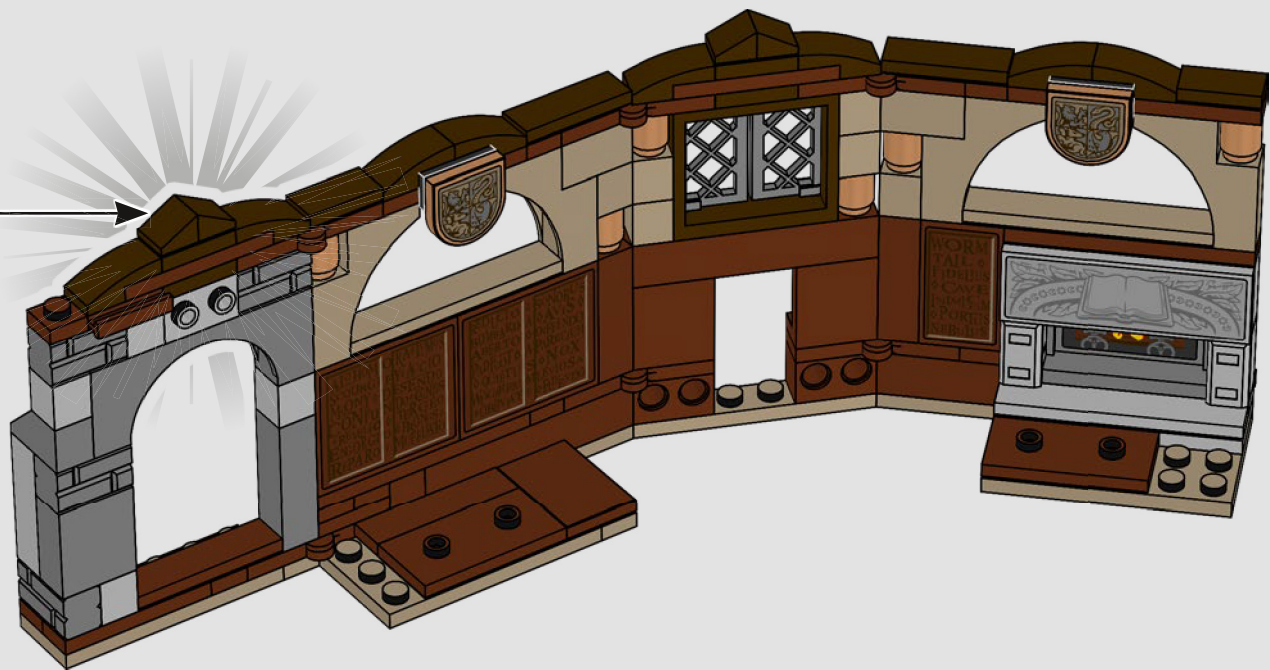

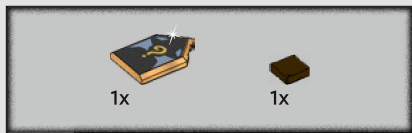

71

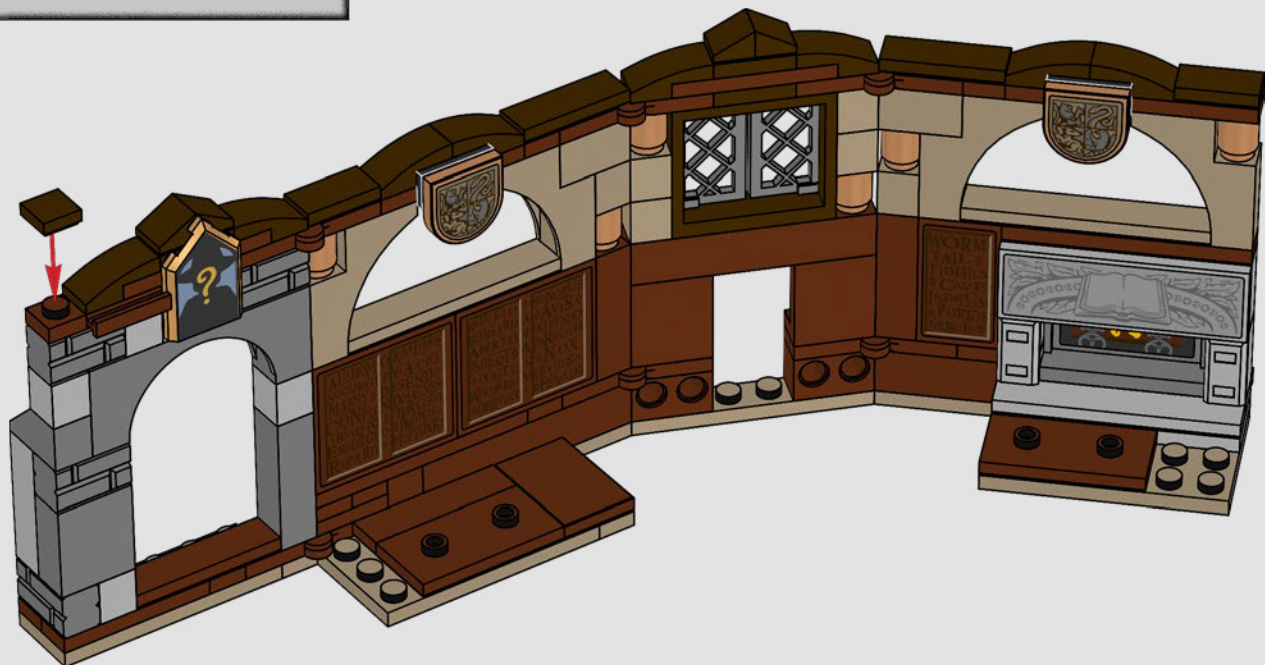



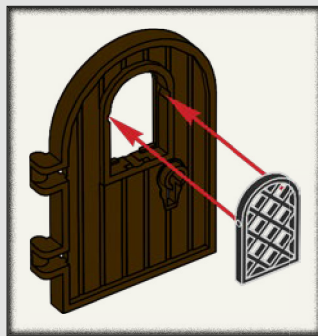
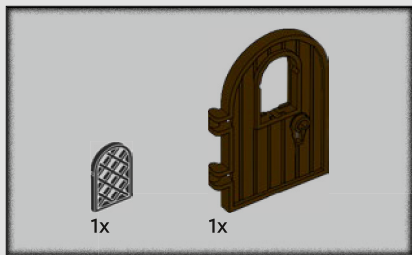

72

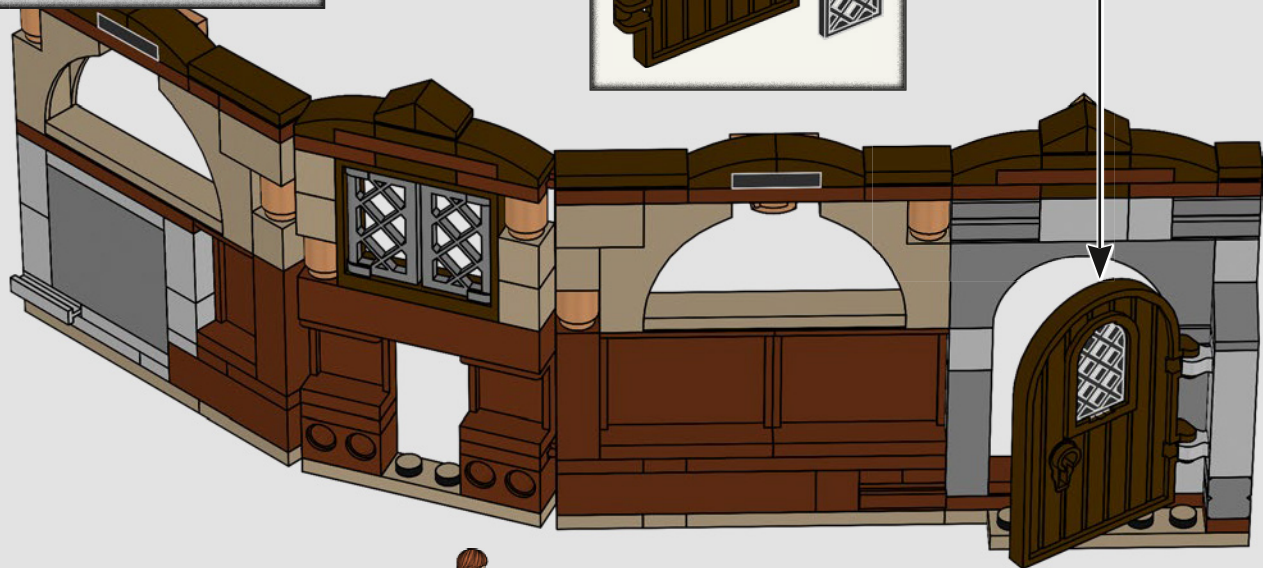

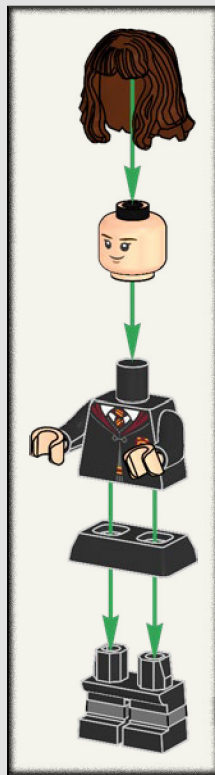

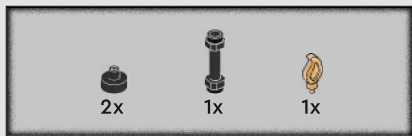

73

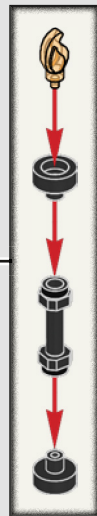
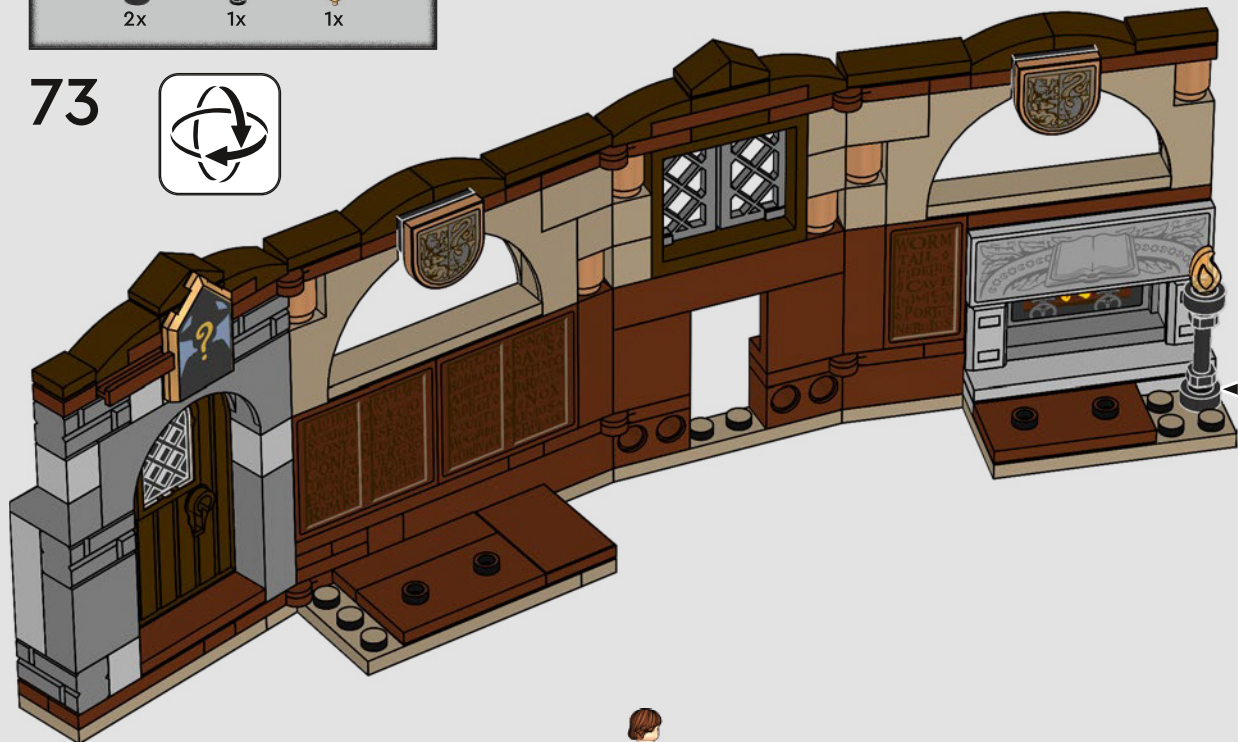



74

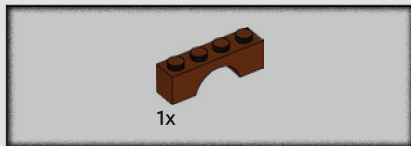
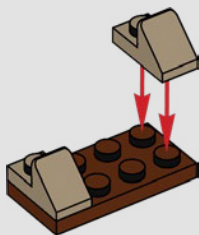

75

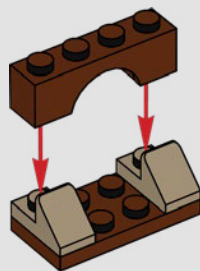

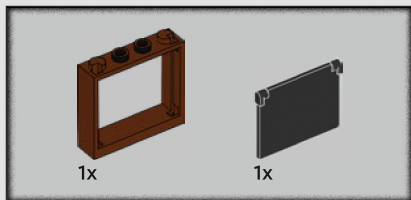

76

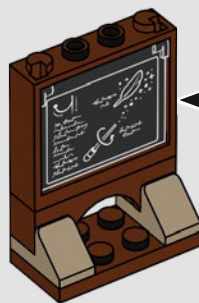
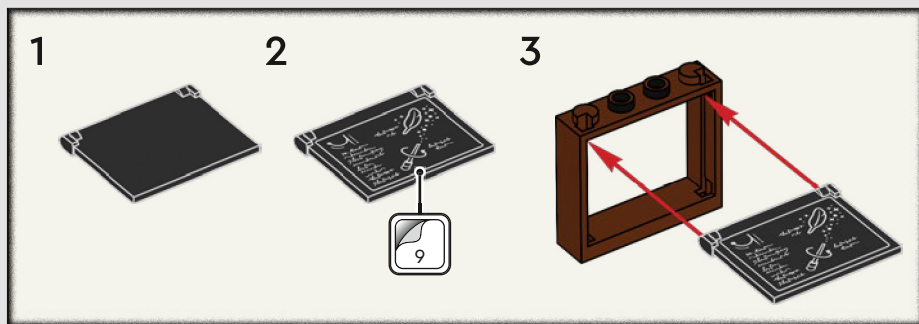

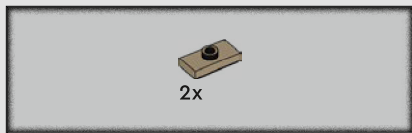

77

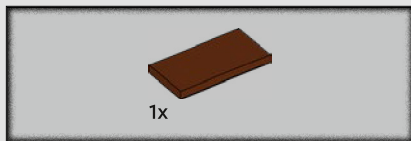
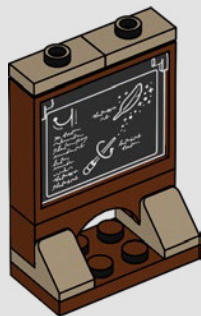

78



79

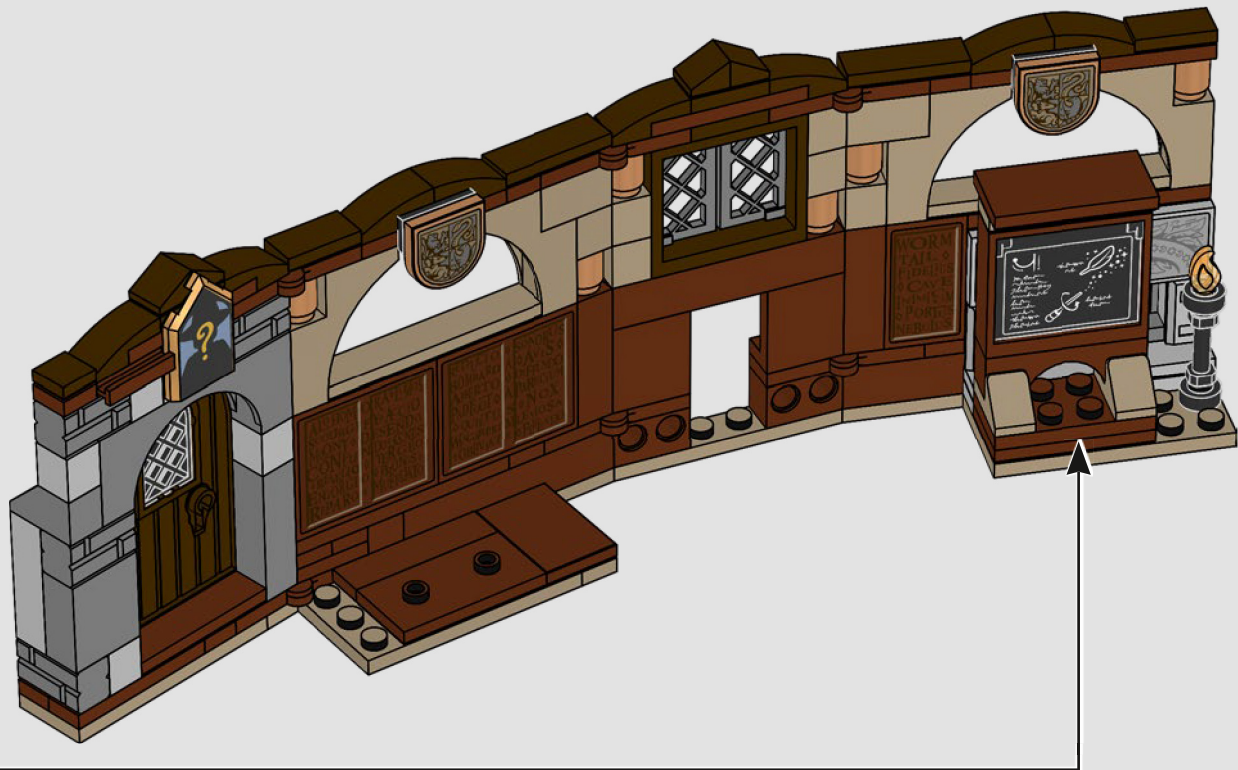

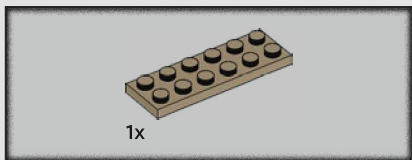
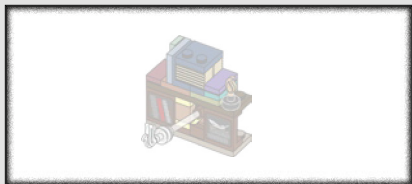

80

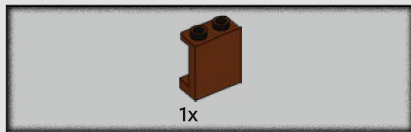
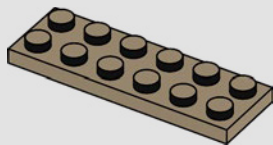

81

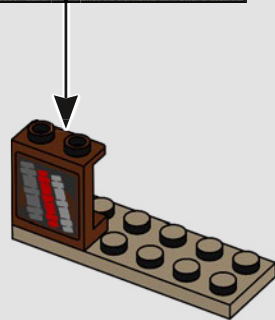
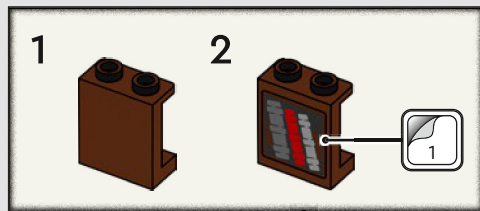





82

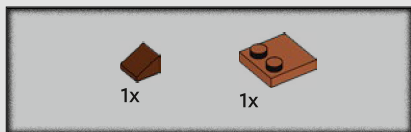
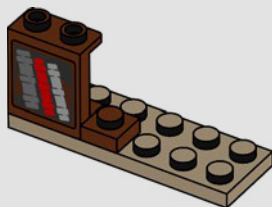

83

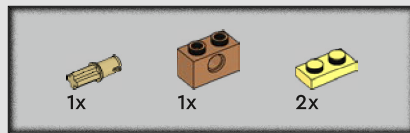
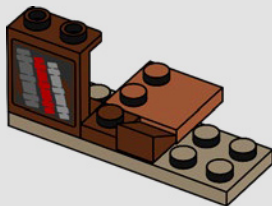

84

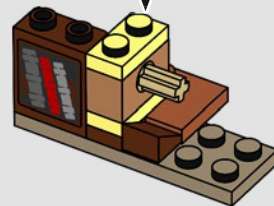
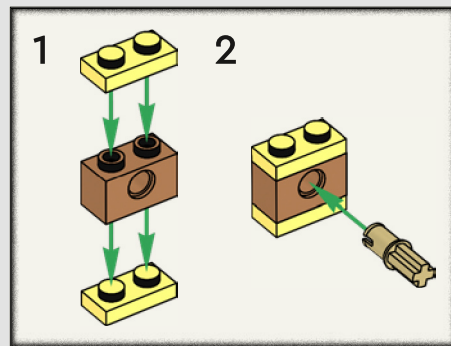

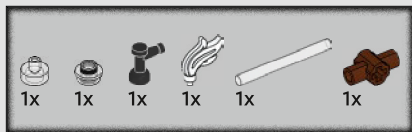

# 85

1

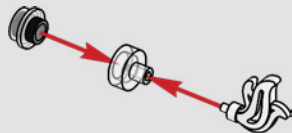

2

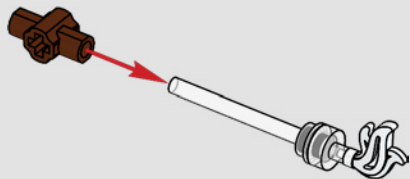

3

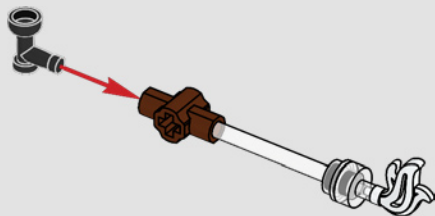



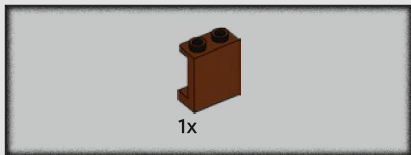

86

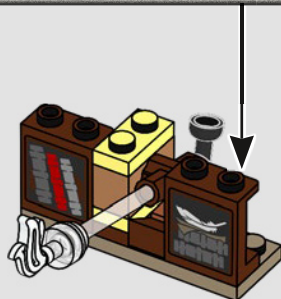
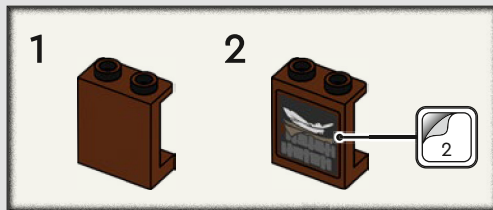

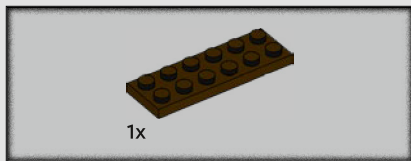

87

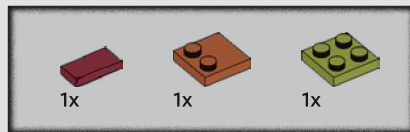
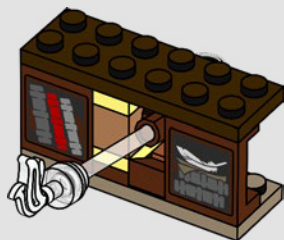

88

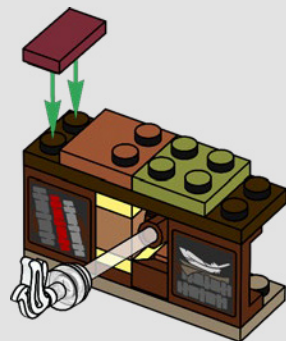

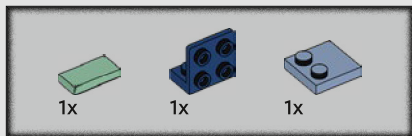

89

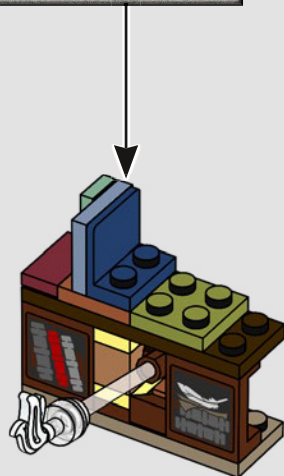
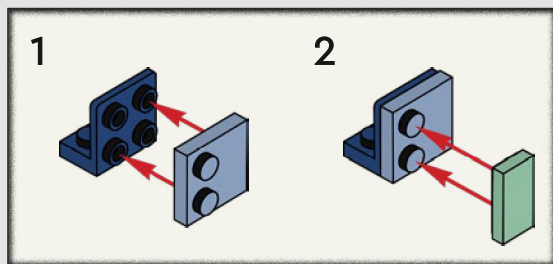

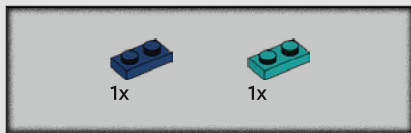

90

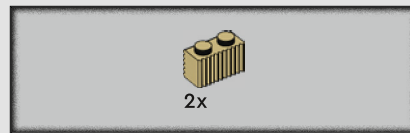
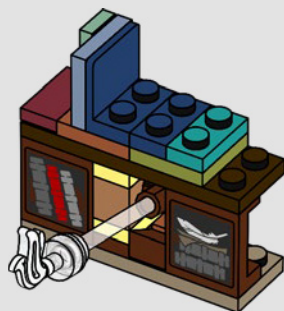

91



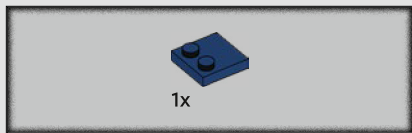

92

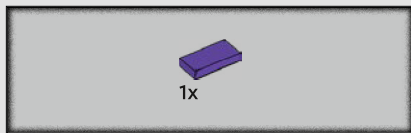
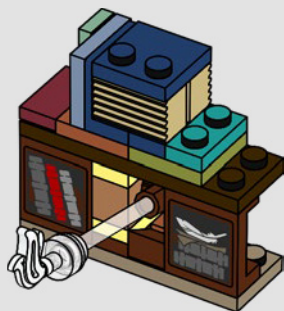

93

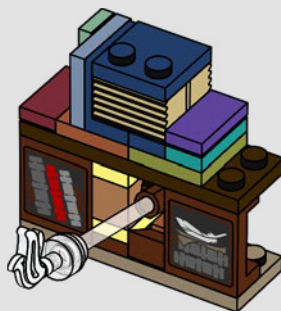





94

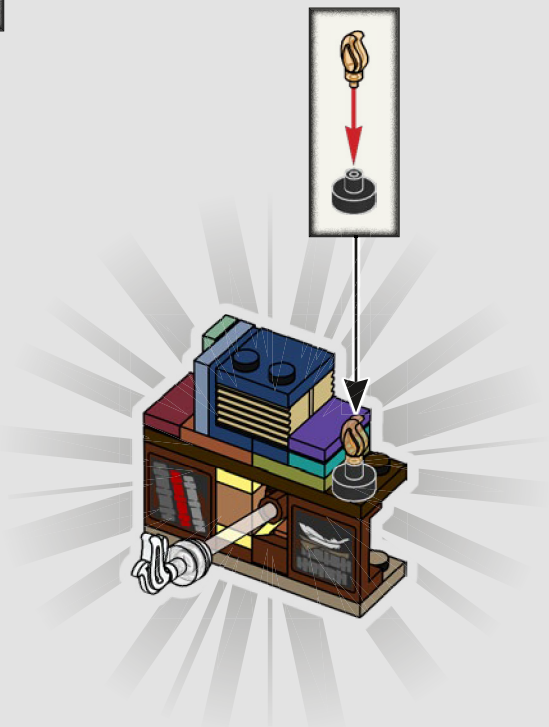

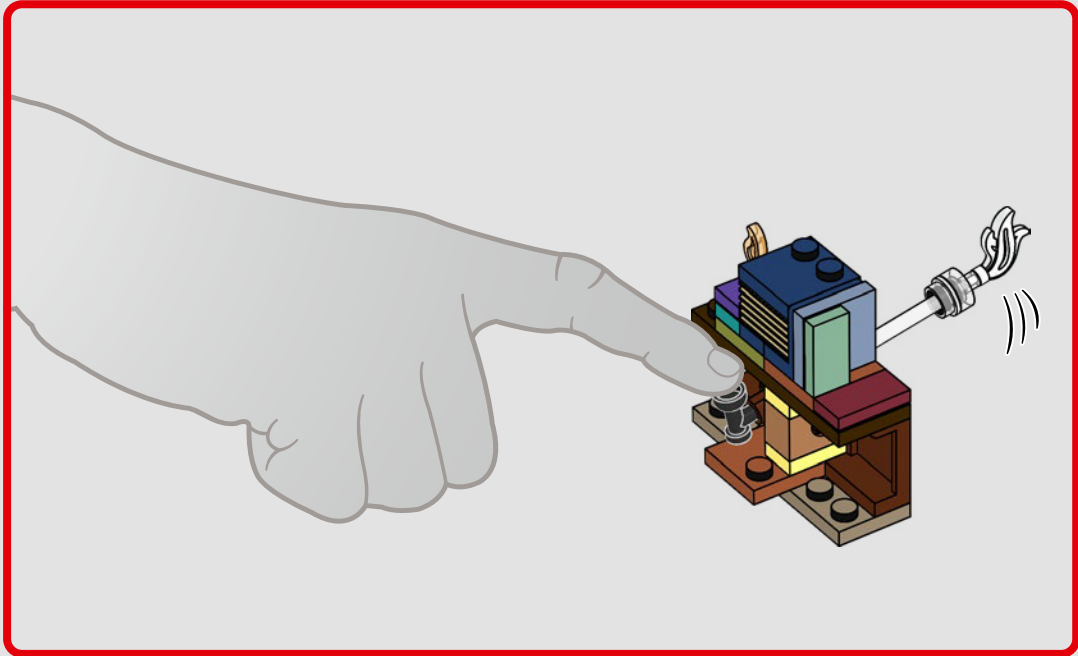

95

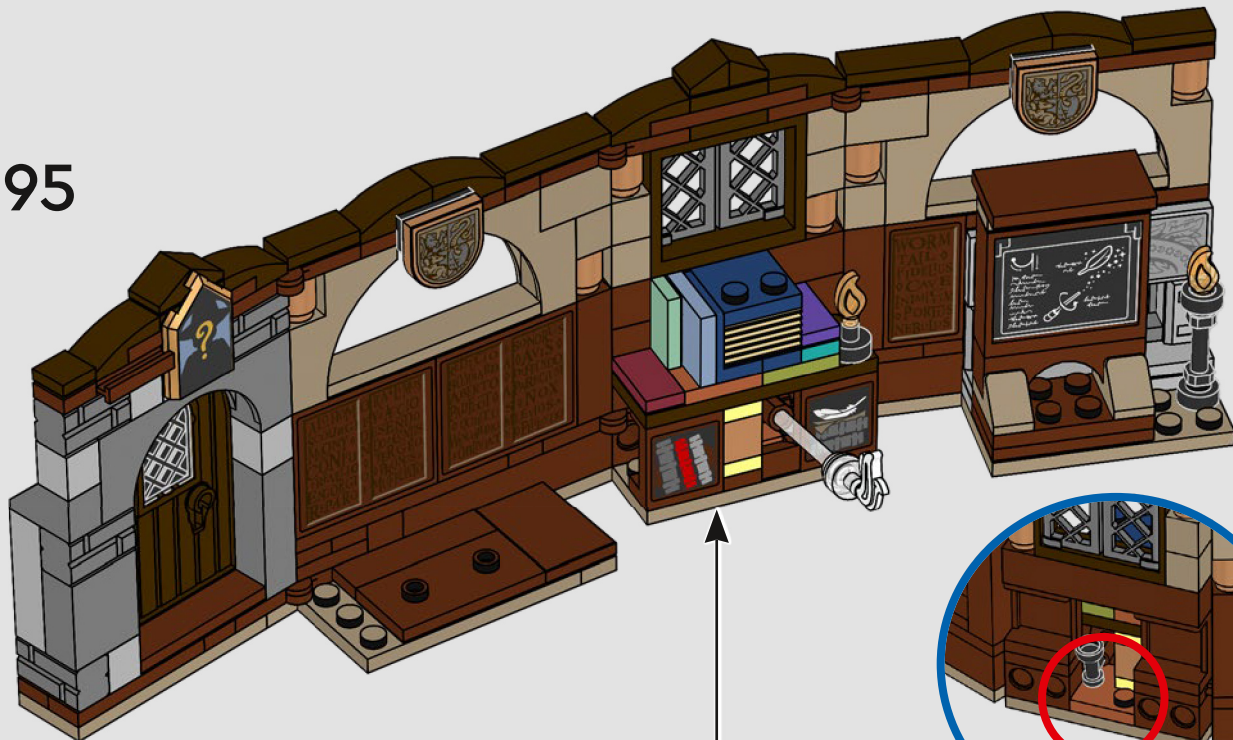

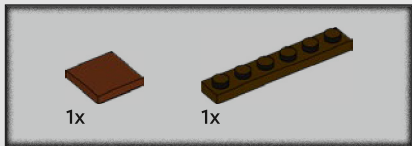

96

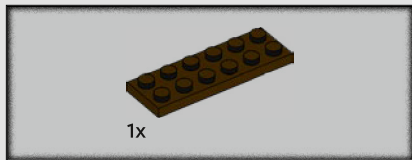
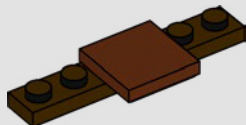

97

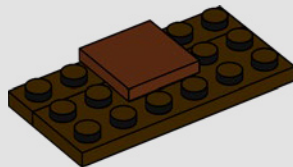



98

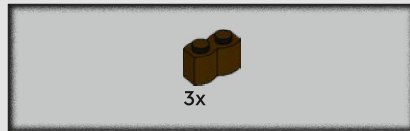
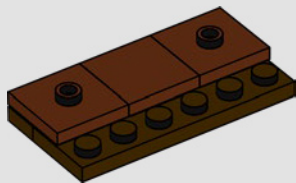

99

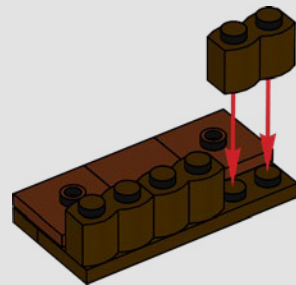

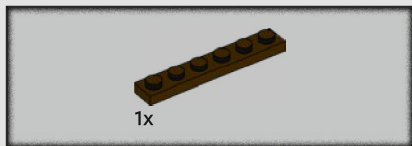

100

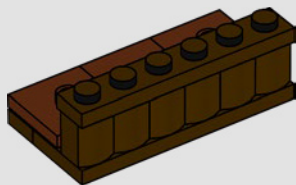

101



102

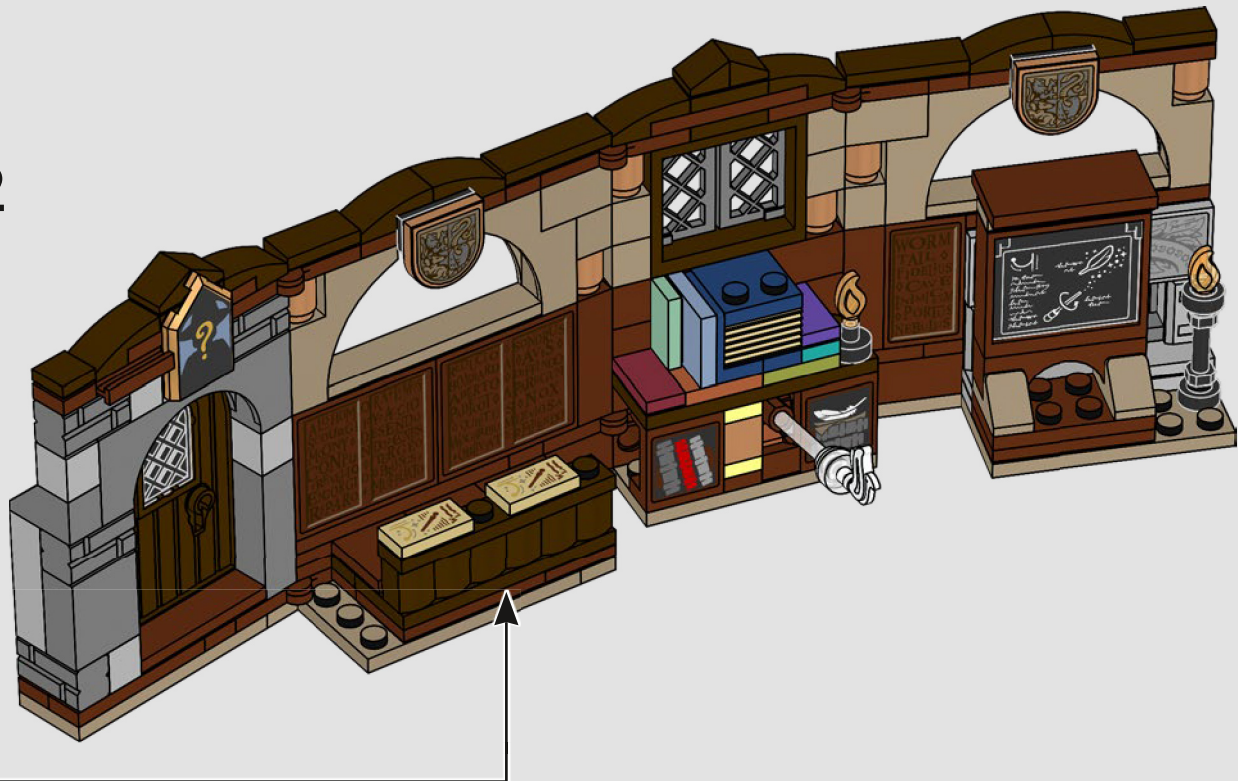

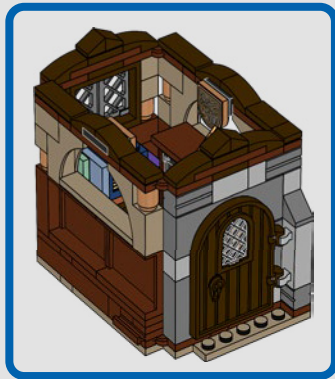







# Harry Potter



76435



Build the most detailed  
**HOGWARTS™  
CASTLE**

Construisez  
**LE CHÂTEAU  
DE POUDLARD**  
le plus détaillé

Construye  
**EL CASTILLO  
DE HOGWARTS™**  
más detallado



76447



76426

Each set sold separately and available for  
different periods of time

Les ensembles sont vendus séparément et à des  
périodes différentes.

Cada set se vende por separado y está  
disponible durante un cierto período de tiempo.



# Harry Potter



76442

Each set sold separately and available for different periods of time

Les ensembles sont vendus séparément et à des périodes différentes.

Cada set se vende por separado y está disponible durante un cierto período de tiempo.



Build the most detailed  
**HOGWARTS™  
CASTLE**

Construisez  
**LE CHÂTEAU  
DE POUDLARD**  
le plus détaillé

Construye  
**EL CASTILLO  
DE HOGWARTS™**  
más detallado



76435

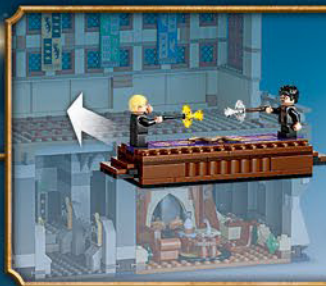



76441





76431

 3x  
6289366

 1x  
6544204

 1x  
4666579

 2x  
4655900

 2x  
6516454

 1x  
6331084

 3x  
6186675

 1x  
459926

 1x  
6173105

 1x  
4596914

 1x  
6378773

 2x  
6016172

 1x  
6359881

 1x  
6357268

 1x  
6353176

 1x  
6514144

 1x  
6125719

 2x  
6394948

 1x  
6507895

 1x  
6510164

 1x  
6507886

 1x  
6213777

 1x  
6398673

 1x  
6270031

 6x  
6001824

 1x  
4549436

 2x  
6093064

 2x  
6092591

 2x  
4521914

 1x  
4528604

 1x  
6132768

 4x  
6283824

 1x  
4626904

 1x  
6015424

 2x  
4507047

 2x  
4550329

 2x  
6167894

 1x  
4528981

 1x  
6224472

 1x  
6214810

 1x  
4616578

 1x  
4539090

 2x  
6514274

 2x  
6270028

 1x  
4504376

 10x  
4221744

 2x  
6177699

 1x  
4211242

 1x  
6459423

 1x  
6403106

 4x  
6064188

 2x  
6151461

 1x  
6398342

 2x  
4645103

 2x  
4565394

 1x  
4271949

 1x  
6311441

 4x  
4211190

 1x  
6177697

 1x  
4595889

 1x  
4211225

 2x  
6524967

 2x  
4211194

 6x  
6416695



1x  
4211186



2x  
6307618



1x  
4579690



2x  
4211193



3x  
4221590



3x  
6225242



1x  
4558953



1x  
4211399



4x  
4211389



1x  
6320356



2x  
6134378



1x  
6015344



1x  
4211568



1x  
4211353



1x  
4211429



1x  
4211445



1x  
4211395



1x  
4211549



1x  
6318584



2x  
6201647



1x  
6396489



2x  
6388124



4x  
6000311



1x  
4210978



1x  
4211135



1x  
6008715



1x  
6106191



1x  
4613192



1x  
6516452



1x  
6233913



1x  
6236271



1x  
6478297



4x  
6259071



1x  
6516867



3x  
4519970



1x  
6005225



4x  
6058221



8x  
6046943



2x  
4566688



2x  
6167928



4x  
4518687



1x  
6328181



1x  
6254792



2x  
6223039



6x  
6300103



1x  
6192920



2x  
6513939



1x  
6079617



1x  
6529296



LEGO.com/service



YOU COULD  
**WIN**



Scan this QR code or go to  
**LEGO.COM/PRODUCTFEEDBACK** and give  
us your short feedback about this LEGO® set  
for a chance to win a cool LEGO prize.

Terms and Conditions apply\*



**EN: YOU COULD WIN.** Terms and Conditions apply\* **DE: Du könntest GEWINNEN.** Es gelten die Teilnahmebedingungen\* **FR: Tu pourrais GAGNER.** Des conditions s'appliquent\* **IT: Potresti VINCERE tu.** Termini e condizioni sono applicabili\* **ES: Puedes GANAR.** Aplican términos y condiciones\* **PT: Poderá GANHAR.** Aplicam-se termos e condições\* **ZH: 轻松获奖. 条款和条件适用\*** **PL: Szansa na WYGRANĄ.** Obowiązują warunki korzystania\* **CS: Máte šanci VYHRÁT.** Platí všeobecné smluvní podmínky\* **SK: Máte šancu VYHRAŤ.** Platia všeobecné zmluvné podmienky\* **HU: TE IS NYERHETSZ.** Felhasználási feltételek érvényesek\* **RO: Ai putea CÂȘTIGA.** Se aplică termenii și condiții\* **BG: Можете да СПЕЧЕЛИТЕ.** Има определени правила и условия\* **LV: Tu vari LAIMĒT.** Ir spēkā noteikumi un nosacījumi.\* **ET: Sul on võimalus VÕITA.** Kehtivad tingimused\* **LT: Jūs galite LAIMĖTI.** Taikomos sąlygos\*

\*[LEGO.com/productfeedback-terms](https://www.lego.com/productfeedback/terms)