



40709





Get excited about our new packaging!

We're switching from plastic to paper-based packaging. That's why you might find a mix of paper and plastic in our boxes!

Nos nouveaux emballages vous emballeront !

Nous passons des emballages en plastique aux emballages à base de papier. C'est pourquoi vous pourriez trouver un mélange de papier et de plastique dans nos boîtes !

¡Te presentamos nuestros nuevos empaques!

Estamos sustituyendo las bolsas de plástico por bolsas con base de papel. ¡Por eso, puedes encontrar una mezcla de papel y de plástico en nuestras cajas!

[LEGO.com/sustainable-packaging](https://www.lego.com/sustainable-packaging)

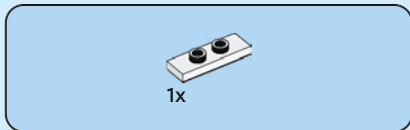

1





2x

2

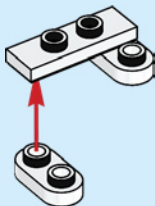



1x

3



2x

4

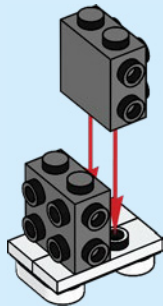



2x

5

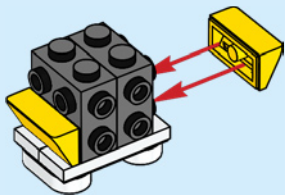

6





2x

6

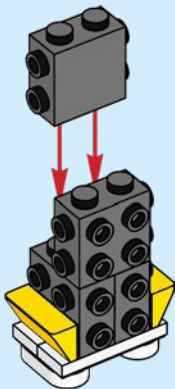

2x

7

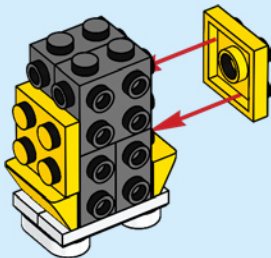



1x



1x

8

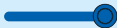
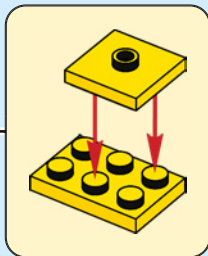
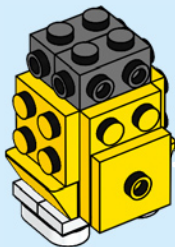



1x



1x

9

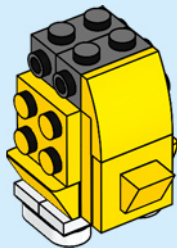

1x

10

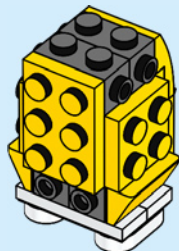



2x



2x

11

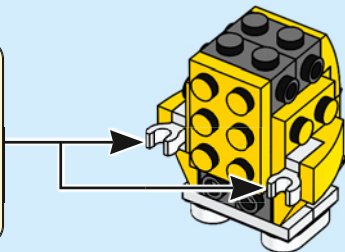
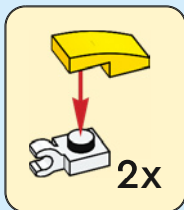



2x

12

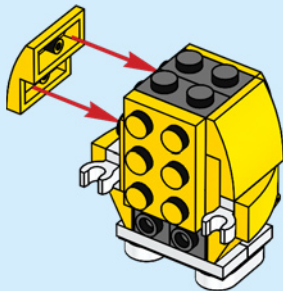

1x

13

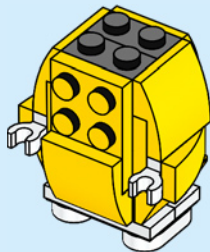



1x



1x



2x

14

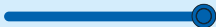
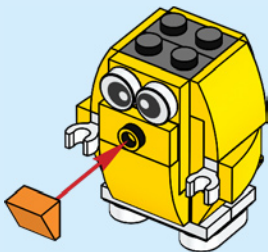



1x



1x

15

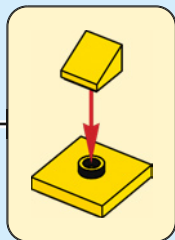
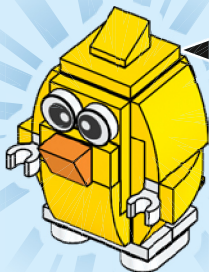

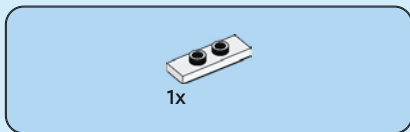
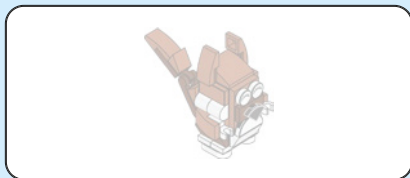

1

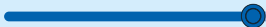



2x

2

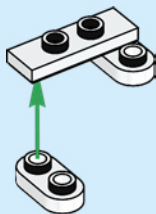

1x

3





2x

4

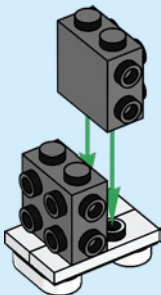



1x



2x

5

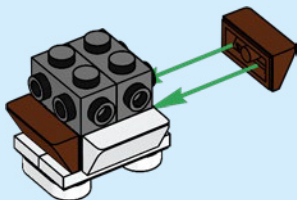

2x

6

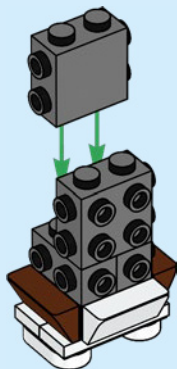



1x

7

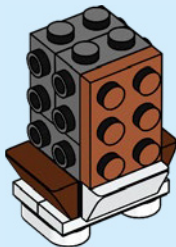



2x

8

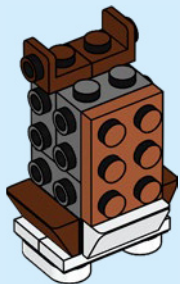

1x

9

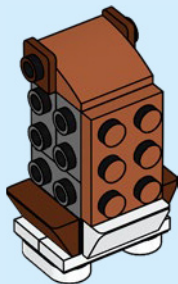



2x



2x



2x

10



1



2



2x

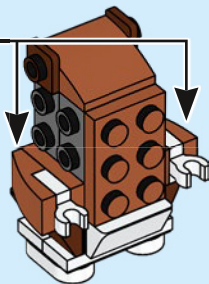



1x



2x

11

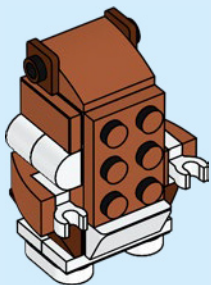

1x



1x

12

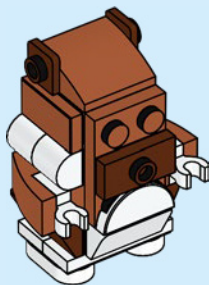



1x



2x

13

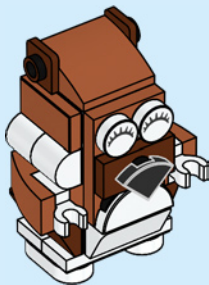



1x



2x

14

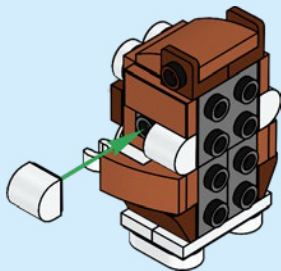

1x

15

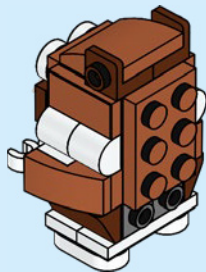



1x



1x

16

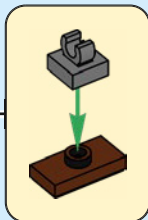
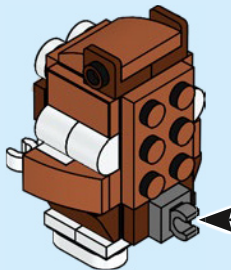



2x



1x



1x



1x

17

1

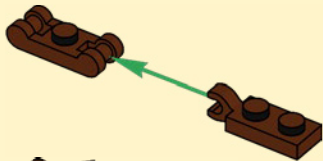

2

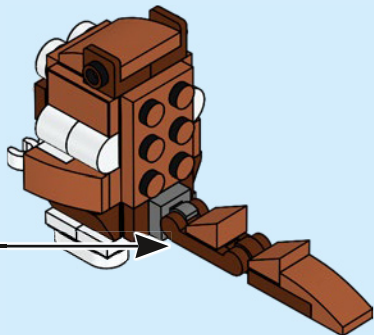
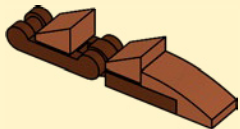



2x

18

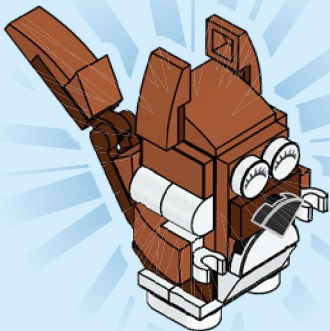

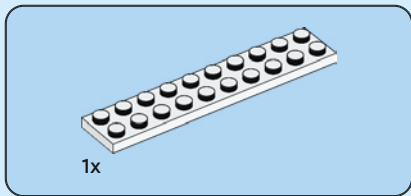
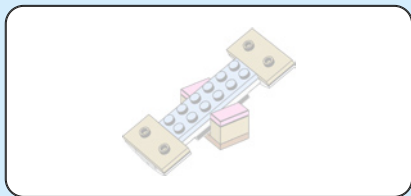

1

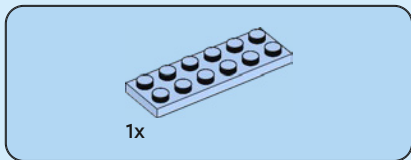
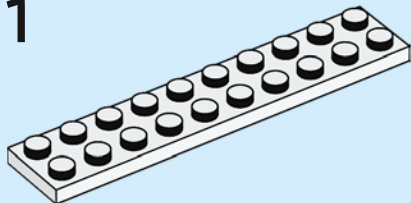

2

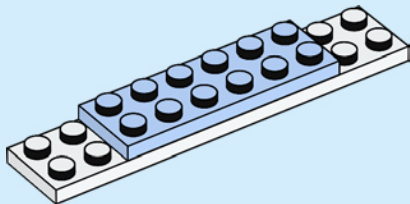



2x

3

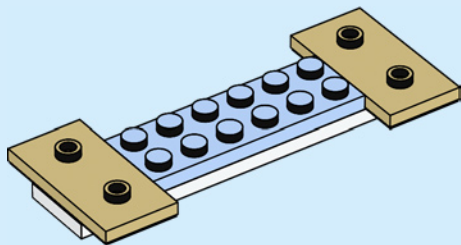

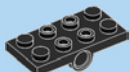

1x

4

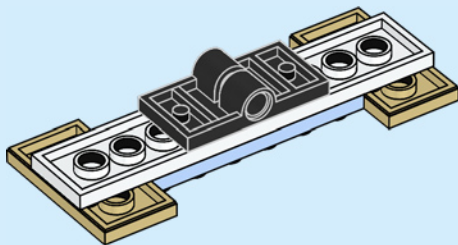



4x

5

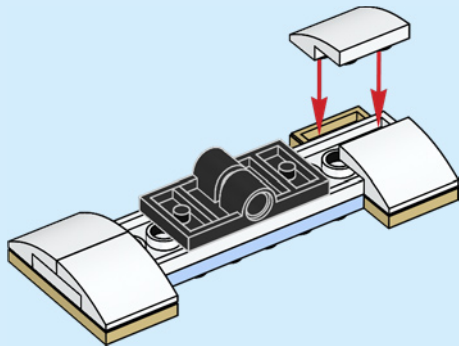



2x

6

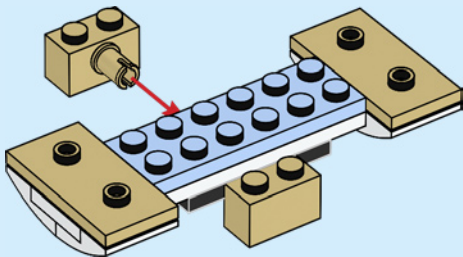



1x

7

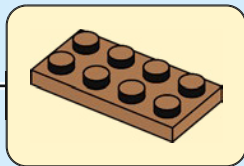
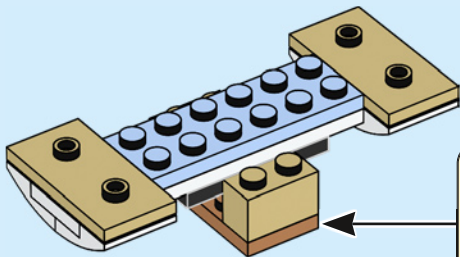



2x

8

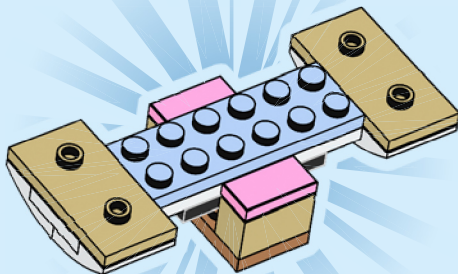

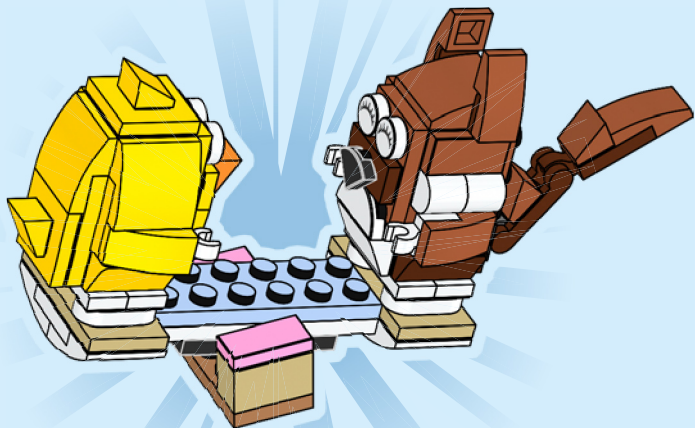

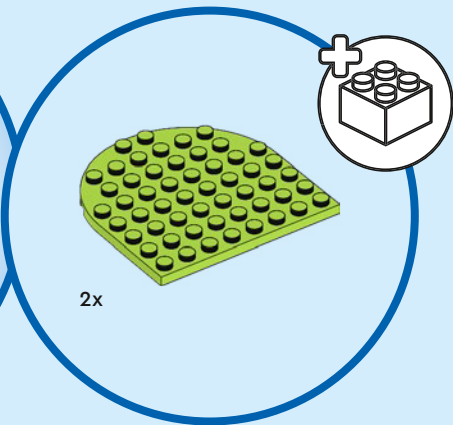

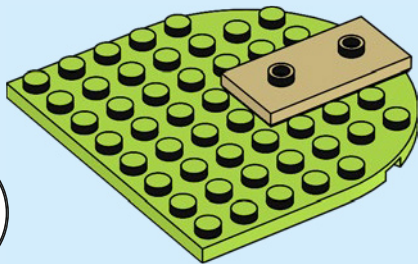
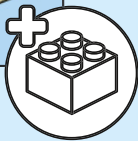
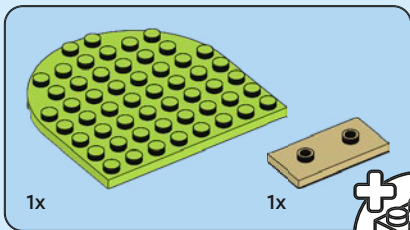
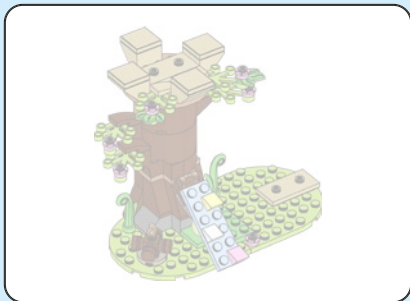

1

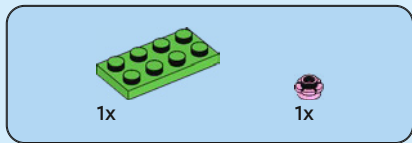

2

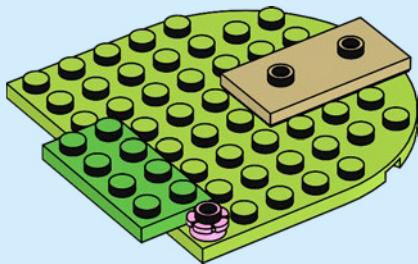

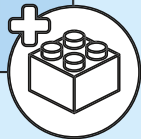
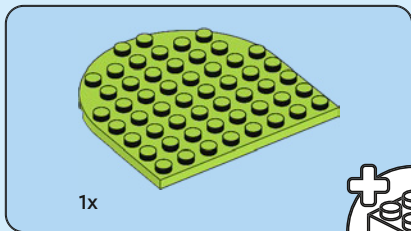

3

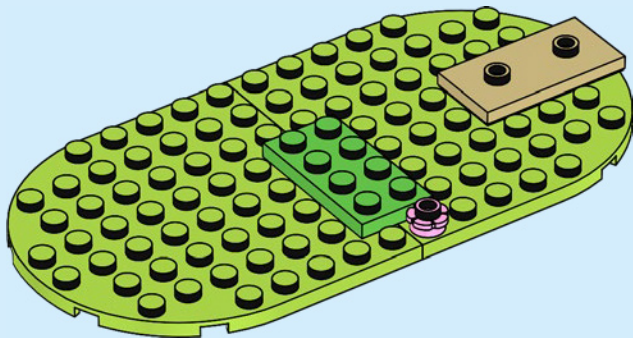

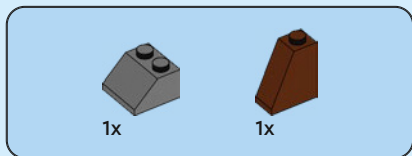

4

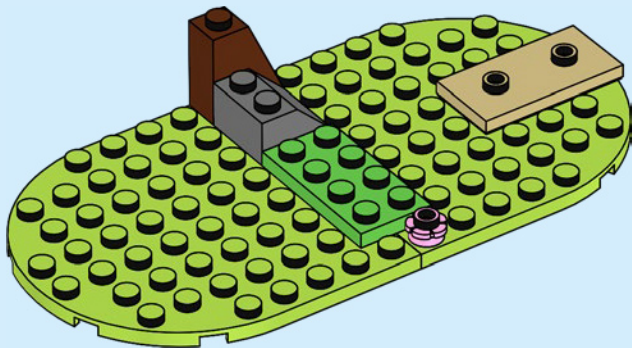



1x



1x

5

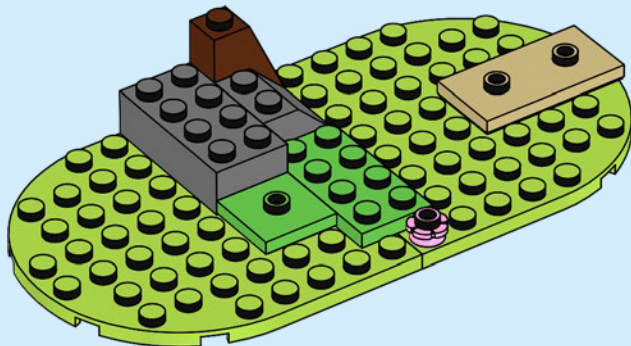

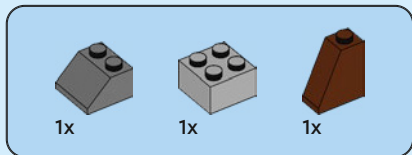

6

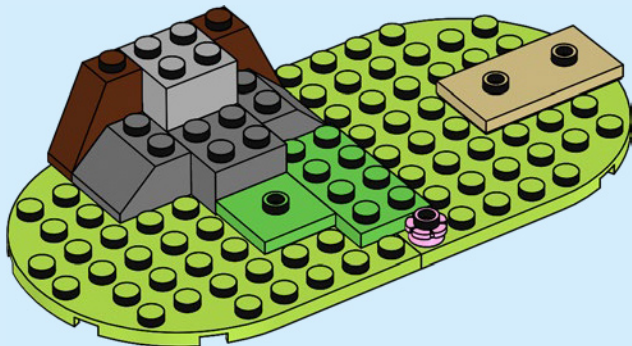



1x

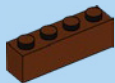

1x

7

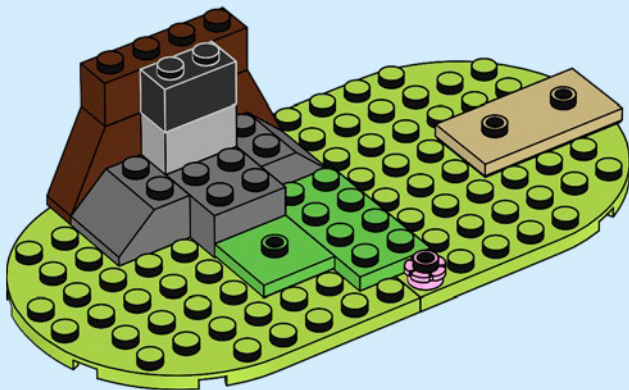



4x

8

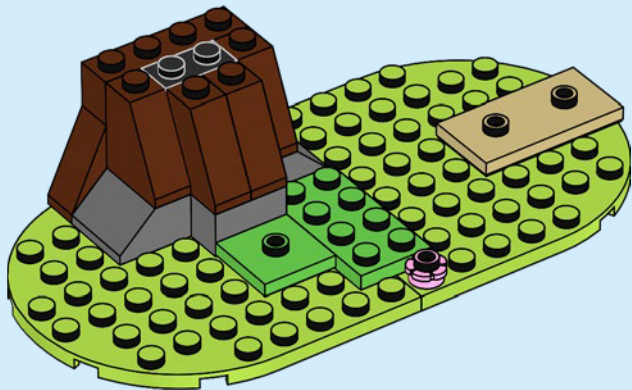



1x



1x

9

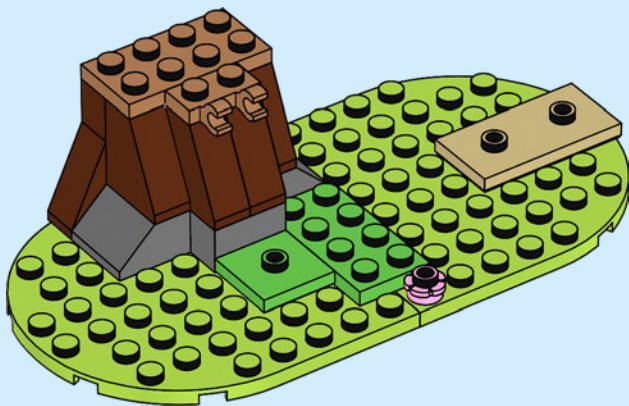

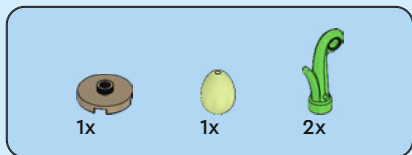

10

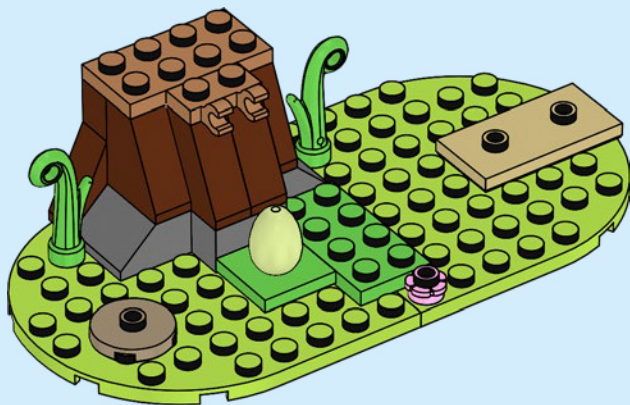

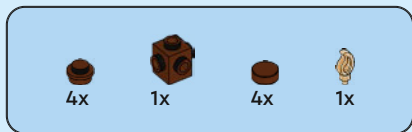

11

1



2

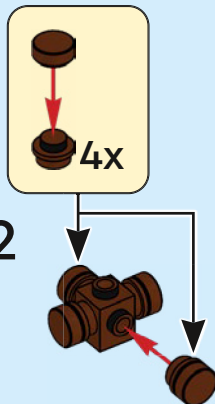

3

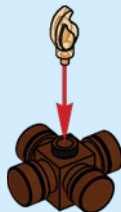

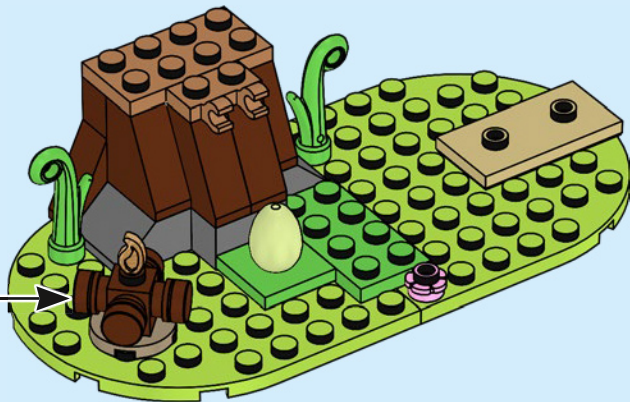

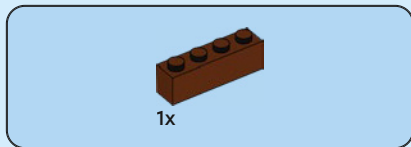

12

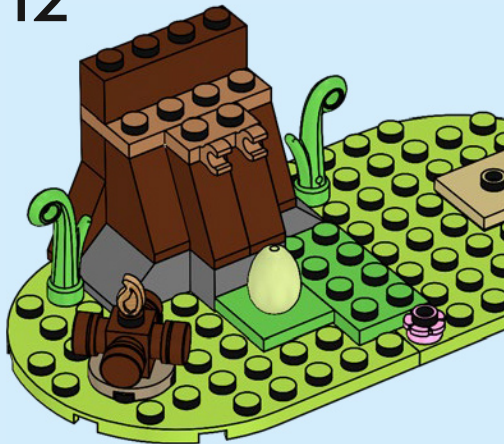



1x



1x

13

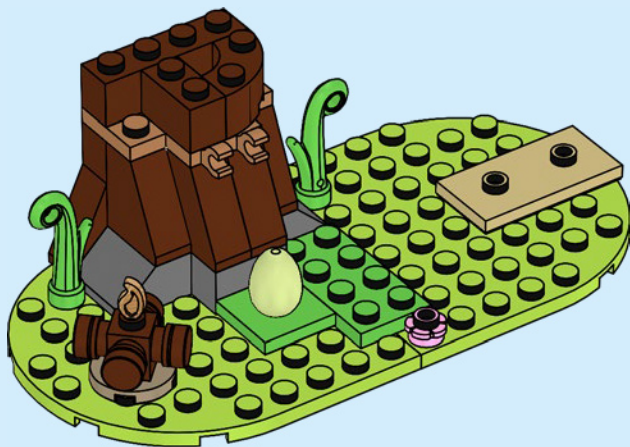



2x

14





1x



1x

15

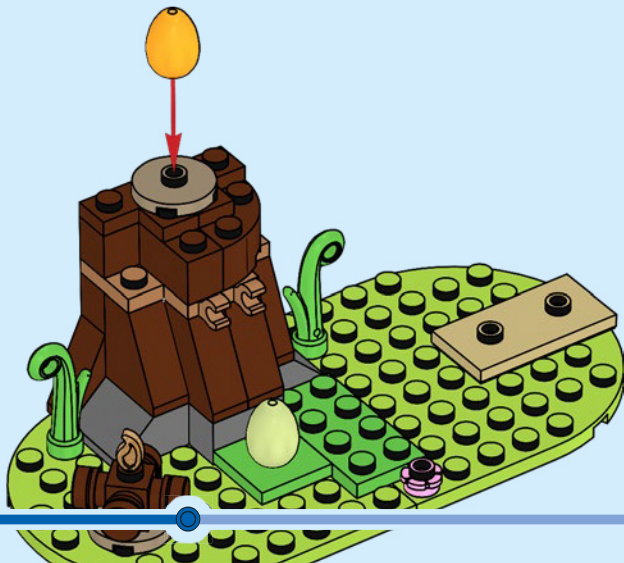



1x

16

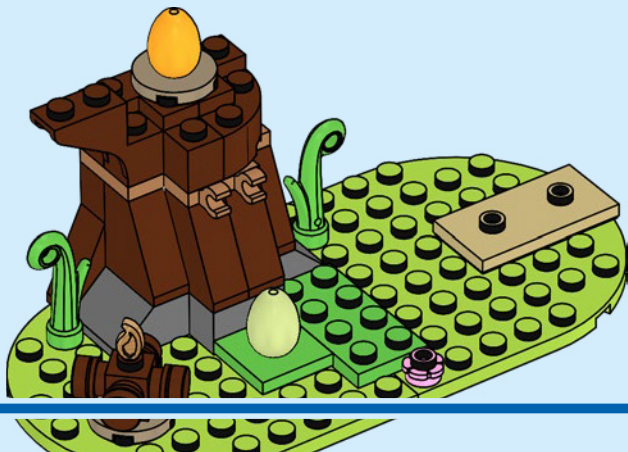

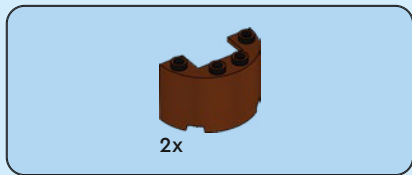

17

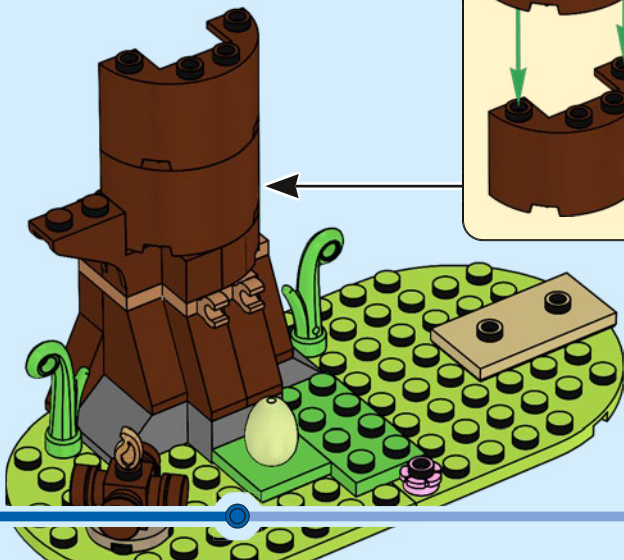
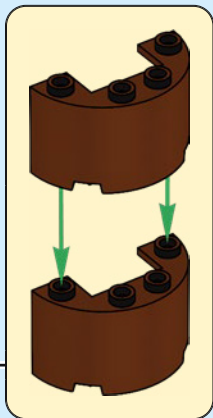



1x



1x

18

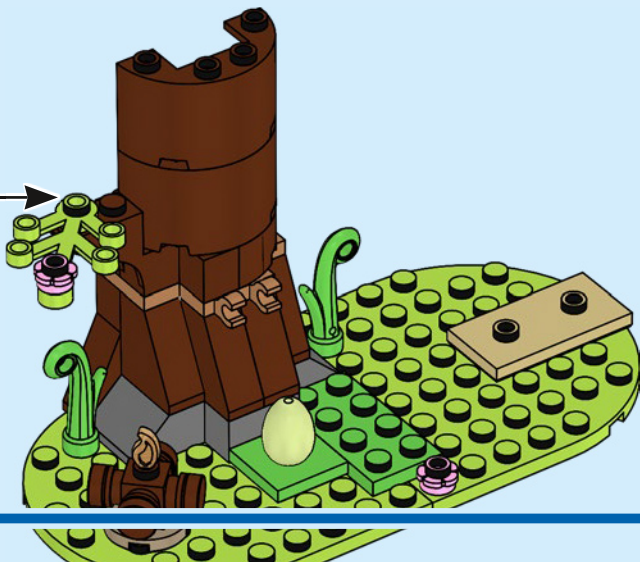
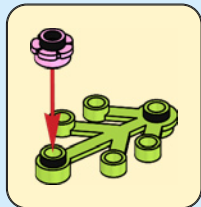



1x

19





2x

20

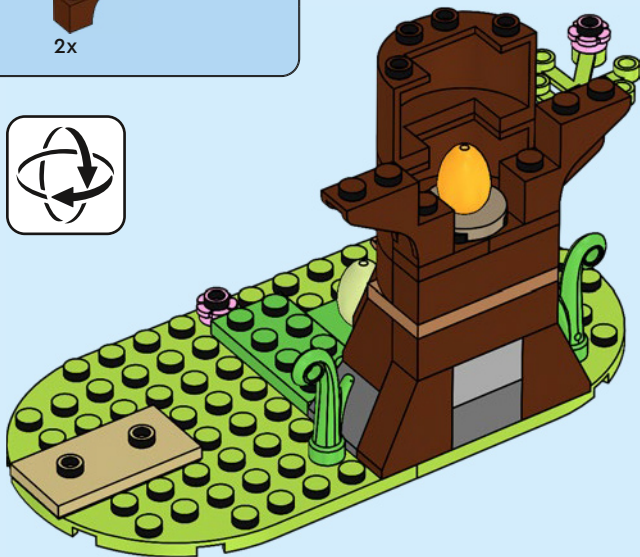

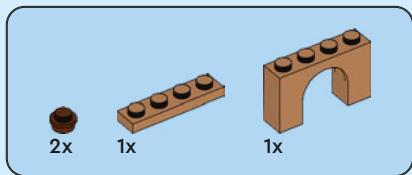

21

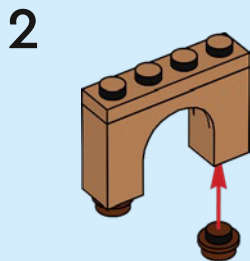
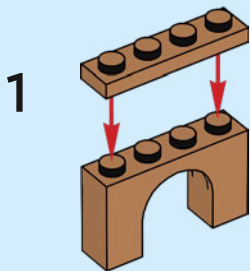

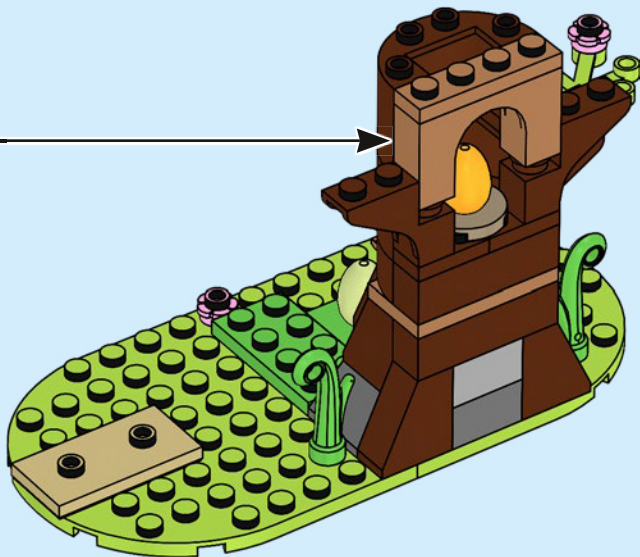



1x

22





2x



2x

23

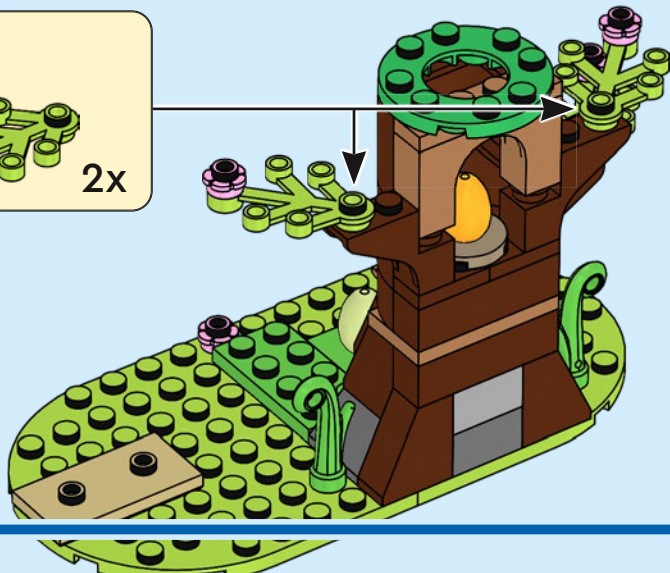
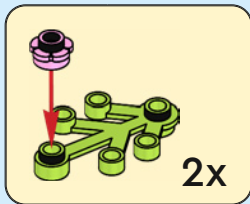



2x

24



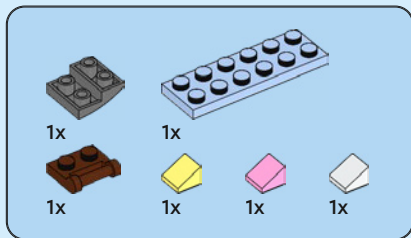

25

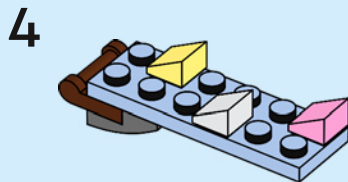
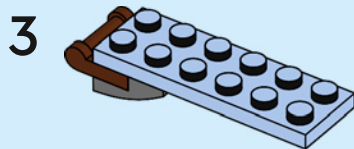
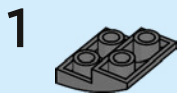

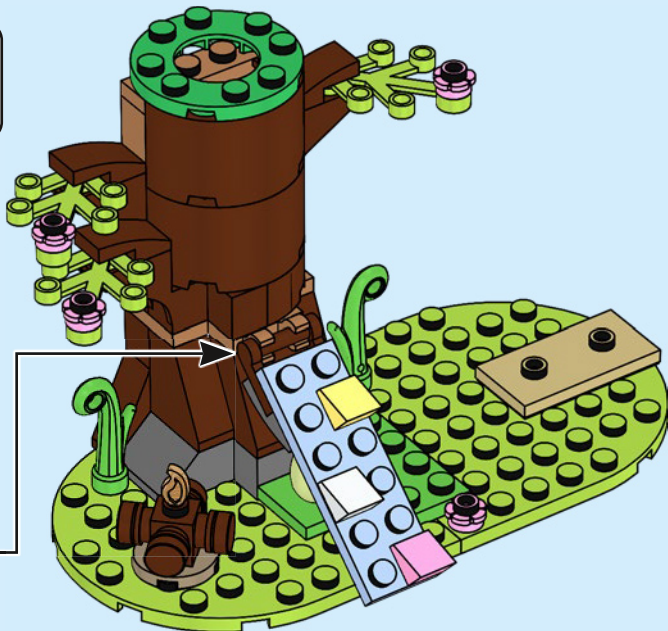

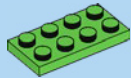

1x



1x

26

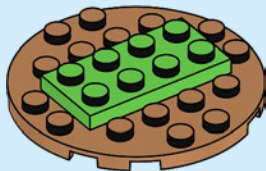

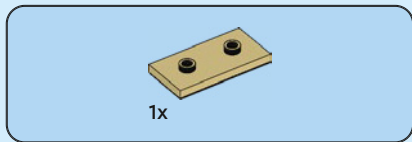

27

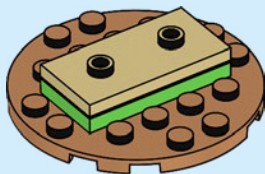



2x



2x

28

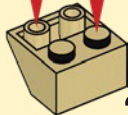

2x

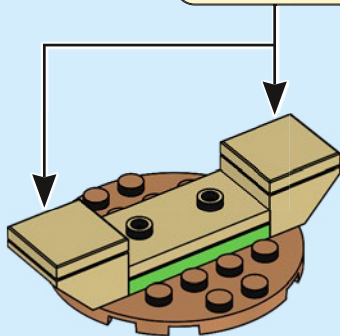



29

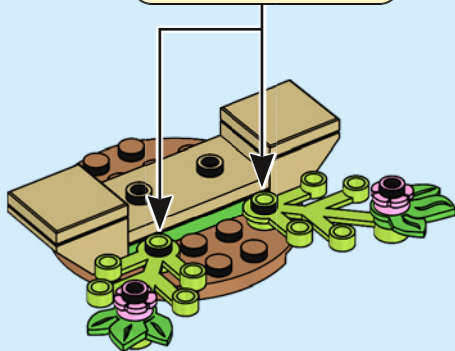
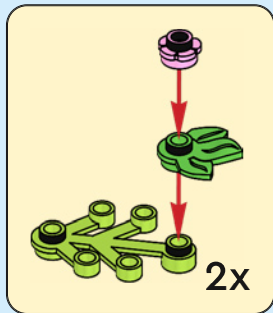



2x

30

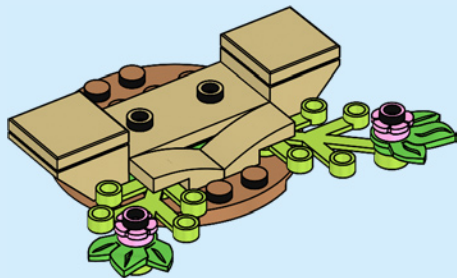



2x



2x

31

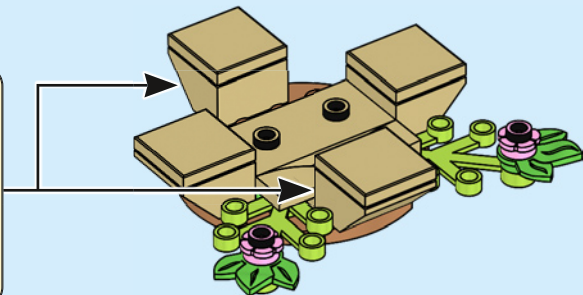
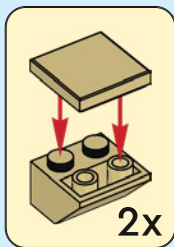



1x

32

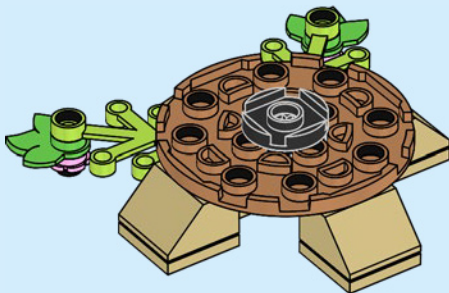

33

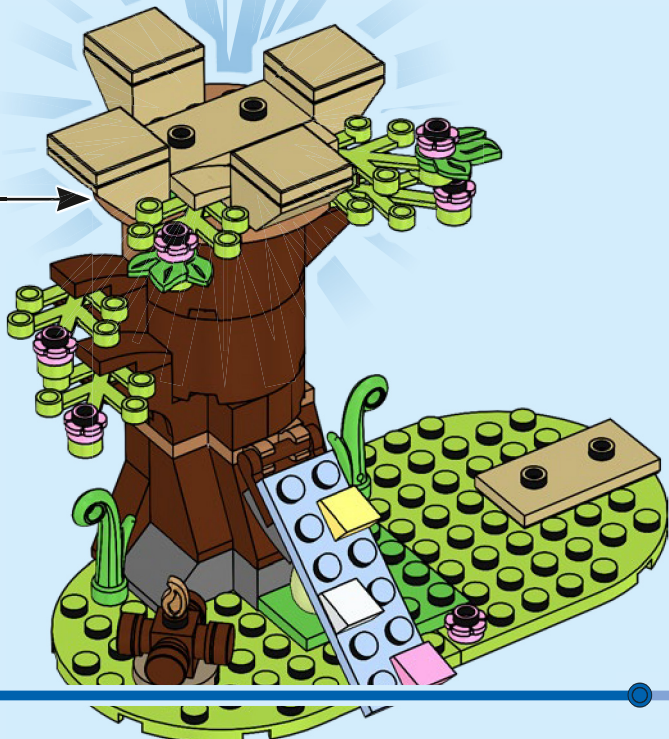





2x
6284604



2x
6284599



4x
6258135



1x
4504369



1x
6400114



4x
6347293



4x
6210272



1x
4547489



4x
6210385



4x
6195371

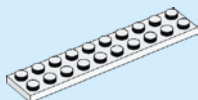

1x
383201



2x
6395748



2x
6046922



4x
4118866



4x
4185177



4x
6294227



2x
4504381



2x
4550348



1x
6092583



2x
6029947



2x
6126050



4x
6079007



2x
302224



2x
302124



1x
6172383



1x
403226



1x
300426



1x
6194233



1x
6405622



2x
6413056



2x
6182261



1x
6389695



2x
6141590



2x
6104342



5x
6186009



2x
4570877



2x
4614158



1x
6104344



2x
6359717

74



1x
4504371



5x
6268818

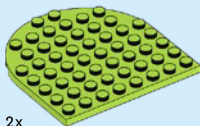

2x
6252480



2x
6132767



1x
6357747



1x
6453246



6x
4216581



4x
6284586



2x
6238874



1x
6133765



2x
6035291



2x
6092590



6x
4629736



1x
4211149



3x
6069984



1x
6338135



1x
6236915



1x
6383143



2x
4211257



1x
6322211



3x
6186577



2x
6430292



2x
4211225



1x
4211387



1x
6344022



8x
6314192



2x
4211054



1x
6344820



1x
4211085



2x
6132422



6x
6212501



1x
4599538



2x
4580010



1x
6296498



1x
6345302



1x
6347306



1x
6167700



1x
6174192



2x
6093494



1x
6398468



[LEGO.com/service](https://www.LEGO.com/service)

YOU COULD
WIN



Scan this QR code or go to
LEGO.COM/PRODUCTFEEDBACK and give us
your short feedback about this LEGO® set
for a chance to win a cool LEGO prize.

Terms and Conditions apply*

EN: YOU COULD WIN. Terms and Conditions apply* **DE: Du könntest GEWINNEN.** Es gelten die Teilnahmebedingungen* **FR: Tu pourrais GAGNER.** Des conditions s'appliquent* **IT: Potresti VINCERE tu.** Termini e condizioni sono applicabili* **ES: Puedes GANAR.** Aplican términos y condiciones* **PT: Poderá GANHAR.** Aplicam-se termos e condições* **ZH: 轻松获奖.** 条款和条件适用* **PL: Szansa na WYGRANĄ.** Obowiązują warunki korzystania* **CS: Máte šanci VYHRÁT.** Platí všeobecné smluvní podmínky* **SK: Máte šancu VYHRÁT.** Platia všeobecné zmluvné podmienky* **HU: TE IS NYERHETSZ.** Felhasználási feltételek érvényesek* **RO: Ai putea CÂȘTIGA.** Se aplică termenii și condiții* **BG: Можете да СПЕЧЕЛИТЕ.** Има определени правила и условия* **LV: Tu vari LAIMĒT.** Ir spēkā noteikumi un nosacījumi.* **ET: Sul on võimalus VÕITA.** Kehtivad tingimused* **LT: Jūs galite LAIMĖTI.** Taikomos sąlygos*

*[LEGO.com/productfeedback-terms](https://www.lego.com/productfeedback-terms)

LEGO and the LEGO logo are trademarks of the/son des marques de commerce du/
son marcas registradas de LEGO Group. ©2024 The LEGO Group.

6490220