

# Vostro 3030 Desktop

## Owner's Manual

## Notes, cautions, and warnings

 **NOTE:** A NOTE indicates important information that helps you make better use of your product.

 **CAUTION:** A CAUTION indicates either potential damage to hardware or loss of data and tells you how to avoid the problem.

 **WARNING:** A WARNING indicates a potential for property damage, personal injury, or death.

<b>Chapter 1: Views of Vostro 3030 Desktop.....</b>	<b>6</b>
Front.....	6
Back.....	7
Service Tag.....	8
<b>Chapter 2: Set up your Vostro 3030 Desktop.....</b>	<b>10</b>
<b>Chapter 3: Specifications of Vostro 3030 Desktop.....</b>	<b>14</b>
Dimensions and weight.....	14
Processor.....	14
Chipset.....	16
Operating system.....	16
Memory.....	16
Memory matrix.....	17
Ports and connectors.....	17
Ethernet.....	18
Wireless module.....	18
Storage.....	19
GPU—Integrated.....	19
GPU—Discrete.....	20
Multiple display support matrix.....	20
Audio.....	20
Power ratings.....	21
Hardware security.....	21
Energy Star and Trusted Platform Module (TPM).....	22
Regulatory compliance.....	22
Operating and storage environment.....	22
Dell support policies.....	23
<b>Chapter 4: Working inside your computer.....</b>	<b>24</b>
Safety instructions.....	24
Before working inside your computer.....	24
Safety precautions.....	25
Electrostatic discharge—ESD protection.....	25
ESD field service kit .....	26
Transporting sensitive components.....	27
After working inside your computer.....	27
BitLocker.....	27
Recommended tools.....	27
Screw list.....	28
Major components of Vostro 3030 Desktop.....	28
<b>Chapter 5: Removing and installing Customer Replaceable Units (CRUs).....</b>	<b>31</b>
Left-side cover.....	31

Removing the left-side cover.....	31
Installing the left-side cover.....	32
Front cover.....	33
Removing the front cover.....	33
Installing the front cover.....	34
Memory.....	35
Removing the memory.....	35
Installing the memory.....	36
Solid-state drive.....	37
Removing the solid-state drive.....	37
Installing the solid-state drive.....	38
Coin-cell battery.....	40
Removing the coin-cell battery.....	40
Installing the coin-cell battery.....	40
Wireless card.....	41
Removing the wireless card.....	41
Installing the wireless card.....	42
Graphics card.....	44
Removing the graphics card.....	44
Installing the graphics card.....	45
Hard drive.....	47
Removing the hard drive.....	47
Installing the hard drive.....	48
Power button.....	49
Removing the power button.....	49
Installing the power button.....	50
Optical drive.....	51
Removing the optical drive.....	51
Installing the optical drive.....	52
Optical-drive bezel.....	53
Removing the optical-drive bezel.....	53
Installing the optical-drive bezel.....	54
Fan shroud.....	55
Removing the fan shroud.....	55
Installing the fan shroud.....	56
Media-card reader.....	57
Removing the media-card reader.....	57
Installing the media-card reader.....	58
Power-supply unit.....	60
Removing the power-supply unit.....	60
Installing the power-supply unit.....	61
<b>Chapter 6: Removing and installing Field Replaceable Units (FRUs).....</b>	<b>64</b>
Antenna modules.....	64
Removing the antenna modules.....	64
Installing the antenna modules.....	65
Processor fan and heat-sink assembly.....	67
Removing the processor fan and heat-sink assembly.....	67
Installing the processor fan and heat-sink assembly.....	68
Processor.....	69

Removing the processor.....	69
Installing the processor.....	70
Optional Input/Output modules.....	71
Serial module.....	71
VGA module.....	72
System board.....	74
Removing the system board.....	74
Installing the system board.....	78
<b>Chapter 7: Software.....</b>	<b>83</b>
Operating system.....	83
Drivers and downloads.....	83
<b>Chapter 8: BIOS Setup.....</b>	<b>84</b>
Entering BIOS setup program.....	84
Navigation keys.....	84
Boot sequence.....	84
F12 One Time Boot menu.....	85
System setup options.....	85
System and setup password.....	100
Assigning a System Setup password.....	100
Deleting or changing an existing system setup password.....	101
Real Time Clock (RTC) reset.....	101
Clearing BIOS (System Setup) and System passwords.....	102
Updating the BIOS.....	102
Updating the BIOS in Windows.....	102
Updating the BIOS using the USB drive in Windows.....	103
Updating the BIOS from the F12 One Time Boot menu.....	103
<b>Chapter 9: Troubleshooting.....</b>	<b>104</b>
<b>Locate the Service Tag or Express Service Code of your Dell computer .....</b>	<b>104</b>
SupportAssist diagnostics.....	104
System diagnostic lights.....	104
Recovering the operating system.....	105
Wi-Fi power cycle.....	105
Drain residual flea power (perform hard reset).....	106
<b>Chapter 10: Getting help and contacting Dell.....</b>	<b>107</b>

# Views of Vostro 3030 Desktop

## Front

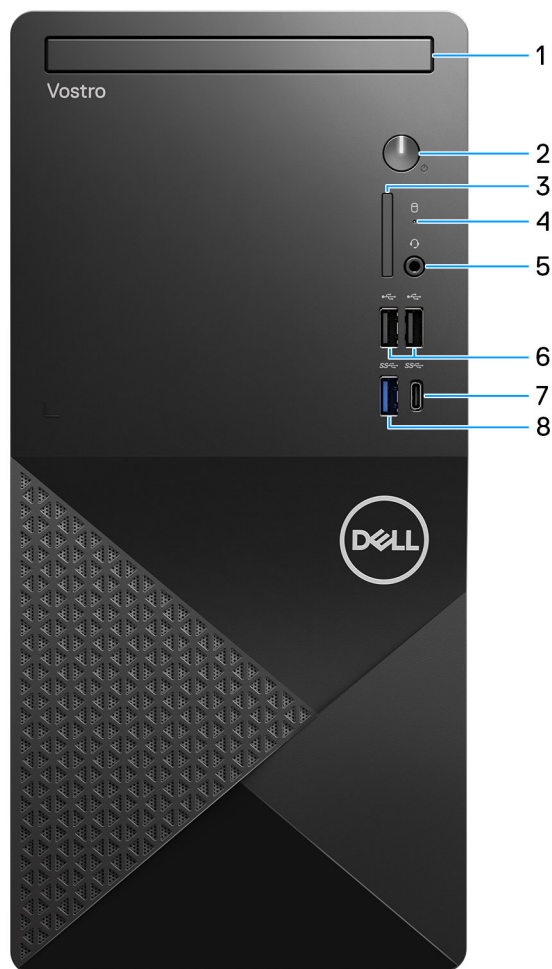

Figure 1. Front view

### 1. Slim optical drive (optional)

The optical drive reads from and writes to CDs and DVDs.

### 2. Power button

Press to turn on the computer if it is turned off, in sleep state, or in hibernate state.

Press to put the computer in sleep state if it is turned on.

Press and hold to force shut-down the computer.

**NOTE:** You can customize the power-button behavior in Windows.

### 3. SD-card slot (optional)

Reads from and writes to the SD card. The computer supports the following card types:

- Secure Digital (SD)

- Secure Digital High Capacity (SDHC)
- Secure Digital Extended Capacity (SDXC)

**4. Hard-drive activity light**

The activity light turns on when the computer reads from or writes to the hard drive.

**5. Global headset jack**

Connect headphones or a headset (headphone and microphone combo).

**6. Two USB 2.0 (480 Mbps) ports**

Connect devices such as external storage devices and printers. Provides data transfer speeds up to 480 Mbps.

**7. One USB 3.2 Type-C Gen 1 (5 Gbps) port**

Connect devices such as external storage devices and printers. Provides data transfer speeds up to 5 Gbps.

**8. One USB 3.2 Gen 1 (5 Gbps) port**

Connect devices such as external storage devices and printers. Provides data transfer speeds up to 5 Gbps.

## Back

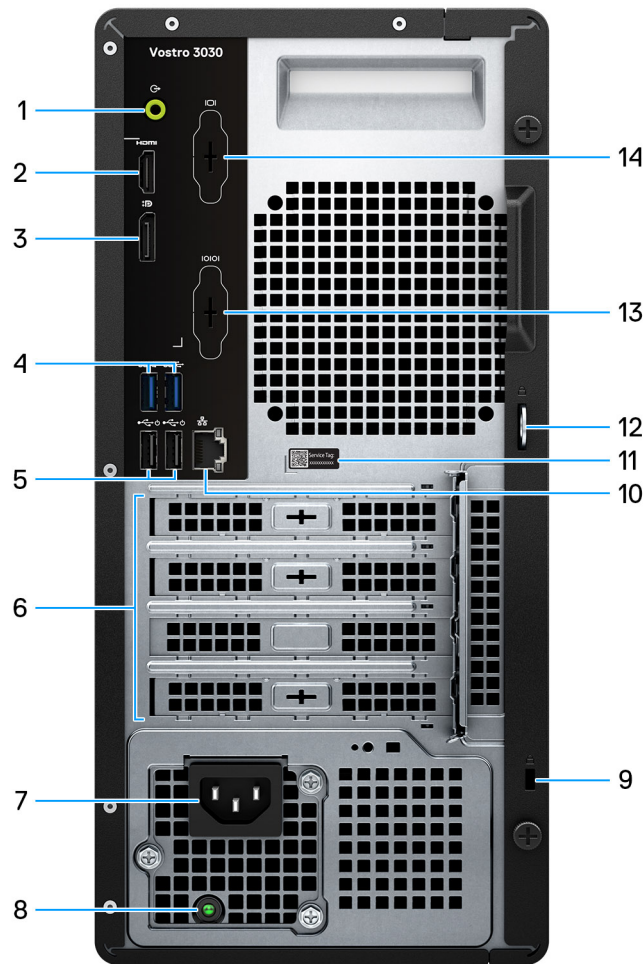

**Figure 2. Back view**

**1. Line-out port**

Connect speakers.

## 2. HDMI 1.4b port

Connect to a TV, external display, or another HDMI-in enabled device. Provides video and audio output.

 **NOTE:** The maximum resolution that is supported by the HDMI 1.4b port is 1920 x 1200 @ 60 Hz.

## 3. DisplayPort 1.4 port

Connect an external display or a projector.

## 4. Two USB 3.2 Gen 1 (5 Gbps) ports

Connect devices such as external storage devices and printers. Provides data transfer speeds up to 5 Gbps.

## 5. Two USB 2.0 (480 Mbps) ports with SmartPower on

Connect devices such as external storage devices and printers. Provides data transfer speeds up to 480 Mbps. Wake from standby with the keyboard or mouse that is connected to this port.

## 6. PCI-Express expansion card slots

Connect a PCI-express card such as an audio or network card to enhance the capabilities of your computer.

## 7. Power cable connector

Connect a power cable to provide power to your computer.

## 8. Power-supply diagnostics light

Indicates the power-supply state.

## 9. Security-cable slot

Connect a security cable to prevent unauthorized movement of your computer.

## 10. Network port

Connect an Ethernet (RJ45) cable from a router or a broadband modem for network or Internet access.

## 11. Service Tag label

The Service Tag is a unique alphanumeric identifier that enables Dell service technicians to identify the hardware components in your computer and access warranty information.

## 12. Padlock rings

Attach a standard padlock to prevent unauthorized access to the interior of your computer.

## 13. Serial port (optional)

Connect a printer.

## 14. VGA port (optional)

Connect an external display or a projector.

# Service Tag

The service tag is a unique alphanumeric identifier that allows Dell service technicians to identify the hardware components in your computer and access warranty information.



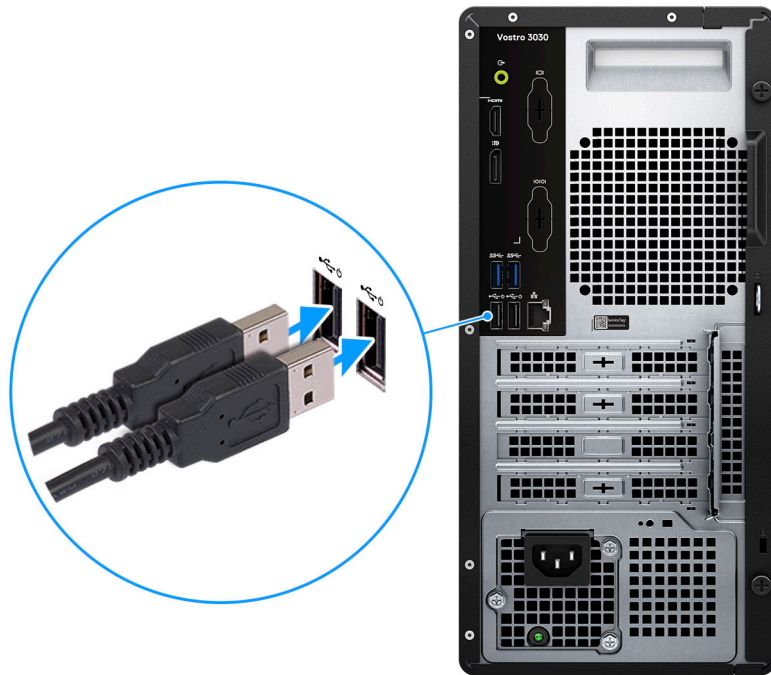

Figure 3. Service Tag location

# Set up your Vostro 3030 Desktop

## Steps

1. Connect the keyboard and mouse.



**Figure 4. Connect the keyboard and mouse**

2. Connect to your network using a cable, or connect to a wireless network.

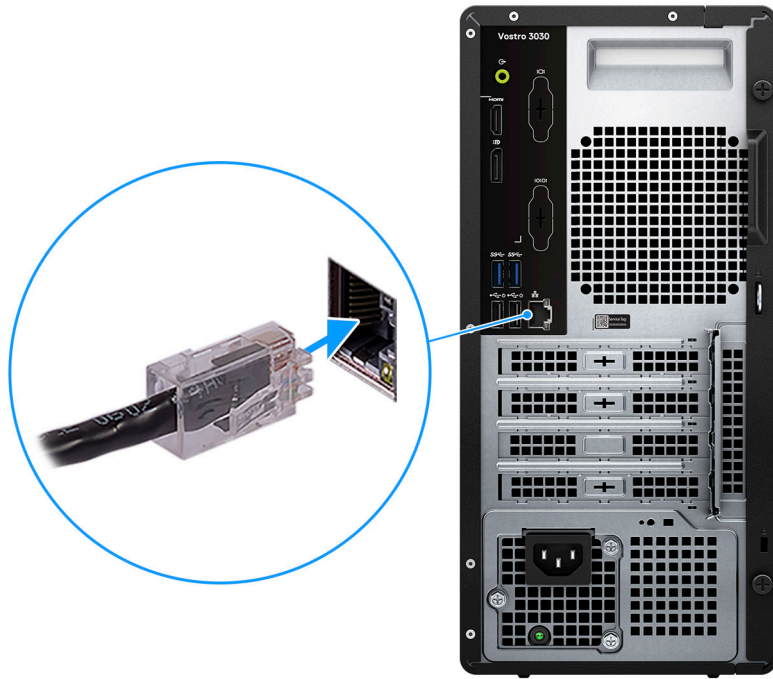

**Figure 5. Connect to your network**

3. Connect the display.



**Figure 6. Connect the display**

4. Connect the power cable.

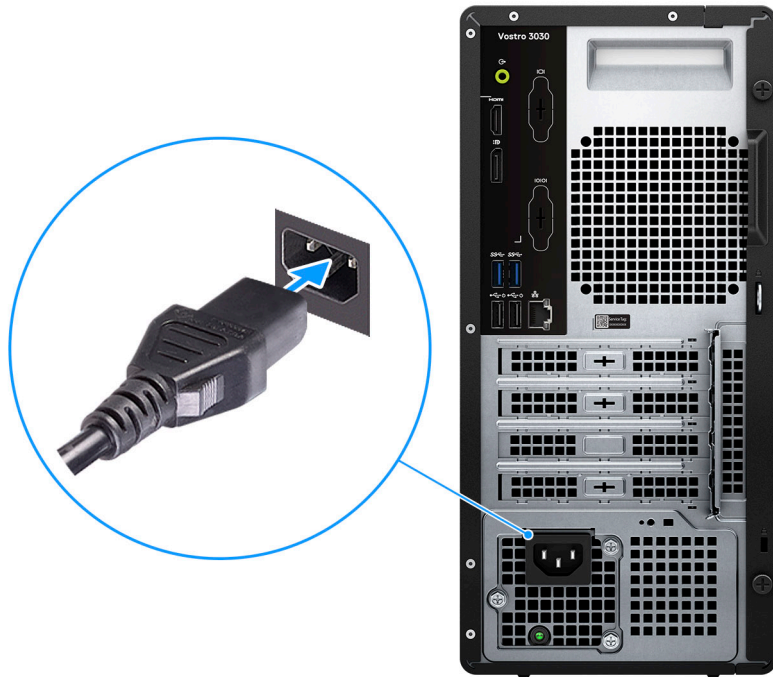

**Figure 7. Connect the power cable**

5. Press the power button.



**Figure 8. Press the power button**

6. Finish the operating system setup.

**For Ubuntu:**

Follow the on-screen instructions to complete the setup. For more information about installing and configuring Ubuntu, search in the Knowledge Base Resource at [www.dell.com/support](http://www.dell.com/support).





**For Windows:**

Follow the on-screen instructions to complete the setup. When setting up, Dell recommends that you:

- Connect to a network for Windows updates.
  - **NOTE:** If connecting to a secured wireless network, enter the password for the wireless network access when prompted.
- If connected to the internet, sign-in with or create a Microsoft account. If not connected to the internet, create an offline account.
- On the **Support and Protection** screen, enter your contact details.

7. Locate and use Dell apps from the Windows Start menu—Recommended

**Table 1. Locate Dell apps**

Resources	Description
	<p><b>MyDell</b></p> <p>MyDell is a software application that offers you a single streamlined engagement platform including account access, device information, and hardware settings. This software delivers intelligent features that automatically fine-tune your computer for the best possible audio, power, and performance. Get the most out of your Dell device with intelligent, personalized technology from MyDell. Following are the key features of MyDell:</p> <ul style="list-style-type: none"> <li>• Application</li> <li>• Audio</li> <li>• Power</li> <li>• Color and Display</li> <li>• Presence detection</li> </ul> <p>For more information about how to use MyDell, see product guides at <a href="http://www.dell.com/support">www.dell.com/support</a>.</p>
	<p><b>SupportAssist</b></p> <p>SupportAssist proactively and predictively identifies hardware and software issues on your computer and automates the engagement process with Dell Technical support. It addresses performance and stabilization issues, prevents security threats, monitors, and detects hardware failures. For more information, see <i>SupportAssist for Home PCs User's Guide</i> at <a href="http://www.dell.com/support/home/product-support/product/dell-supportassist-pcs-tablets/docs">www.dell.com/support/home/product-support/product/dell-supportassist-pcs-tablets/docs</a>.</p> <p><b>NOTE:</b> In SupportAssist, click the warranty expiry date to renew or upgrade your warranty.</p>
	<p><b>Dell Update</b></p> <p>Updates your computer with critical fixes and latest device drivers as they become available. For more information about using Dell Update, see the product guides and third-party license documents at <a href="http://www.dell.com/support">www.dell.com/support</a>.</p>
	<p><b>Dell Digital Delivery</b></p> <p>Download software applications, which are purchased but not preinstalled on your computer. For more information about using Dell Digital Delivery, search in the Knowledge Base Resource at <a href="http://www.dell.com/support">www.dell.com/support</a>.</p>

# Specifications of Vostro 3030 Desktop

## Dimensions and weight

The following table lists the height, width, depth, and weight of your Vostro 3030 Desktop.

**Table 2. Dimensions and weight**

Description	Values
Height	324.30 mm (12.77 in.)
Width	154 mm (6.06 in.)
Depth	292 mm (11.50 in.)
Weight  <b>NOTE:</b> The weight of your computer depends on the configuration ordered and manufacturing variability.	7.27 kg (16.03 lb), maximum

## Processor

The following table lists the details of the processors that are supported by your Vostro 3030 Desktop.

**Table 3. Processor**

Description	Option one	Option two	Option three	Option four	Option five	Option six
Processor type	14 <sup>th</sup> Generation Intel Core i3-14100	14 <sup>th</sup> Generation Intel Core i5-14400	14 <sup>th</sup> Generation Intel Core i5-14400F	14 <sup>th</sup> Generation Intel Core i7-14700	14 <sup>th</sup> Generation Intel Core i7-14700F	Intel 300
Processor wattage	65 W	65 W	65 W	65 W	65 W	46 W
Processor total core count	4	10	10	20	20	2
Performance-cores	4	6	6	8	8	2
Efficient-cores	Not applicable	4	4	12	12	Not applicable
Processor total thread counts	8	16	16	28	28	4
<b>i</b> NOTE: Intel Hyper-Threading Technology is only available on Performance-cores.						
Processor speed	Up to 4.70 GHz	Up to 4.70 GHz	Up to 4.70 GHz	Up to 5.30 GHz	Up to 5.30 GHz	Up to 3.90 GHz
Performance-cores frequency						
Processor base frequency	3.50 GHz	2.50 GHz	2.50 GHz	2.10 GHz	2.10 GHz	Not applicable
Maximum turbo frequency	4.70 GHz	4.70 GHz	4.70 GHz	5.40 GHz	5.40 GHz	Not applicable
Efficient-cores frequency						
Processor base frequency	Not applicable	1.80 GHz	1.80 GHz	1.50 GHz	1.50 GHz	Not applicable
Maximum turbo frequency	Not applicable	3.50 GHz	3.50 GHz	4.20 GHz	4.20 GHz	Not applicable
Processor cache	12 MB	20 MB	20 MB	33 MB	33 MB	6 MB
Integrated graphics	Intel UHD Graphics 730	Intel UHD Graphics 730	None	Intel UHD Graphics 770	None	Intel UHD 710 Graphics

# Chipset

The following table lists the details of the chipset that is supported for your Vostro 3030 Desktop.

**Table 4. Chipset**

Description	Values
Chipset	B660
Processor	<ul style="list-style-type: none"><li>14<sup>th</sup> Generation Intel Core i3/i5/i5F/i7/i7F</li><li>Intel 300</li></ul>
DRAM bus width	64-bit
Flash EPROM	32 MB
PCIe bus	Up to Gen 3.0

# Operating system

Your Vostro 3030 Desktop supports the following operating systems:

- Windows 11 Home
- Windows 11 Pro
- Windows 11 Home National Education
- Windows 11 Pro National Education
- Ubuntu 22.04 LTS

# Memory

The following table lists the memory specifications of your Vostro 3030 Desktop.

**Table 5. Memory specifications**

Description	Values
Memory slots	Two U-DIMM slots
Memory type	DDR5
Memory speed	<ul style="list-style-type: none"><li>5600 MT/s</li><li>4800 MT/s</li></ul>
Maximum memory configuration	64 GB
Minimum memory configuration	8 GB
Memory size per slot	8 GB, 16 GB and 32 GB
Memory configurations supported	<b>For computers shipped with a 14th Gen Intel Core i7 processor:</b> <ul style="list-style-type: none"><li>8 GB: 1 x 8 GB, DDR5, 5600 MT/s, single-channel</li><li>16 GB: 1 x 16 GB, DDR5, 5600 MT/s, single-channel</li><li>16 GB: 2 x 8 GB, DDR5, 5600 MT/s, dual-channel</li><li>32 GB: 1 x 32 GB, DDR5, 5600 MT/s, single-channel</li><li>32 GB: 2 x 16 GB, DDR5, 5600 MT/s, dual-channel</li></ul>



**Table 5. Memory specifications (continued)**

Description	Values
	<ul style="list-style-type: none"> <li>64 GB: 2 x 32 GB, DDR5, 5600 MT/s, dual-channel</li> </ul> <p><b>For computers shipped with a 14th Gen Intel Core i3/i5 or Intel 300 processor:</b></p> <ul style="list-style-type: none"> <li>8 GB: 1 x 8 GB, DDR5, 4800 MT/s, single-channel</li> <li>16 GB: 1 x 16 GB, DDR5, 4800 MT/s, single-channel</li> <li>16 GB: 2 x 8 GB, DDR5, 4800 MT/s, dual-channel</li> <li>32 GB: 1 x 32 GB, DDR5, 4800 MT/s, single-channel</li> <li>32 GB: 2 x 16 GB, DDR5, 4800 MT/s, dual-channel</li> <li>64 GB: 2 x 32 GB, DDR5, 4800 MT/s, dual-channel</li> </ul>

## Memory matrix

The following table lists the memory configurations supported on your Vostro 3030 Desktop.

**Table 6. Memory matrix**

Configuration	Slot	
	U-DIMM1	U-DIMM2
8 GB DDR5	8 GB	
16 GB DDR5	16 GB	
16 GB DDR5	8 GB	8 GB
32 GB DDR5	32 GB	
32 GB DDR5	16 GB	16 GB
64 GB DDR5	32 GB	32 GB

## Ports and connectors

The following table lists the external and internal ports available on your Vostro 3030 Desktop.

**Table 7. Ports and connectors**

Description	Values
<b>External:</b>	
Network	One RJ45 Ethernet port
USB	<ul style="list-style-type: none"> <li>One USB 3.2 Gen 1 (5 Gbps) port</li> <li>One USB 3.2 Gen 1 (5 Gbps) Type-C port</li> <li>Two USB 2.0 (480 Mbps) ports</li> <li>Two USB 3.2 Gen 1 (5 Gbps) ports</li> <li>Two USB 2.0 (480 Mbps) ports with SmartPower On</li> </ul>
Audio	<ul style="list-style-type: none"> <li>One global headset jack</li> <li>One audio line-out port</li> </ul>
Video	<ul style="list-style-type: none"> <li>One DisplayPort 1.4a port</li> <li>One HDMI 1.4b port (1920 x 1200 @ 60 Hz max resolution)</li> </ul>
Media-card reader	One SD-card slot (optional)

**Table 7. Ports and connectors (continued)**

Description	Values
Power port	One AC power-supply port
Security	<ul style="list-style-type: none"> <li>One padlock ring slot</li> <li>One security-cable slot (wedge-shaped)</li> </ul>
<b>Internal:</b>	
PCIe expansion card slots	<ul style="list-style-type: none"> <li>One PCIe x16 full-height expansion card slot</li> <li>Two PCIe x1 full-height slot</li> </ul>
mSATA	None
SATA	<ul style="list-style-type: none"> <li>Two SATA 3.0 slots for 3.5-inch hard drives</li> <li>One SATA 2.0 slot for the optional slim optical drive</li> </ul>
M.2	<ul style="list-style-type: none"> <li>One M.2 2230 slot for WiFi and Bluetooth combo card</li> <li>One M.2 2230/2280 slot for solid-state drive</li> </ul> <p><b>NOTE:</b> To learn more about the features of different types of M.2 cards, search in the Knowledge Base Resource at <a href="http://www.dell.com/support">www.dell.com/support</a>.</p>

## Ethernet

The following table lists the wired Ethernet Local Area Network (LAN) specifications of your Vostro 3030 Desktop.

**Table 8. Ethernet specifications**

Description	Values
Model number	Realtek RTL8111HD
Transfer rate	10/100/1000 Mbps

## Wireless module

The following table lists the Wireless Local Area Network (WLAN) modules that are supported on your Vostro 3030 Desktop.

**Table 9. Wireless module specifications**

Description	Option one	Option two
Model number	Realtek RTL8852BE	Intel AX211
Transfer rate	Up to 1201 Mbps	Up to 2400 Mbps
Frequency bands supported	2.4 GHz/5 GHz	2.4 GHz/ 5 GHz/ 6 GHz
Wireless standards	<ul style="list-style-type: none"> <li>WiFi 802.11a/b/g</li> <li>Wi-Fi 4 (WiFi 802.11n)</li> <li>Wi-Fi 5 (WiFi 802.11ac)</li> </ul>	<ul style="list-style-type: none"> <li>WiFi 802.11a/b/g</li> <li>Wi-Fi 4 (WiFi 802.11n)</li> <li>Wi-Fi 5 (WiFi 802.11ac)</li> <li>Wi-Fi 6E (WiFi 802.11ax)</li> </ul>
Encryption	<ul style="list-style-type: none"> <li>64-bit/128-bit WEP</li> <li>AES-CCMP</li> </ul>	<ul style="list-style-type: none"> <li>64-bit/128-bit WEP</li> <li>AES-CCMP</li> </ul>

**Table 9. Wireless module specifications (continued)**

Description	Option one	Option two
	<ul style="list-style-type: none"> <li>TKIP</li> </ul>	<ul style="list-style-type: none"> <li>TKIP</li> </ul>
Bluetooth wireless card	Bluetooth 5.3	Bluetooth 5.3
	<p><b>NOTE:</b> The version of the Bluetooth wireless card may vary depending on the operating system that is installed on your computer.</p>	

## Storage

This section lists the storage options on your Vostro 3030 Desktop.

Your Vostro 3030 supports one of the following storage configurations:

- One 3.5-inch hard drive
- One 3.5-inch hard drive + one M.2 2230/2280 solid-state drive
- One M.2 2230/2280 solid-state drive

The primary drive of your Vostro 3030 varies with the storage configuration. For computers:

- With a M.2 solid-state drive, the M.2 solid-state drive is the primary drive

**Table 10. Storage specifications**

Storage type	Interface type	Capacity
3.5-inch hard drive, 7200 RPM	SATA AHCI, up to 6 Gbps	Up to 2 TB
M.2 2230 solid-state drive	PCIe NVMe, up to 32 Gbps	Up to 1 TB
M.2 2230 solid-state drive	PCIe NVMe, up to 32 Gbps	Up to 1 TB
M.2 2280 solid-state drive, QLC	PCIe NVMe, up to 32 Gbps. QLC	Up to 1 TB
9.5 mm 16x slimline DVD-RW drive	SATA AHCI, up to 1.5 Gbps	One DVD-RW

## GPU—Integrated

The following table lists the specifications of the integrated Graphics Processing Unit (GPU) supported by your Vostro 3030 Desktop.

**Table 11. GPU—Integrated**

Controller	External display support	Memory size	Processor
Intel UHD 710 Graphics	<ul style="list-style-type: none"> <li>One DisplayPort 1.4a</li> <li>One HDMI 1.4b</li> </ul>	Shared system memory	Intel 300
Intel UHD 730 Graphics	<ul style="list-style-type: none"> <li>One DisplayPort 1.4a</li> <li>One HDMI 1.4b</li> </ul>	Shared system memory	14th Generation Intel Core i3/i5
Intel UHD 770 Graphics	<ul style="list-style-type: none"> <li>One DisplayPort 1.4a</li> <li>One HDMI 1.4b</li> </ul>	Shared system memory	14th Generation Intel Core i7
<p><b>NOTE:</b> Intel UHD Graphics is not available for computers that are shipped with 14th Generation Intel Core i5-14400F and 14th Generation Intel Core i7-14700F processors.</p>			

## GPU—Discrete

The following table lists the specifications of the discrete Graphics Processing Unit (GPU) supported by your Vostro 3030 Desktop.

**Table 12. GPU—Discrete**

Controller	External display support	Memory size	Memory type
NVIDIA RTX 3050	<ul style="list-style-type: none"> <li>Three DisplayPort 1.4a ports</li> <li>One HDMI 2.1 port</li> </ul>	8 GB	GDDR6
NVIDIA RTX 4060	<ul style="list-style-type: none"> <li>Three DisplayPort 1.4a ports</li> <li>One HDMI 2.1a port</li> </ul>	8 GB	GDDR6

## Multiple display support matrix

**Table 13. Integrated graphics card**

Graphics Card	Intel UHD Graphics
Video ports on Integrated Graphics Card	<ul style="list-style-type: none"> <li>One DisplayPort 1.4a</li> <li>One HDMI 1.4b</li> </ul>
Number of displays supported	2

**Table 14. Discrete graphics card**

Graphics Card	NVIDIA RTX 3050	NVIDIA RTX 4060
Memory	8 GB GDDR6	8 GB GDDR6
Video Ports	<ul style="list-style-type: none"> <li>Three DisplayPort 1.4a ports</li> <li>One HDMI 2.1 port</li> </ul>	<ul style="list-style-type: none"> <li>Three DisplayPort 1.4a ports</li> <li>One HDMI 2.1a port</li> </ul>
Maximum displays supported (direct connection)	4	4
DisplayPort Multi-Stream Transport (MST) support	Supported	Supported
Total Power	120W	115W

**NOTE:** DisplayPort Multi-Stream Transport (MST) allows you to daisy chain monitors that have DisplayPort 1.2 and above ports and MST support. For more information about this feature and how to set it up on your computer please refer to the following Knowledge Base article [How to Daisy Chain Multiple Monitors Using DisplayPort Multi-Stream Transport \(MST\)](#)

## Audio

The following table lists the audio specifications of your Vostro 3030 Desktop.

**Table 15. Audio specifications**

Description	Values
Audio type	Integrated 5.1 Channel High Definition audio
Audio controller	Cirrus Logic CS8409 + CS42L42

**Table 15. Audio specifications (continued)**

Description	Values
Internal audio interface	High definition audio interface
External audio interface	<ul style="list-style-type: none"> <li>One global headset jack</li> <li>One audio line-out port</li> </ul>

## Power ratings

The following table lists the power rating specifications of Vostro 3030 Desktop.

**Table 16. Power ratings**

Description	Option one	Option two	Option three
Type	180 W internal Power Supply Unit (PSU), 85% Efficient, 80 PLUS Bronze	300 W internal Power Supply Unit (PSU), 85% Efficient, 80 PLUS Bronze	460 W internal Power Supply Unit (PSU), 85% Efficient, 80 PLUS Bronze
Input voltage	90 VAC–264 VAC	90 VAC–264 VAC	90 VAC–264 VAC
Input frequency	47 Hz–63 Hz	47 Hz–63 Hz	47 Hz–63 Hz
Input current (maximum)	3 A	4.6 A	7 A
Output current (continuous)	Operating: <ul style="list-style-type: none"> <li>12 VA - 15 A</li> <li>12 VB – 14 A</li> </ul> Standby: <ul style="list-style-type: none"> <li>12 VA - 1.50 A</li> <li>12 VB – 3.30 A</li> </ul>	Operating: <ul style="list-style-type: none"> <li>12 VA - 16.50 A</li> <li>12 VB – 15 A</li> <li>12 VC – 12 A</li> </ul> Standby: <ul style="list-style-type: none"> <li>12 VA - 1.50 A</li> <li>12 VB – 3.30 A</li> <li>12 VC – 0 A</li> </ul>	Operating: <ul style="list-style-type: none"> <li>12 VA1 - 18.0 A</li> <li>12 VA2 - 18.0 A</li> <li>12 VB – 18.0 A</li> <li>12 VC – 18.0 A</li> </ul> Standby: <ul style="list-style-type: none"> <li>12 VA - 1.50 A</li> <li>12 VB – 3.30 A</li> <li>12 VC – 0 A</li> </ul>
Rated output voltage	<ul style="list-style-type: none"> <li>12 VA</li> <li>12 VB</li> </ul>	<ul style="list-style-type: none"> <li>12 VA</li> <li>12 VB</li> <li>12 VC</li> </ul>	<ul style="list-style-type: none"> <li>12 VA</li> <li>12 VB</li> <li>12 VC</li> </ul>
Temperature range:			
Operating	5°C to 45°C (41°F to 113°F)	5°C to 45°C (41°F to 113°F)	5°C to 45°C (41°F to 113°F)
Storage	-40°C to 70°C (-40°F to 158°F)	-40°C to 70°C (-40°F to 158°F)	-40°C to 70°C (-40°F to 158°F)

## Hardware security

**Table 17. Hardware security options**

Hardware security options
Kensington lock slot
Padlock ring
Local hard drive data wipe through BIOS (Secure Erase)

**Table 17. Hardware security options (continued)**

Hardware security options
Microsoft Windows Bitlocker
BIOS Data Port On/Off - Data port disablement
Firmware Trusted Platform Module (TPM) 2.0

## Energy Star and Trusted Platform Module (TPM)

**Table 18. Energy Star and TPM**

Features	Specifications
Energy Star 8.0	Compliant configurations available
Firmware-TPM (Discrete TPM disabled)	Optional

 **NOTE:** TPM is not available in all countries.

## Regulatory compliance

The following table lists the regulatory compliance of your Vostro 3030 Desktop.

**Table 19. Regulatory compliance**

Regulatory compliance
EPEAT registered configurations available
ENERGY STAR compliant configurations available
CEL
WEEE
South Korea E-standby
EU RoHS
China RoHS

## Operating and storage environment

This table lists the operating and storage specifications of your Vostro 3030 Desktop.

**Airborne contaminant level:** G1 as defined by ISA-S71.04-1985

**Table 20. Computer environment**

Description	Operating	Storage
Temperature range	0°C to 35°C (32°F to 95°F)	-40°C to 65°C (-40°F to 149°F)
Relative humidity (maximum)	10% to 90% (non-condensing)	0% to 95% (non-condensing)
Vibration (maximum)*	0.66 GRMS	1.30 GRMS
Shock (maximum)	110 G†	160 G†

**Table 20. Computer environment (continued)**

Description	Operating	Storage
Altitude range	-15.2 m to 3048 m (-49.87 ft to 10000 ft)	-15.2 m to 10668 m (-49.87 ft to 35000 ft)

 **CAUTION:** Operating and storage temperature ranges may differ among components, so operating or storing the device outside these ranges may impact the performance of specific components.

\* Measured using a random vibration spectrum that simulates user environment.

† Measured using a 2 ms half-sine pulse when the hard drive is in use.











## Dell support policies

For more information on support policy, see the knowledge base articles [000181418](#), [000043920](#), and [000181188](#).

# Working inside your computer

## Safety instructions

Use the following safety guidelines to protect your computer from potential damage and to ensure your personal safety. Unless otherwise noted, each procedure in this document assumes that you have read the safety information that shipped with your computer.

-  **WARNING:** Before working inside your computer, read the safety information that is shipped with your computer. For more safety best practices, see the Regulatory Compliance home page at [www.dell.com/regulatory\\_compliance](http://www.dell.com/regulatory_compliance).
-  **WARNING:** Disconnect your computer from all power sources before opening the computer cover or panels. After you finish working inside the computer, replace all covers, panels, and screws before connecting your computer to an electrical outlet.
-  **CAUTION:** To avoid damaging the computer, ensure that the work surface is flat, dry, and clean.
-  **CAUTION:** To avoid damaging the components and cards, handle them by their edges, and avoid touching the pins and the contacts.
-  **CAUTION:** You should only perform troubleshooting and repairs as authorized or directed by the Dell technical assistance team. Damage due to servicing that is not authorized by Dell is not covered by your warranty. See the safety instructions that is shipped with the product or at [www.dell.com/regulatory\\_compliance](http://www.dell.com/regulatory_compliance).
-  **CAUTION:** Before touching anything inside your computer, ground yourself by touching an unpainted metal surface, such as the metal at the back of the computer. While you work, periodically touch an unpainted metal surface to dissipate static electricity which could harm internal components.
-  **CAUTION:** When you disconnect a cable, pull it by its connector or its pull tab, not the cable itself. Some cables have connectors with locking tabs or thumbscrews that you must disengage before disconnecting the cable. When disconnecting cables, keep them evenly aligned to avoid bending the connector pins. When connecting cables, ensure that the ports and the connectors are correctly oriented and aligned.
-  **CAUTION:** Press and eject any installed card from the media-card reader.
-  **CAUTION:** Exercise caution when handling rechargeable Li-ion batteries in laptops. Swollen batteries should not be used and should be replaced and disposed properly.
-  **NOTE:** The color of your computer and certain components may appear differently than shown in this document.

## Before working inside your computer

### About this task

-  **NOTE:** The images in this document may differ from your computer depending on the configuration you ordered.

### Steps

1. Save and close all open files and exit all open applications.
2. Shut down your computer. Click **Start** >  **Power** > **Shut down**.



 **NOTE:** If you are using a different operating system, see the documentation of your operating system for shut-down instructions.

3. Disconnect your computer and all attached devices from their electrical outlets.
4. Disconnect all attached network devices and peripherals, such as keyboard, mouse, and monitor from your computer.

 **CAUTION:** To disconnect a network cable, first unplug the cable from your computer and then unplug the cable from the network device.

5. Remove any media card and optical disc from your computer, if applicable.

## Safety precautions

The safety precautions chapter details the primary steps to be taken before performing any disassembly instructions.

Observe the following safety precautions before you perform any installation or break or fix procedures involving disassembly or reassembly:

- Turn off the computer and all attached peripherals.
- Disconnect the computer and all attached peripherals from AC power.
- Disconnect all network cables, telephone, and telecommunications lines from the computer.
- Use an ESD field service kit when working inside any to avoid electrostatic discharge (ESD) damage.
- After removing any computer component, carefully place the removed component on an anti-static mat.
- Wear shoes with non-conductive rubber soles to reduce the chance of getting electrocuted.

## Standby power

Dell products with standby power must be unplugged before you open the case. Systems that incorporate standby power are powered while turned off. The internal power enables the computer to be remotely turned on (Wake-on-LAN) and suspended into a sleep mode and has other advanced power management features.

Unplugging, pressing, and holding the power button for 15 seconds should discharge residual power in the system board.

## Bonding

Bonding is a method for connecting two or more grounding conductors to the same electrical potential. This is done by using a field service electrostatic discharge (ESD) kit. When connecting a bonding wire, ensure that it is connected to bare metal and never to a painted or nonmetal surface. The wrist strap should be secure and in full contact with your skin, and ensure that you remove all jewelry such as watches, bracelets, or rings prior to bonding yourself and the equipment.

## Electrostatic discharge—ESD protection

ESD is a major concern when you handle electronic components, especially sensitive components such as expansion cards, processors, memory DIMMs, and system boards. Slight charges can damage circuits in ways that may not be obvious, such as intermittent problems or a shortened product life span. As the industry pushes for lower power requirements and increased density, ESD protection is an increasing concern.

Due to the increased density of semiconductors used in recent Dell products, the sensitivity to static damage is now higher than in previous Dell products. For this reason, some previously approved methods of handling parts are no longer applicable.

Two recognized types of ESD damage are catastrophic and intermittent failures.

- **Catastrophic** – Catastrophic failures represent approximately 20 percent of ESD-related failures. The damage causes an immediate and complete loss of device functionality. An example of catastrophic failure is a memory DIMM that has received a static shock and immediately generates a "No POST/No Video" symptom with a beep code that is emitted for missing or nonfunctional memory.
- **Intermittent** – Intermittent failures represent approximately 80 percent of ESD-related failures. The high rate of intermittent failures means that most of the time when damage occurs, it is not immediately recognizable. The DIMM receives a static shock, but the tracing is merely weakened and does not immediately produce outward symptoms that are related to the damage. The weakened trace may take weeks or months to melt, and in the meantime may cause degradation of memory integrity, intermittent memory errors, and so on.

The more difficult type of damage to recognize and troubleshoot is the intermittent (also called latent or "walking wounded") failure.

Perform the following steps to prevent ESD damage:

- Use a wired ESD wrist strap that is properly grounded. The use of wireless anti-static straps is no longer allowed; they do not provide adequate protection. Touching the chassis before handling parts does not ensure adequate ESD protection on parts with increased sensitivity to ESD damage.
- Handle all static-sensitive components in a static-safe area. If possible, use anti-static floor pads and workbench pads.
- When unpacking a static-sensitive component from its shipping carton, do not remove the component from the anti-static packing material until you are ready to install the component. Before unwrapping the anti-static packaging, ensure that you discharge static electricity from your body.
- Before transporting a static-sensitive component, place it in an anti-static container or packaging.

## ESD field service kit

The unmonitored Field Service kit is the most commonly used service kit. Each Field Service kit includes three main components: anti-static mat, wrist strap, and bonding wire.

### Components of an ESD field service kit

The components of an ESD field service kit are:

- **Anti-Static Mat** – The anti-static mat is dissipative and parts can be placed on it during service procedures. When using an anti-static mat, your wrist strap should be snug and the bonding wire should be connected to the mat and to any bare metal on the computer being worked on. Once deployed properly, service parts can be removed from the ESD bag and placed directly on the mat. ESD-sensitive items are safe in your hand, on the ESD mat, in the computer, or inside a bag.
- **Wrist Strap and Bonding Wire** – The wrist strap and bonding wire can be either directly connected between your wrist and bare metal on the hardware if the ESD mat is not required, or connected to the anti-static mat to protect hardware that is temporarily placed on the mat. The physical connection of the wrist strap and bonding wire between your skin, the ESD mat, and the hardware is known as bonding. Use only Field Service kits with a wrist strap, mat, and bonding wire. Never use wireless wrist straps. Always be aware that the internal wires of a wrist strap are prone to damage from normal wear and tear, and must be checked regularly with a wrist strap tester in order to avoid accidental ESD hardware damage. It is recommended to test the wrist strap and bonding wire at least once per week.
- **ESD Wrist Strap Tester** – The wires inside an ESD strap are prone to damage over time. When using an unmonitored kit, it is a best practice to regularly test the strap prior to each service call, and at a minimum, test once per week. A wrist strap tester is the best method for doing this test. If you do not have your own wrist strap tester, check with your regional office to find out if they have one. To perform the test, plug the wrist-strap's bonding-wire into the tester while it is strapped to your wrist and push the button to test. A green LED is lit if the test is successful; a red LED is lit and an alarm sounds if the test fails.
- **Insulator Elements** – It is critical to keep ESD sensitive devices, such as plastic heat sink casings, away from internal parts that are insulators and often highly charged.
- **Working Environment** – Before deploying the ESD Field Service kit, assess the situation at the customer location. For example, deploying the kit for a server environment is different than for a desktop or laptop environment. Servers are typically installed in a rack within a data center; desktops or laptops are typically placed on office desks or cubicles. Always look for a large open flat work area that is free of clutter and large enough to deploy the ESD kit with additional space to accommodate the type of computer that is being repaired. The workspace should also be free of insulators that can cause an ESD event. On the work area, insulators such as Styrofoam and other plastics should always be moved at least 12 inches or 30 centimeters away from sensitive parts before physically handling any hardware components.
- **ESD Packaging** – All ESD-sensitive devices must be shipped and received in static-safe packaging. Metal, static-shielded bags are preferred. However, you should always return the damaged part using the same ESD bag and packaging that the new part arrived in. The ESD bag should be folded over and taped shut and all the same foam packing material should be used in the original box that the new part arrived in. ESD-sensitive devices should be removed from packaging only at an ESD-protected work surface, and parts should never be placed on top of the ESD bag because only the inside the bag is shielded. Always place parts in your hand, on the ESD mat, in the computer, or inside an anti-static bag.
- **Transporting Sensitive Components** – When transporting ESD sensitive components such as replacement parts or parts to be returned to Dell, it is critical to place these parts in anti-static bags for safe transport.

## ESD protection summary

It is recommended to use the traditional wired ESD grounding wrist strap and protective anti-static mat always when servicing Dell products. In addition, it is critical to keep sensitive parts separate from all insulator parts while performing service and that they use anti-static bags for transporting sensitive components.

## Transporting sensitive components

When transporting ESD sensitive components such as replacement parts or parts to be returned to Dell, it is critical to place these parts in anti-static bags for safe transport.

## Lifting equipment

Adhere to the following guidelines when lifting heavy weight equipment:

 **CAUTION: Do not lift greater than 50 pounds. Always obtain additional resources or use a mechanical lifting device.**

1. Get a firm balanced footing. Keep your feet apart for a stable base, and point your toes out.
2. Tighten stomach muscles. Abdominal muscles support your spine when you lift, offsetting the force of the load.
3. Lift with your legs, not your back.
4. Keep the load close. The closer it is to your spine, the less force it exerts on your back.
5. Keep your back upright, whether lifting or setting down the load. Do not add the weight of your body to the load. Avoid twisting your body and back.
6. Follow the same techniques in reverse to set the load down.

## After working inside your computer

### About this task

 **CAUTION: Leaving stray or loose screws inside your computer may severely damage your computer.**

### Steps

1. Replace all screws and ensure that no stray screws remain inside your computer.
2. Connect any external devices, peripherals, or cables you removed before working on your computer.
3. Replace any media cards, discs, or any other parts that you removed before working on your computer.
4. Connect your computer and all attached devices to their electrical outlets.
5. Turn on your computer.

## BitLocker

 **CAUTION: If BitLocker is not suspended before updating the BIOS, the next time you reboot the system it will not recognize the BitLocker key. You will then be prompted to enter the recovery key to progress, and the system will ask for this on each reboot. If the recovery key is not known this can result in data loss or an unnecessary operating system reinstall. For more information about this subject, see Knowledge Article: [updating the BIOS on Dell systems with BitLocker enabled](#).**

The installation of the following components triggers BitLocker:

- Hard disk drive or solid-state drive
- System board

## Recommended tools

The procedures in this document may require the following tools:

- Phillips screwdriver #0
- Phillips screwdriver #1
- Plastic scribe











## Screw list

**NOTE:** When removing screws from a component, it is recommended to note the screw type, the quantity of screws, and then place them in a screw storage box. This is to ensure that the correct number of screws and correct screw type is restored when the component is replaced.

**NOTE:** Some computers have magnetic surfaces. Ensure that the screws are not left attached to such surfaces when replacing a component.

**NOTE:** Screw color may vary with the configuration ordered.

**Table 21. Screw list**

Component	Screw type	Quantity	Screw image
Left-side cover	6-32	2	
Solid state drive	M2x3.5	1	
Wireless card	M2x3.5	1	
Hard drive	6-32, pan head	4	
Power-supply unit	#6-32, hex head	3	
Optical drive	M2x2	2	
Media-card reader	6-32, pan head	1	
Front I/O-bracket	6-32, pan head	2	
Processor fan and heat-sink assembly	Captive (M3)	4	
System board	6-32, hex head	8	

## Major components of Vostro 3030 Desktop

The following image shows the major components of Vostro 3030 Desktop.

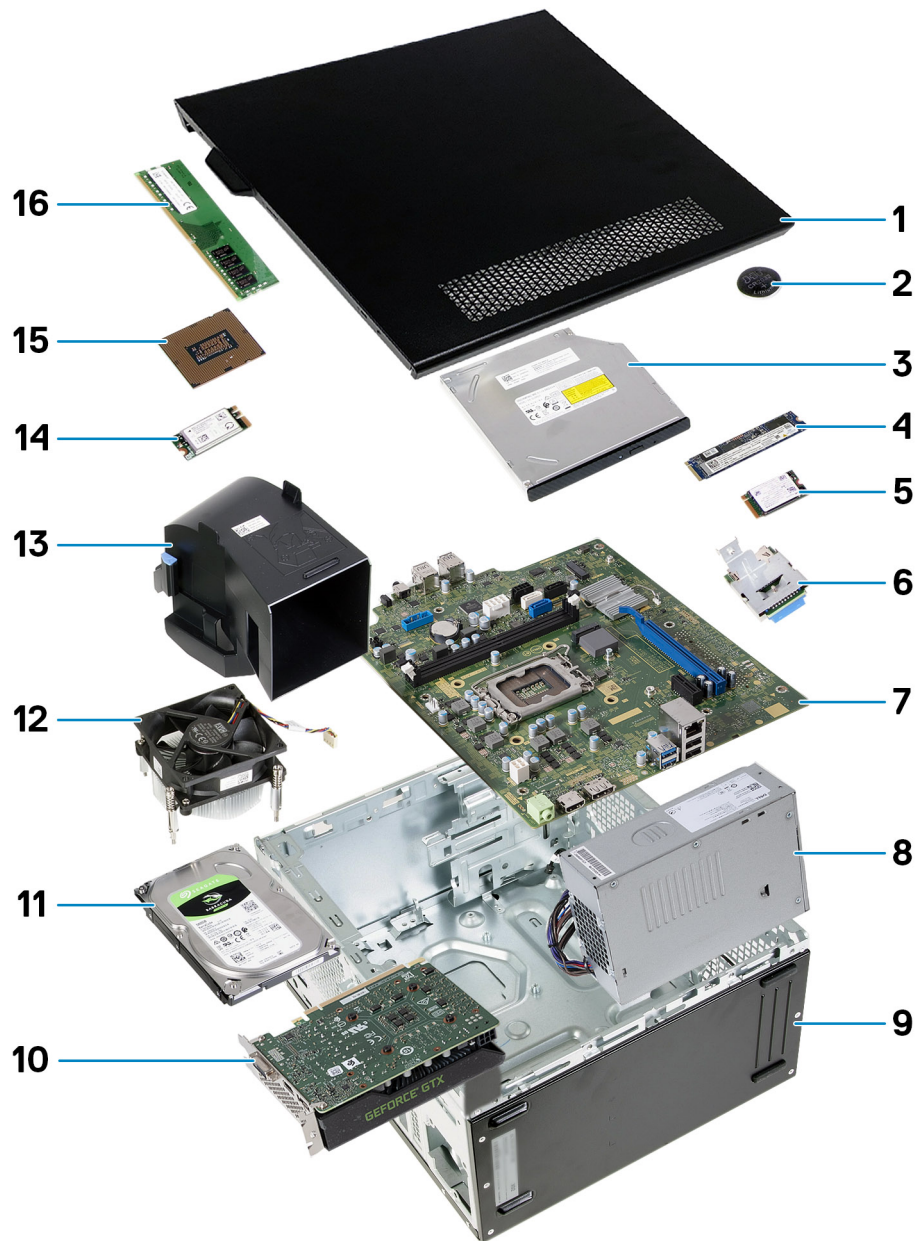

**Figure 9. Major Components of your system**

1. Side cover
2. Coin-cell battery
3. Optical drive
4. M.2 2280 solid state drive
5. M.2 2230 solid state drive
6. Media-card reader
7. System board
8. Power-supply unit
9. Chassis
10. Graphics card
11. Hard drive
12. Processor-fan and heat-sink assembly
13. Fan shroud
14. Wireless card
15. Processor
16. Memory module

 **NOTE:** Dell provides a list of components and their part numbers for the original system configuration purchased. These parts are available according to warranty coverages purchased by the customer. Contact your Dell sales representative for purchase options.

# Removing and installing Customer Replaceable Units (CRUs)

The replaceable components in this chapter are Customer Replaceable Units (CRUs).

**CAUTION:** Customers can replace only the Customer Replaceable Units (CRUs) following the safety precautions and replacement procedures.

**NOTE:** The images in this document may differ from your computer depending on the configuration you ordered.

## Left-side cover

### Removing the left-side cover

#### Prerequisites

1. Follow the procedure in [Before working inside your computer](#).

#### About this task

The following image indicates the location of the left-side cover and provides a visual representation of the removal procedure.



2x  
6-32



**Figure 10. Removing the left-side cover**

#### **Steps**

1. Remove the two screws (6-32) that secure the left-side cover to the chassis.
2. Holding the tab on the left-side cover firmly, slide and remove the left-side cover from the chassis.

## **Installing the left-side cover**

#### **Prerequisites**

If you are replacing a component, remove the existing component before performing the installation process.

#### **About this task**

The following image indicates the location of the left-side cover and provides a visual representation of the installation procedure.





2x  
6-32



**Figure 11. Installing the left-side cover**

#### Steps

1. Holding the left-side cover firmly on both sides, slide it into the chassis towards the front of the computer.
2. Replace the two screws (6-32) that secure the left-side cover to the chassis.

#### Next steps

1. Follow the procedure in [After working inside your computer](#).

## Front cover

### Removing the front cover

#### Prerequisites

1. Follow the procedure in [Before working inside your computer](#).
2. Remove the [left-side cover](#).

#### About this task

The following image indicates the location of the front cover and provides a visual representation of the removal procedure.

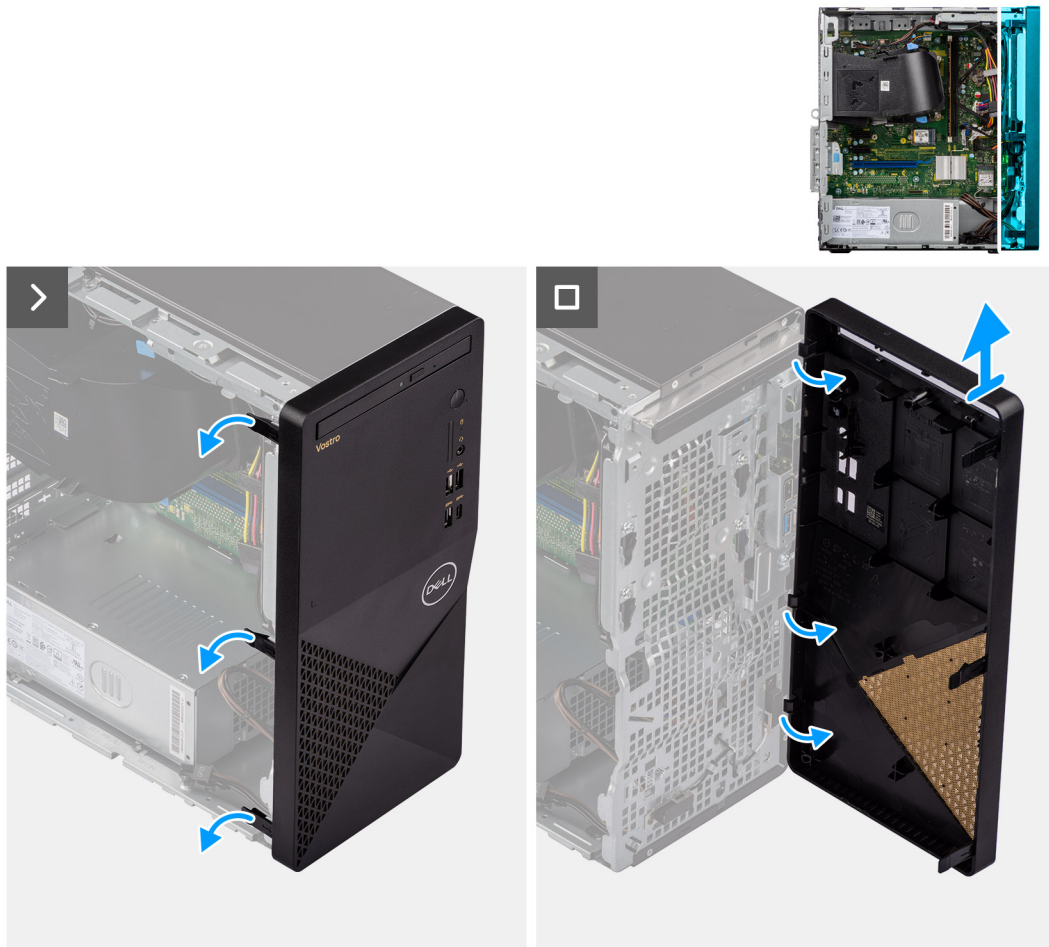

Figure 12. Removing the front cover

### Steps

1. Gently pry and release the tabs that secure the front-cover to the chassis.
2. Open the front cover and lift it away from the chassis.

## Installing the front cover

### Prerequisites

If you are replacing a component, remove the existing component before performing the installation process.

### About this task

The following image indicates the location of the front cover and provides a visual representation of the installation procedure.

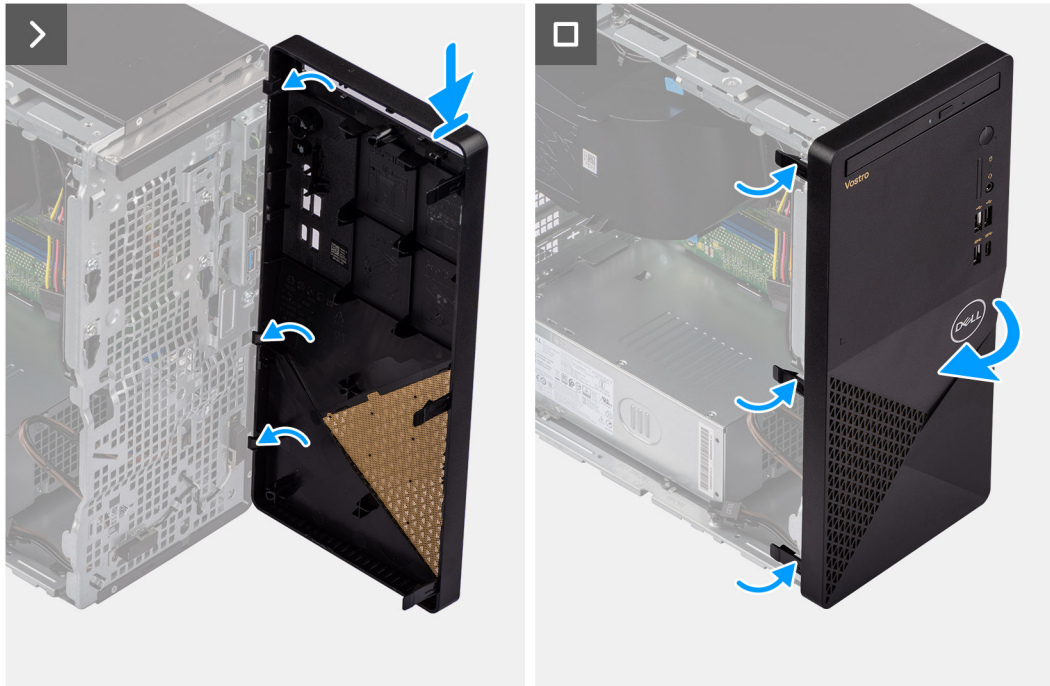

Figure 13. Installing the front cover

#### Steps

1. Align and insert the front-cover tabs into the slots on the right side of the chassis.
2. Rotate the front cover towards the chassis and snap the tabs into place.

#### Next steps

1. Install the [left-side cover](#).
2. Follow the procedure in [After working inside your computer](#).

## Memory

### Removing the memory

#### Prerequisites

1. Follow the procedure in [Before working inside your computer](#).
2. Remove the [left-side cover](#).

#### About this task

**NOTE:** This computer may have up to two memory modules installed.

The following image indicates the location of the memory and provides a visual representation of the removal procedure.

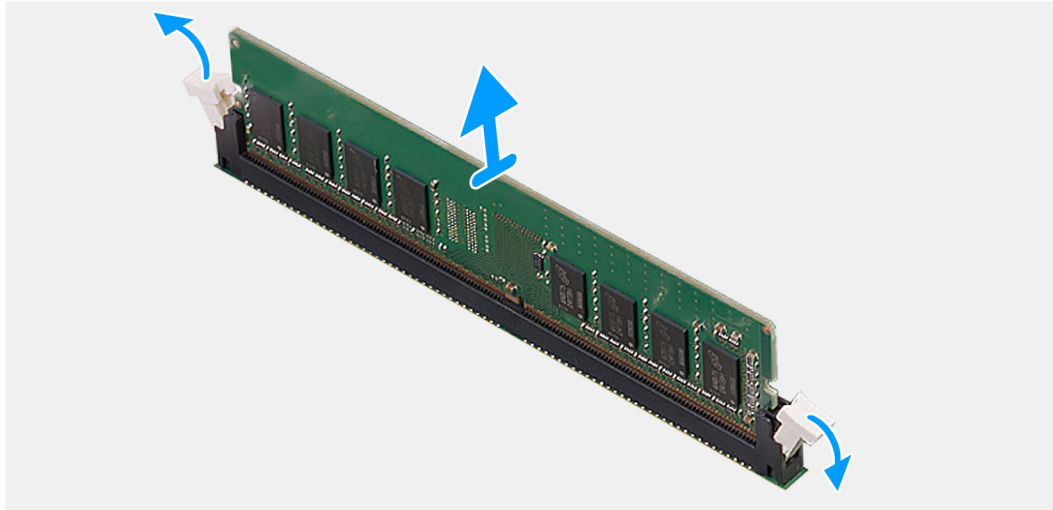
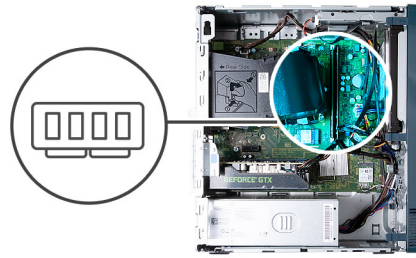

Figure 14. Removing the memory

### Steps

1. Place the computer on its side with the left side facing up.
2. Carefully spread apart the securing-clips on each end of the memory-module slot.
3. Grasp the memory module near the securing clip, and then gently ease the memory module out of the memory-module slot.

**CAUTION:** To prevent damage to the memory module, hold the memory module by the edges. Do not touch the components on the memory module.

**NOTE:** Repeat step 2 to step 3 to remove any other memory modules installed in your computer.

**NOTE:** Note the slot and the orientation of the memory module in order to replace it in the correct slot.

**NOTE:** If the memory module is difficult to remove, gently ease the memory module back and forth to remove it from the slot.

## Installing the memory

### Prerequisites

If you are replacing a component, remove the existing component before performing the installation process.

### About this task

**NOTE:** Up to two memory modules may be installed into this computer.

The following image indicate the location of the memory and provides a visual representation of the installation procedure.

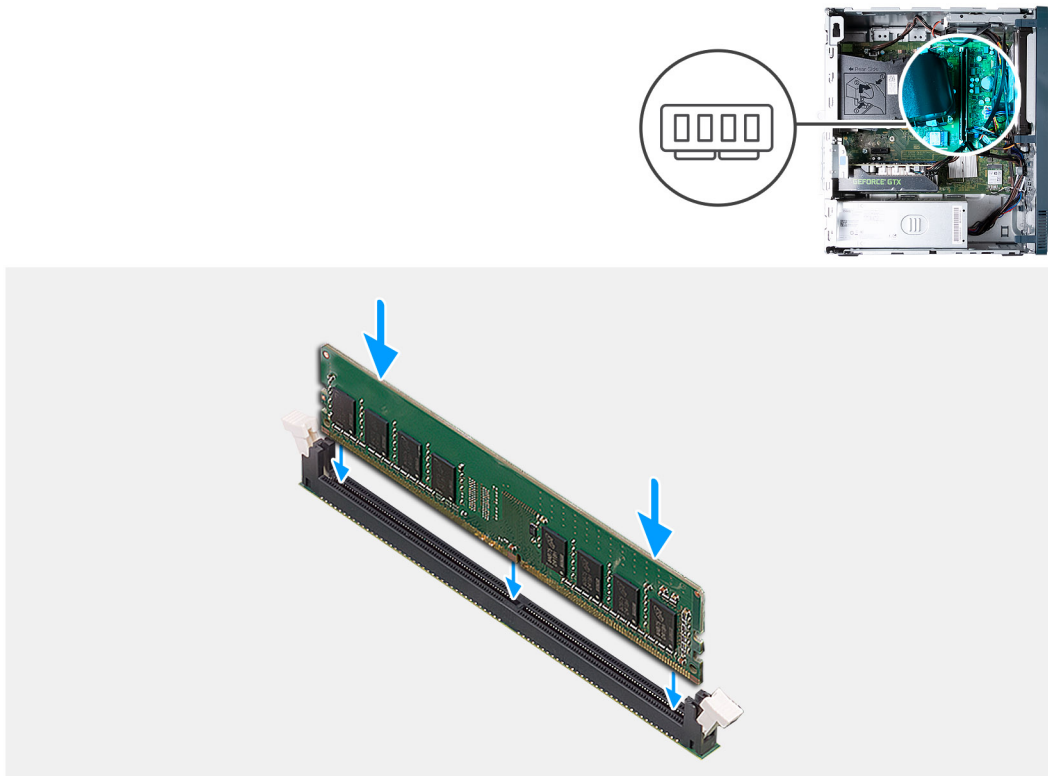

**Figure 15. Installing the memory**

**Steps**

1. Align the notch on the memory module with the tab on the memory-module slot.
2. Insert the memory module into the memory-module slot.
3. Press down on the memory module until the memory module snaps into position and the securing clip locks in place.

**CAUTION:** To prevent damage to the memory module, hold the memory module by the edges. Do not touch the components on the memory module.

**NOTE:** The securing clips return to the locked position. If you do not hear the click, remove the memory module and reinstall it.

**NOTE:** If the memory module is difficult to remove, gently ease the memory module back and forth to remove it from the slot.

4. Place the computer in an upright position.

**Next steps**

1. Install the [left-side cover](#).
2. Follow the procedure in [After working inside your computer](#).

## Solid-state drive

### Removing the solid-state drive

**Prerequisites**

1. Follow the procedure in [Before working inside your computer](#).
2. Remove the [left-side cover](#).

### About this task

**NOTE:** Depending on the configuration ordered, your computer may have a M.2 2230 or 2280 solid-state drive that is installed in the M.2 solid-state drive slot on the system board.

The following image indicates the location of the solid-state drive and provides a visual representation of the removal procedure.

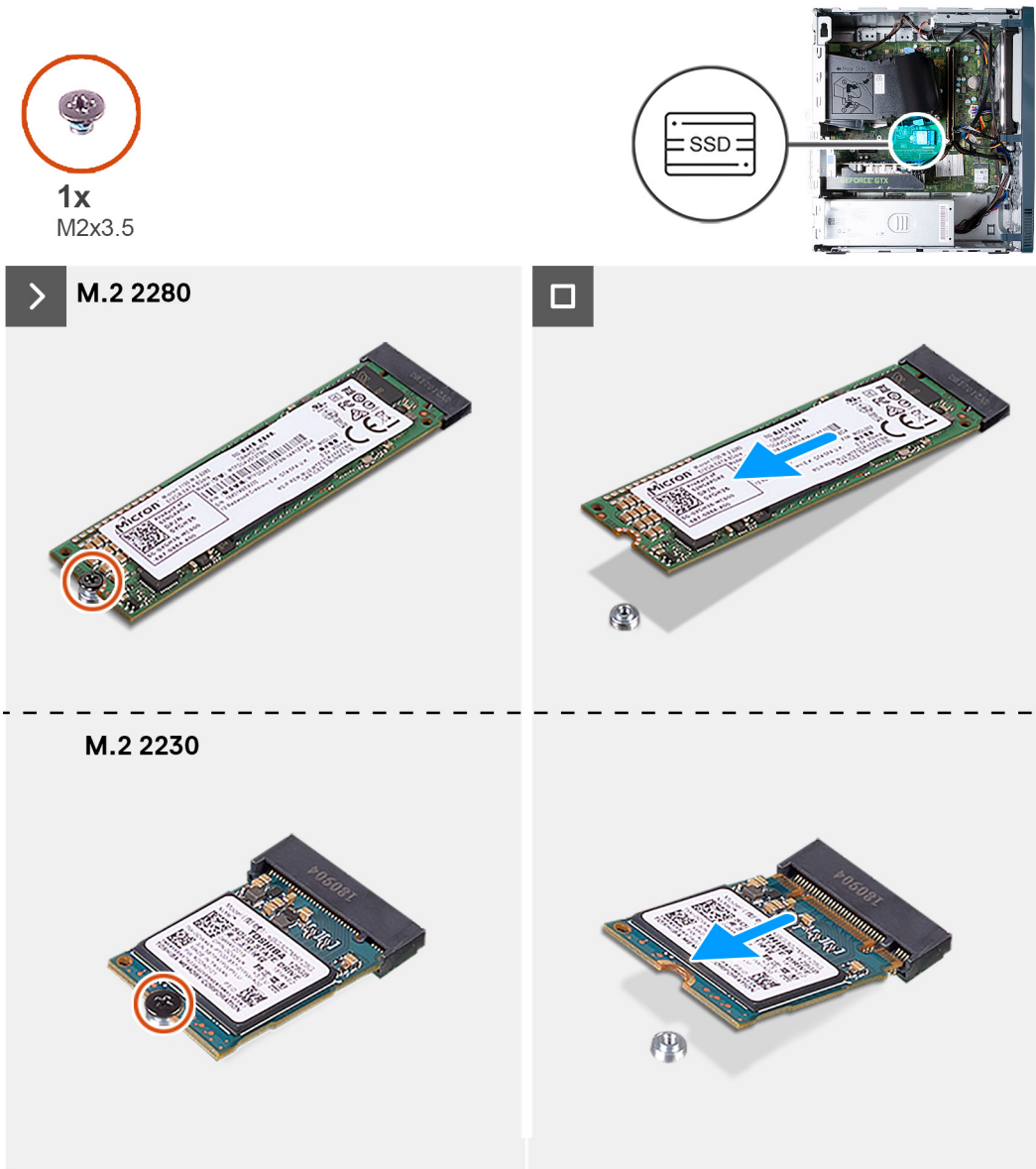

Figure 16. Removing the solid-state drive

### Steps

1. Place the computer on its side with the left side facing up.
2. Remove the screw (M2x3.5) that secures the solid-state drive to the system board.
3. Slide and lift the solid-state drive from the M.2 card slot on the system board.

## Installing the solid-state drive

### Prerequisites

If you are replacing a component, remove the existing component before performing the installation process.

### About this task

**NOTE:** You may install either a M.2 2230 or 2280 solid-state drive into the M.2 solid-state drive slot on the system board.

The following image indicates the location of the solid-state drive and provides a visual representation of the installation procedure.

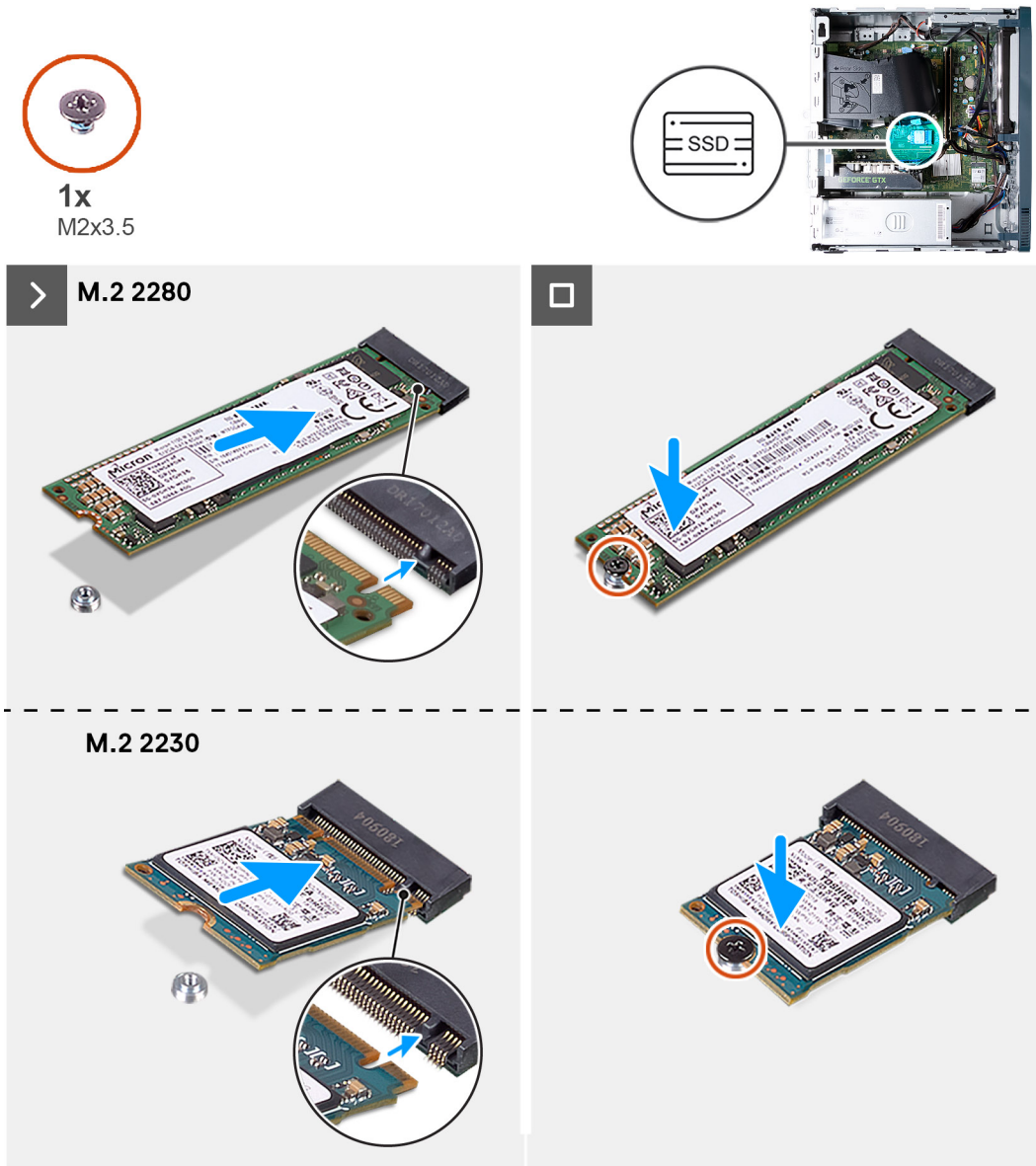

**Figure 17. Installing the solid-state drive**

### Steps

1. Align the notch on the solid-state drive with the tab on the M.2 card slot.
2. Slide the solid-state drive into the M.2 card slot on the system board.
3. Replace the screw (M2x3.5) that secures the solid-state drive to the system board.
4. Place the computer in an upright position.

### Next steps

1. Install the [left-side cover](#).
2. Follow the procedure in [After working inside your computer](#).

# Coin-cell battery

## Removing the coin-cell battery

### Prerequisites

1. Follow the procedure in [Before working inside your computer](#).
2. Remove the [left-side cover](#).

### About this task

The following image indicates the location of the coin-cell battery and provides a visual representation of the removal procedure.

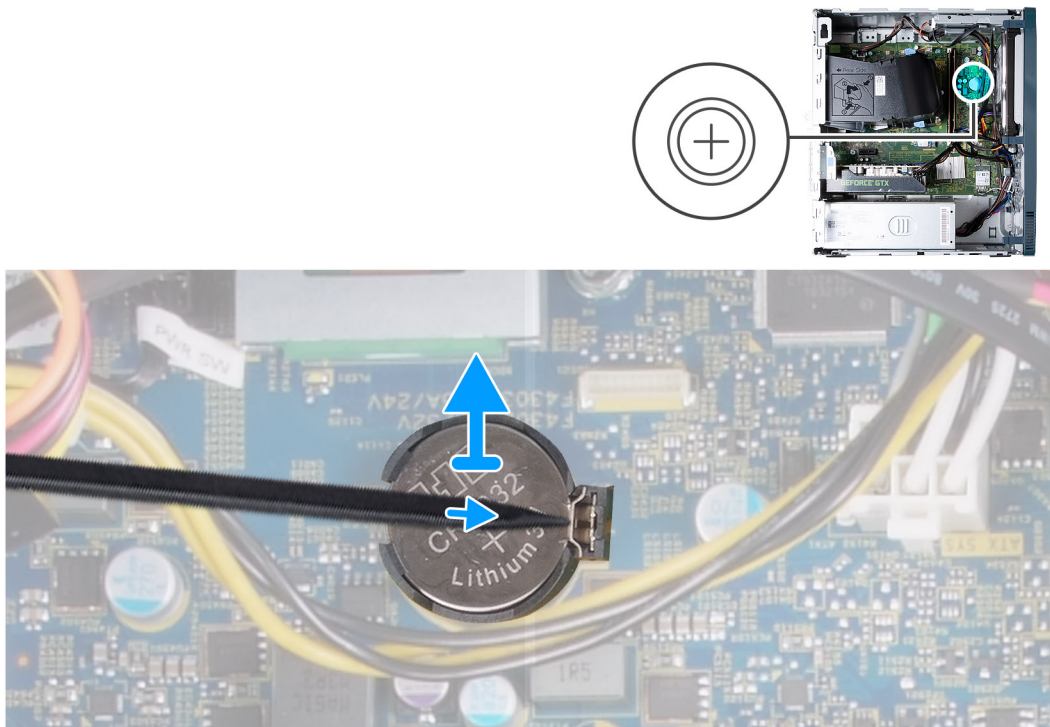

**Figure 18. Removing the coin-cell battery**

### Steps

1. Place the computer on its side with the left side facing up.
2. Using a plastic scribe, push the coin-cell battery securing-clip on the coin-cell battery socket to release the coin-cell battery.
3. Remove the coin-cell battery from the system board.

## Installing the coin-cell battery

### Prerequisites

If you are replacing a component, remove the existing component before performing the installation process.

### About this task

The following image indicates the location of the coin-cell battery and provides a visual representation of the installation procedure.



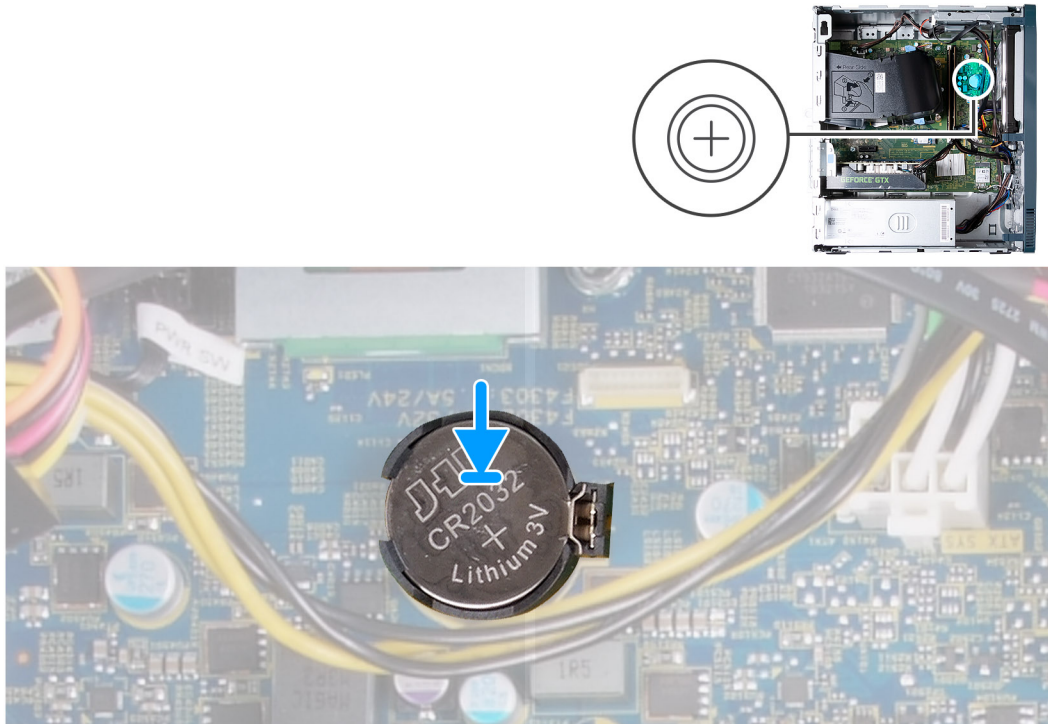

**Figure 19. Installing the coin-cell battery**

**Steps**

1. Insert the coin-cell battery into the socket with the positive side (+) label facing up and snap the battery in the socket.
2. Place the computer in an upright position.

**Next steps**

1. Install the [left-side cover](#).
2. Follow the procedure in [After working inside your computer](#).

## Wireless card

### Removing the wireless card

**Prerequisites**

1. Follow the procedure in [Before working inside your computer](#).
2. Remove the [left-side cover](#).

**About this task**

The following image indicates the location of the wireless card and provides a visual representation of the removal procedure.



**Figure 20. Removing the wireless card**

**Steps**

1. Place the computer on its side with the left side facing up.
2. Remove the screw (M2x4) that secures the wireless card to the system board.
3. Slide and lift the wireless-card bracket off the wireless card.
4. Disconnect the antenna cables from the wireless card.
5. Slide and remove the wireless card at an angle from the wireless-card slot.

## Installing the wireless card

**Prerequisites**

If you are replacing a component, remove the existing component before performing the installation process.

**About this task**

The following image indicates the location of the wireless card and provides a visual representation of the installation procedure.



Figure 21. Installing the wireless card

**Steps**

1. Connect the antenna cables to the wireless card.

Table 22. Antenna-cable color scheme

Connectors on the wireless card	Antenna-cable color	Silkscreen marking	
Main	White	MAIN	△ (white triangle)
Auxiliary	Black	AUX	▲ (black triangle)

2. Slide and place the wireless-card bracket on the wireless card.
3. Align the notch on the wireless card with the tab on the wireless-card slot.
4. Slide the wireless card at an angle into the wireless-card slot.
5. Replace the screw (M2x4) that secures the wireless card to the system board.
6. Place the computer in an upright position.

**Next steps**

1. Install the [left-side cover](#).

2. Follow the procedure in [After working inside your computer](#).

# Graphics card

## Removing the graphics card

### Prerequisites

1. Follow the procedure in [Before working inside your computer](#).
2. Remove the [left-side cover](#).

### About this task

 **NOTE:** Depending on the configuration ordered, your computer may not have a discrete graphics card installed.

The following image indicates the location of the graphics card and provides a visual representation of the removal procedure.

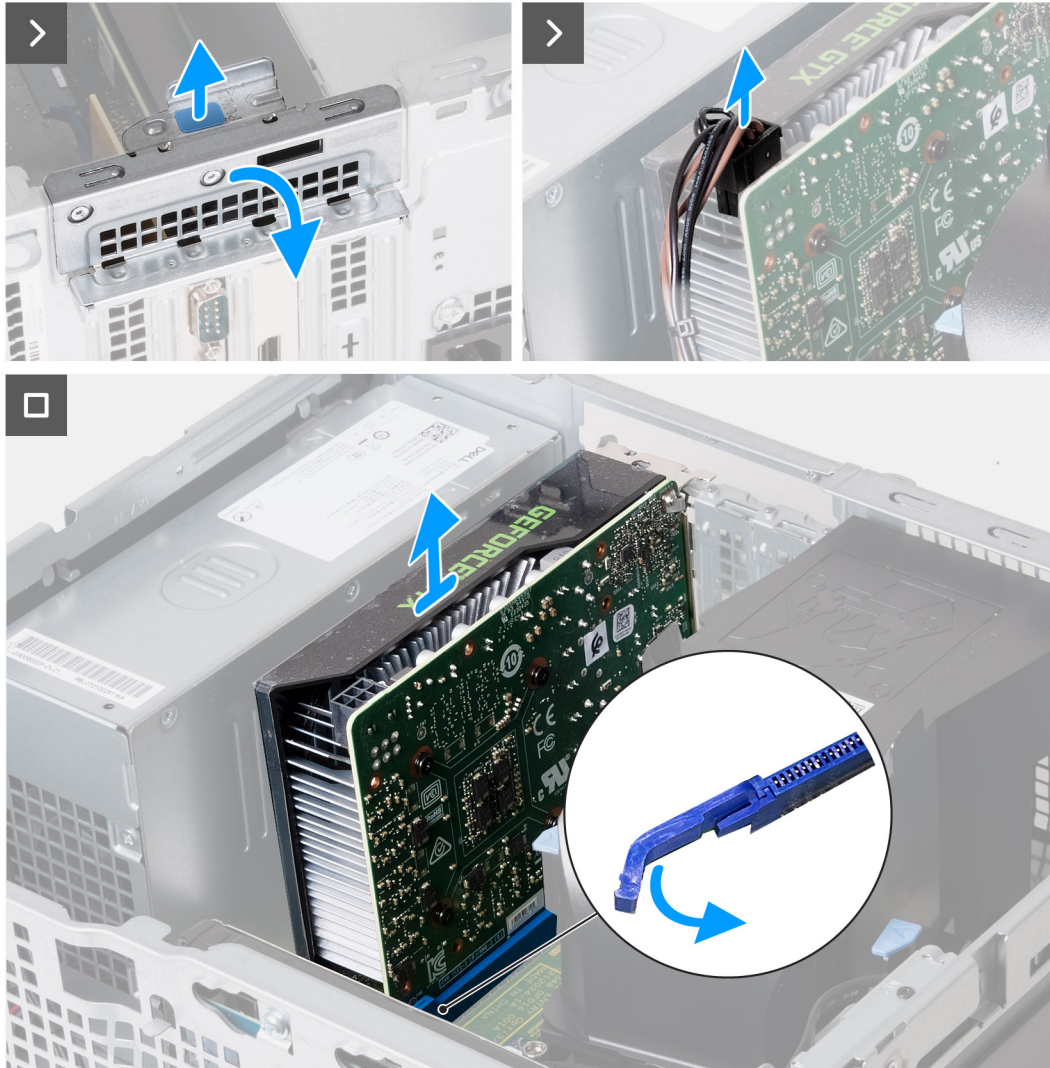

**Figure 22. Removing the graphics card**

### Steps

1. Place the computer on its side with the left side facing up.
2. Lift the tab to open the card-retention bracket.
3. Disconnect the graphics-card power cable from the graphics card.
4. Push the securing tab on the PCIe x16 slot away from the graphics card.
5. Lift the graphics card off the system board.

## Installing the graphics card

### Prerequisites

If you are replacing a component, remove the existing component before performing the installation process.

### About this task

The following image indicates the location of the graphics card and provides a visual representation of the installation procedure.

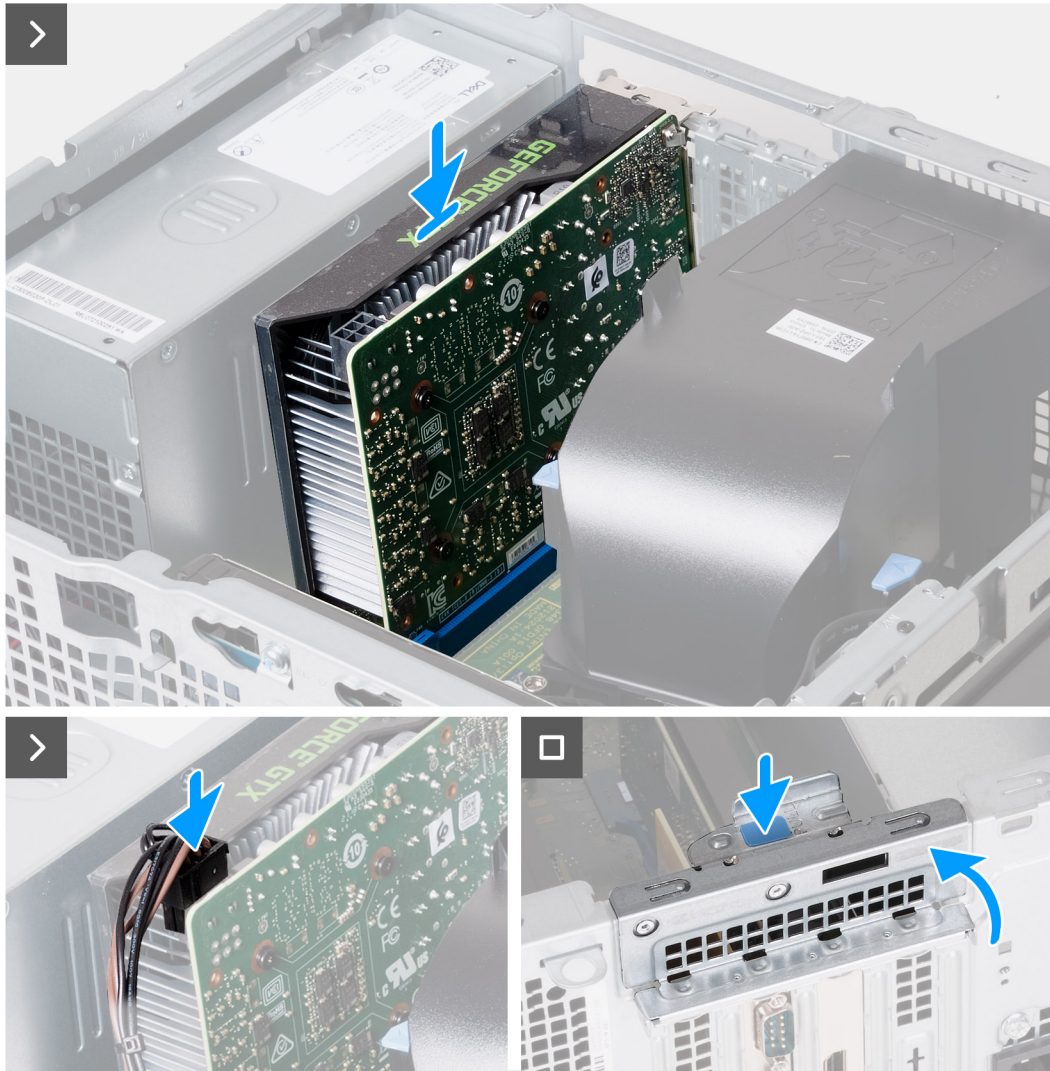

**Figure 23. Installing the graphics card**

### Steps

1. Align the graphics card with the PCIe x16 slot on the system board.
2. Place the card into the slot and press down firmly until the graphics card snaps into place.
3. Connect the graphics-card power cable to the graphics card.
4. Rotate the card retention bracket towards the chassis until it snaps into place.
5. Place the computer in an upright position.

### Next steps

1. Install the [left-side cover](#).

2. Follow the procedure in [After working inside your computer](#).

## Hard drive

### Removing the hard drive

#### Prerequisites

1. Follow the procedure in [Before working inside your computer](#).
2. Remove the [left-side cover](#).
3. Remove the [front cover](#).

#### About this task

The following image indicates the location of the hard drive and provides a visual representation of the removal procedure.

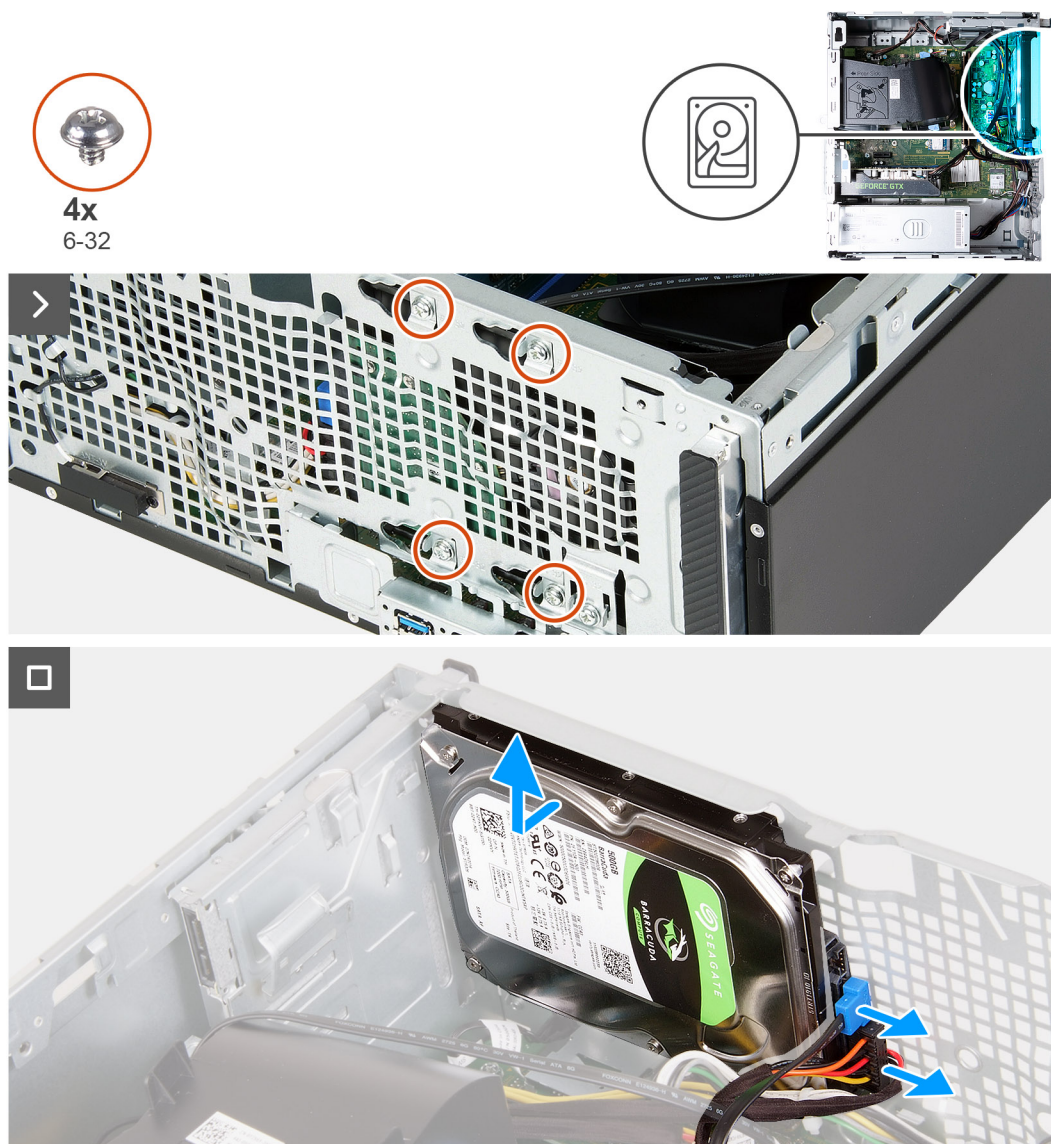

**Figure 24. Removing the hard drive**

#### Steps

1. Place the computer on its side with the left side facing up.

2. Holding the hard drive in place, remove the four screws (6-32) that secure the hard drive to the chassis.
3. Disconnect the data and power cables from the hard drive.
4. Lift the hard drive off the chassis.

## Installing the hard drive

### Prerequisites

If you are replacing a component, remove the existing component before performing the installation process.

### About this task

The following image indicates the location of the hard drive and provides a visual representation of the installation procedure.



Figure 25. Installing the hard drive

### Steps

1. Connect the data cable and power cable to the hard drive.
2. Place the hard drive onto the chassis and align the screw holes of the hard drive with the screw holes of the chassis.
3. Replace the four screws (6-32) that secure the hard drive to the chassis.
4. Place the computer in an upright position.



### Next steps

1. Install the [front cover](#).
2. Install the [left-side cover](#).
3. Follow the procedure in [After working inside your computer](#).

## Power button

### Removing the power button

#### Prerequisites

1. Follow the procedure in [Before working inside your computer](#).
2. Remove the [left-side cover](#).
3. Remove the [front cover](#).
4. Remove the [hard drive](#).

#### About this task

The following image indicates the location of the power button and provides a visual representation of the removal procedure.

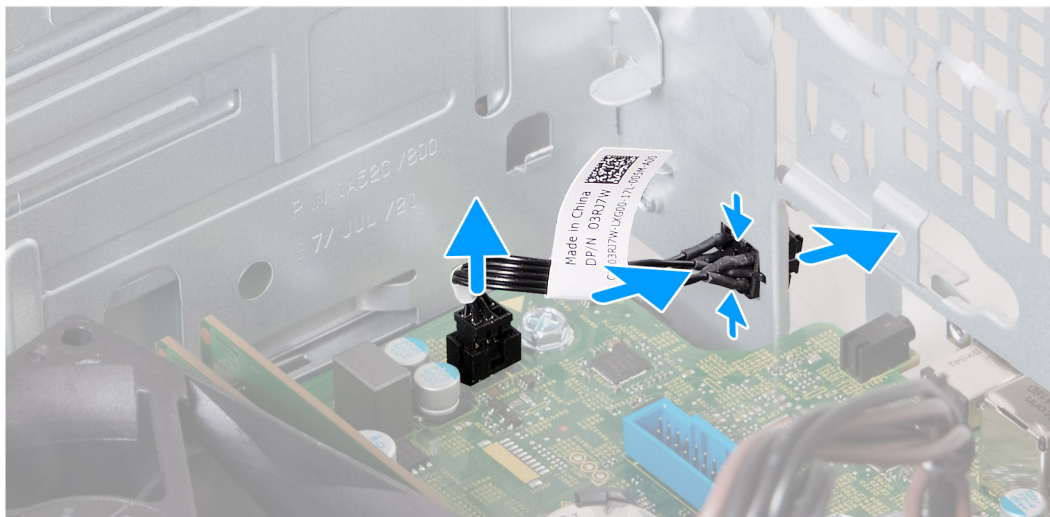

**Figure 26. Removing the power button**

#### Steps

1. Disconnect the power-button cable from the system board.
2. Press the release tab on the power button to release it from the slot on the chassis.
3. Route the power button along with its cable through the slot on the chassis.
4. Remove the power button and its cable from the front of the chassis.

# Installing the power button

## Prerequisites

If you are replacing a component, remove the existing component before performing the installation process.

## About this task

The following image indicates the location of the power button and provides a visual representation of the installation procedure.



Figure 27. Installing the power button

## Steps

1. Slide the power-button cable through the slot on the front of the chassis.
2. Align the tabs on the side of the power button with the cutouts on the slot in the chassis.
3. While pressing the tabs on the power button, insert it through the slot on the chassis and then secure it into place.
4. Connect the power-button cable to the system board.

## Next steps

1. Install the [hard drive](#).
2. Install the [front cover](#).
3. Install the [left-side cover](#).
4. Follow the procedure in [After working inside your computer](#).

# Optical drive

## Removing the optical drive

### Prerequisites

1. Follow the procedure in [Before working inside your computer](#).
2. Remove the [left-side cover](#).
3. Remove the [front cover](#).

### About this task

**i** **NOTE:** Depending on the configuration ordered, your computer may not have an optical drive installed.

The following image indicates the location of the optical drive and provides a visual representation of the removal procedure.

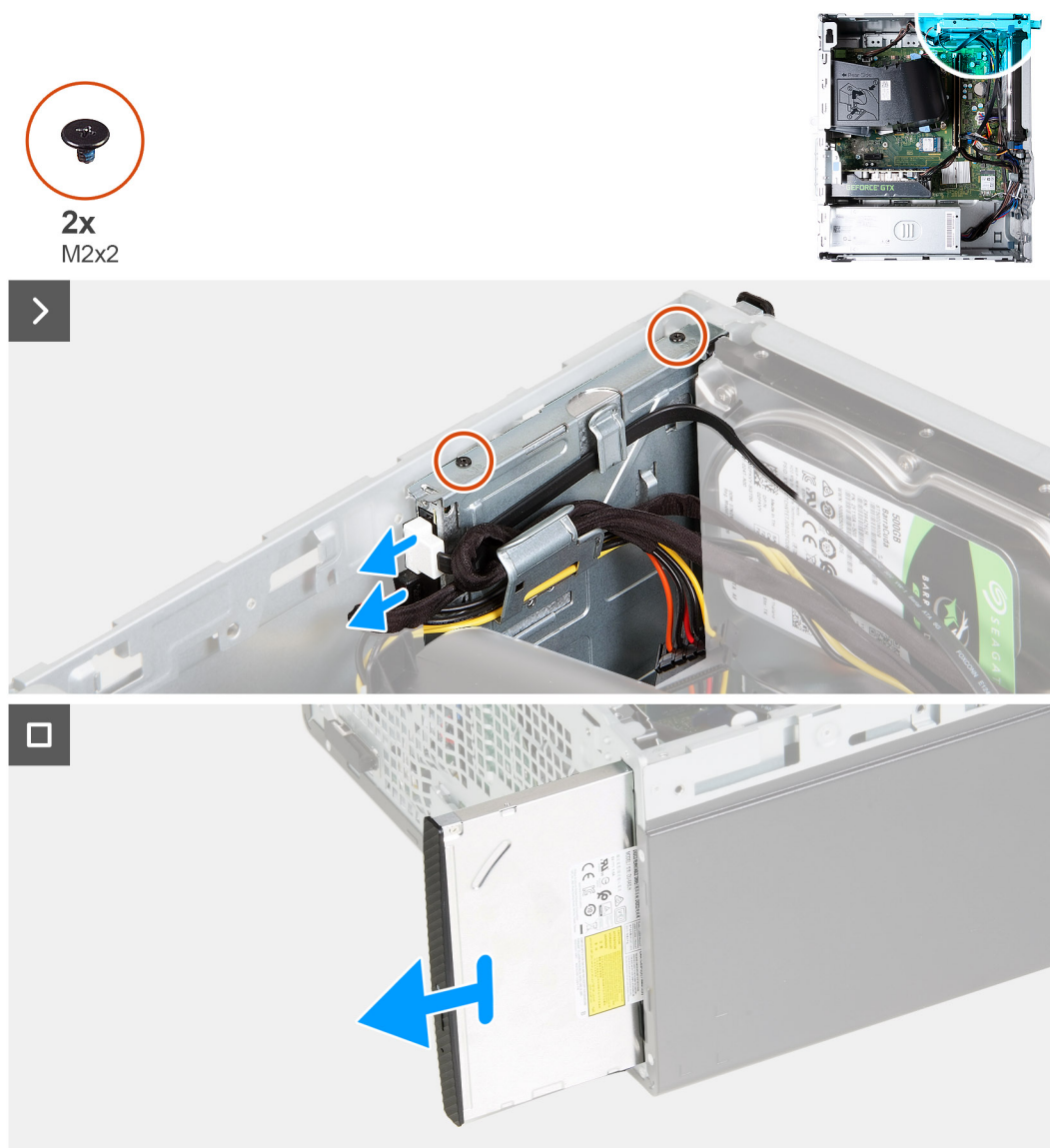

**Figure 28. Removing the optical drive**

### Steps

1. Place the computer on its side with the left-side facing up.

2. Disconnect the power and data cables from the optical drive.
3. Remove the two screws (M2x2) that secure the optical drive to the optical-drive cage.
4. Pull to slide out the optical drive through the front of the computer.

## Installing the optical drive

### Prerequisites

If you are replacing a component, remove the existing component before performing the installation process.

### About this task

The following image indicates the location of the optical drive and provides a visual representation of the installation procedure.

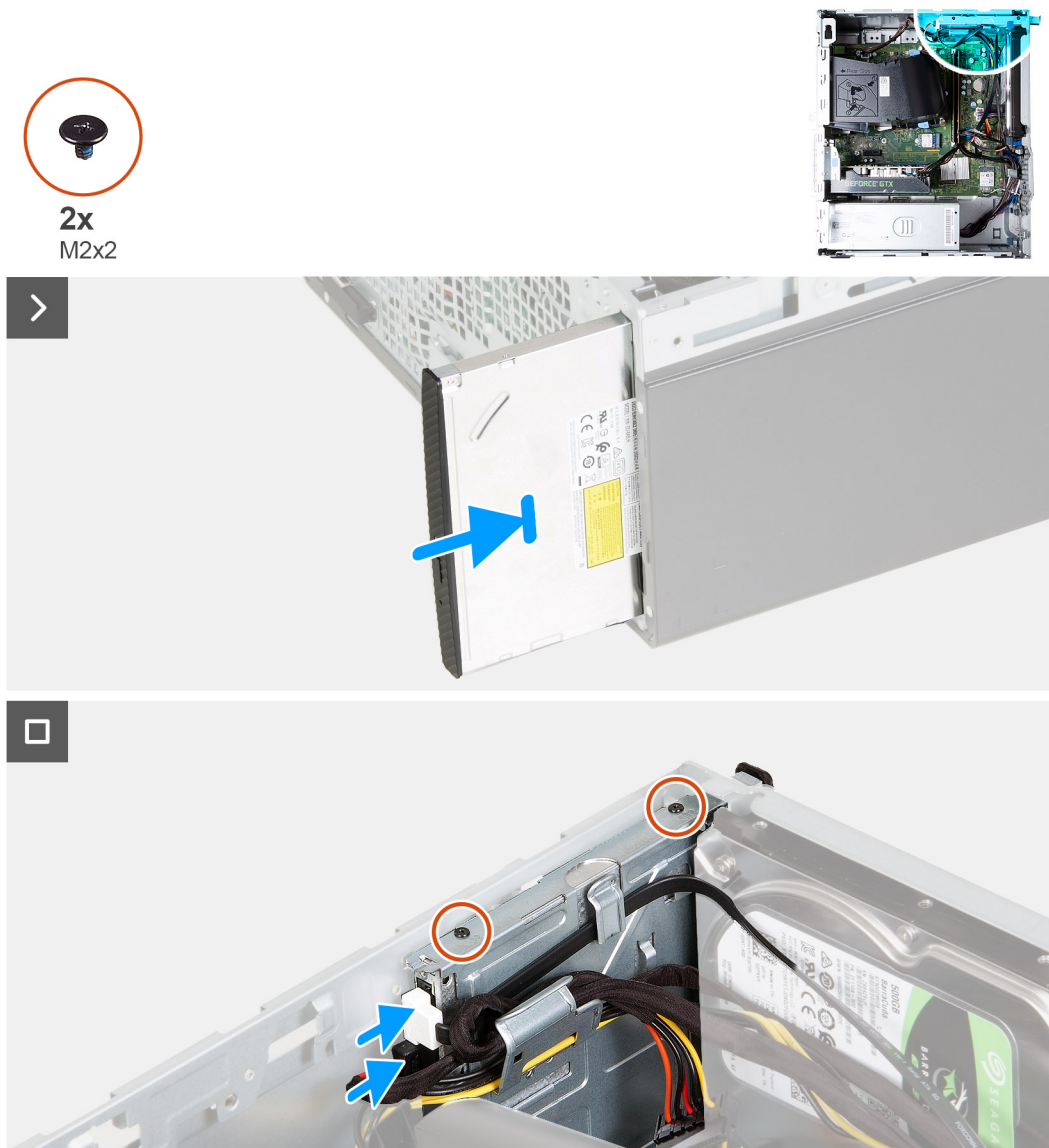

**Figure 29. Installing the optical drive**

### Steps

1. Slide the optical drive into the optical-drive cage through the front of the computer.
2. Replace the two screws (M2x2) that secure the optical drive to the optical-drive cage.
3. Connect the power and data cables to the optical drive.
4. Place the computer in an upright position.

### Next steps

1. Install the [front cover](#).
2. Install the [left-side cover](#).
3. Follow the procedure in [After working inside your computer](#).

## Optical-drive bezel

### Removing the optical-drive bezel

#### Prerequisites

1. Follow the procedure in [Before working inside your computer](#).
2. Remove the [left-side cover](#).
3. Remove the [front cover](#).
4. Remove the [optical drive](#).

#### About this task

 **NOTE:** Depending on the configuration ordered, your computer may not have an optical drive installed.

The following image indicates the location of the optical-drive bezel and provides a visual representation of the removal procedure.

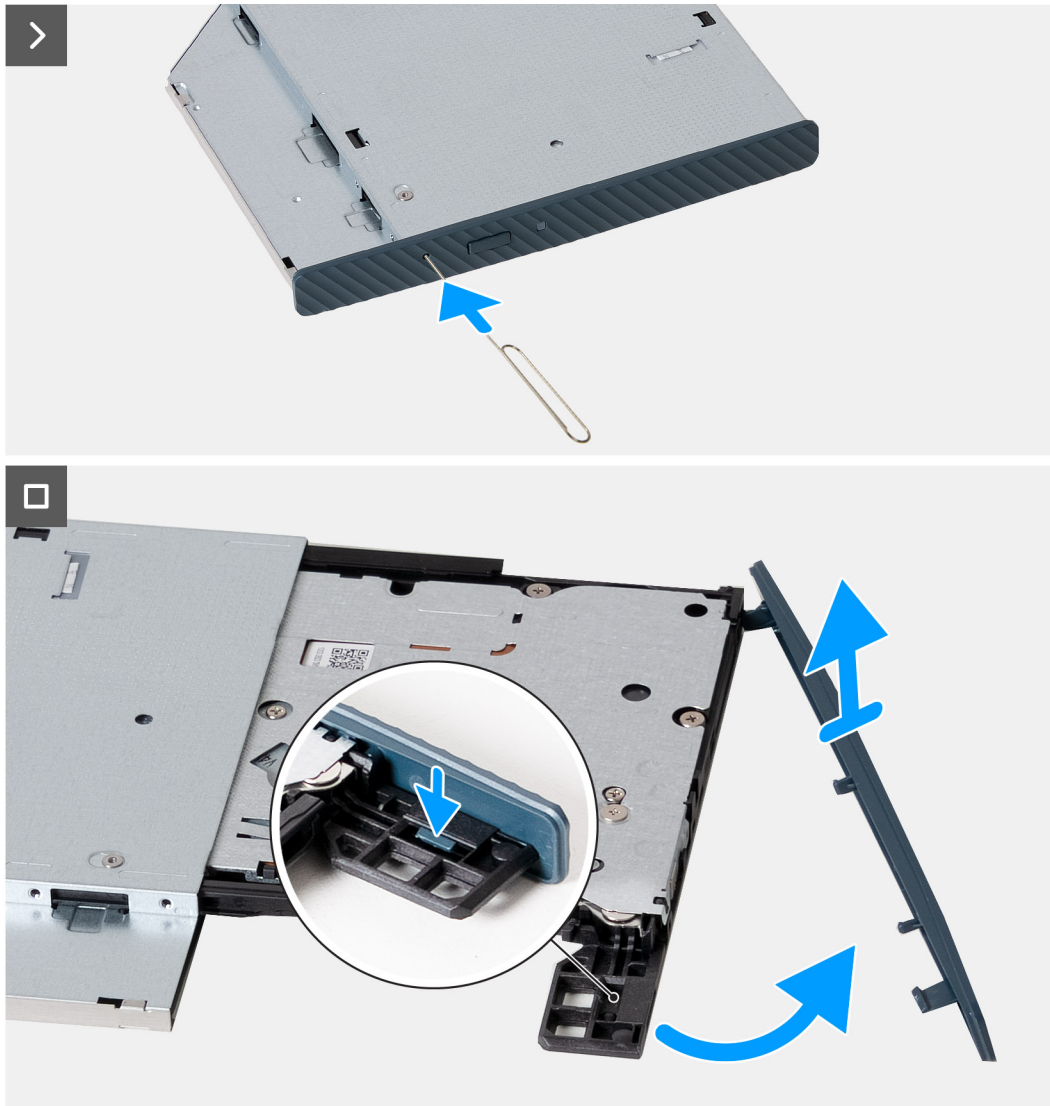

**Figure 30. Removing the optical-drive bezel**

### Steps

1. Insert an unfolded paperclip into the emergency eject pinhole of the optical drive to open the drive tray.
2. Using a plastic scribe press down the tab that secures the optical-drive bezel to the optical drive.
3. Lift the optical-drive bezel away from the optical drive.

## Installing the optical-drive bezel

### Prerequisites

If you are replacing a component, remove the existing component before performing the installation process.

### About this task

The following image indicates the location of the optical-drive bezel and provides a visual representation of the installation procedure.

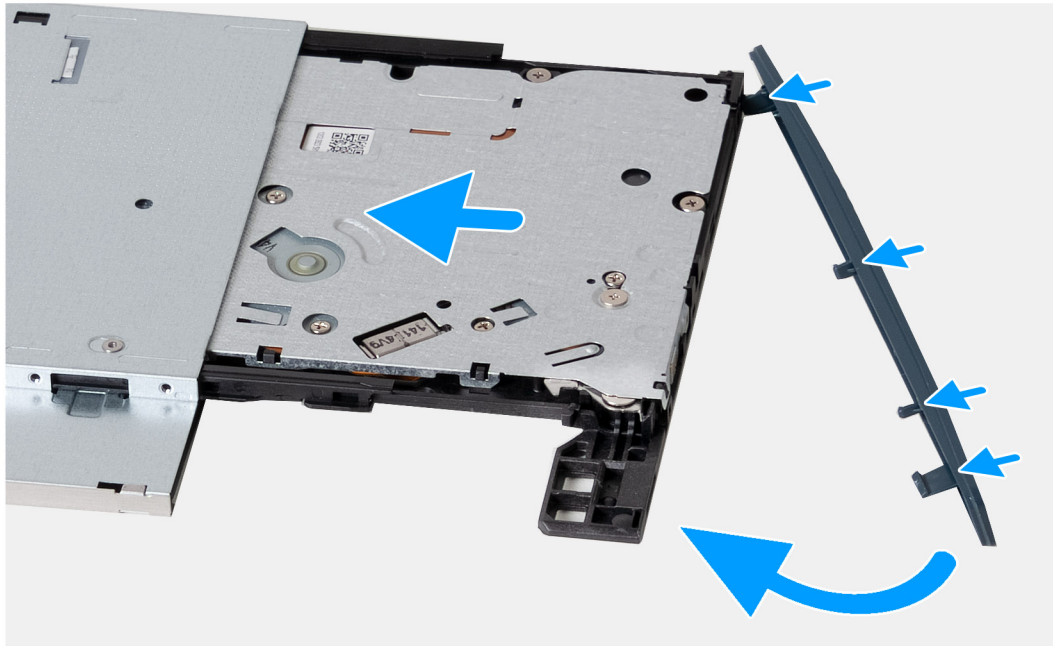

**Figure 31. Installing the optical-drive bezel**

**Steps**

1. Align the tabs on the optical-drive bezel with the slots on the optical drive and snap it in place.
2. Slide the optical-drive tray into the optical drive and close it.

**Next steps**

1. Install the [optical drive](#).
2. Install the [front cover](#).
3. Install the [left-side cover](#).
4. Follow the procedure in [After working inside your computer](#).

## Fan shroud

### Removing the fan shroud

**Prerequisites**

1. Follow the procedure in [Before working inside your computer](#).
2. Remove the [left-side cover](#).

**About this task**

The following image indicates the location of the fan shroud and provides a visual representation of the removal procedure.

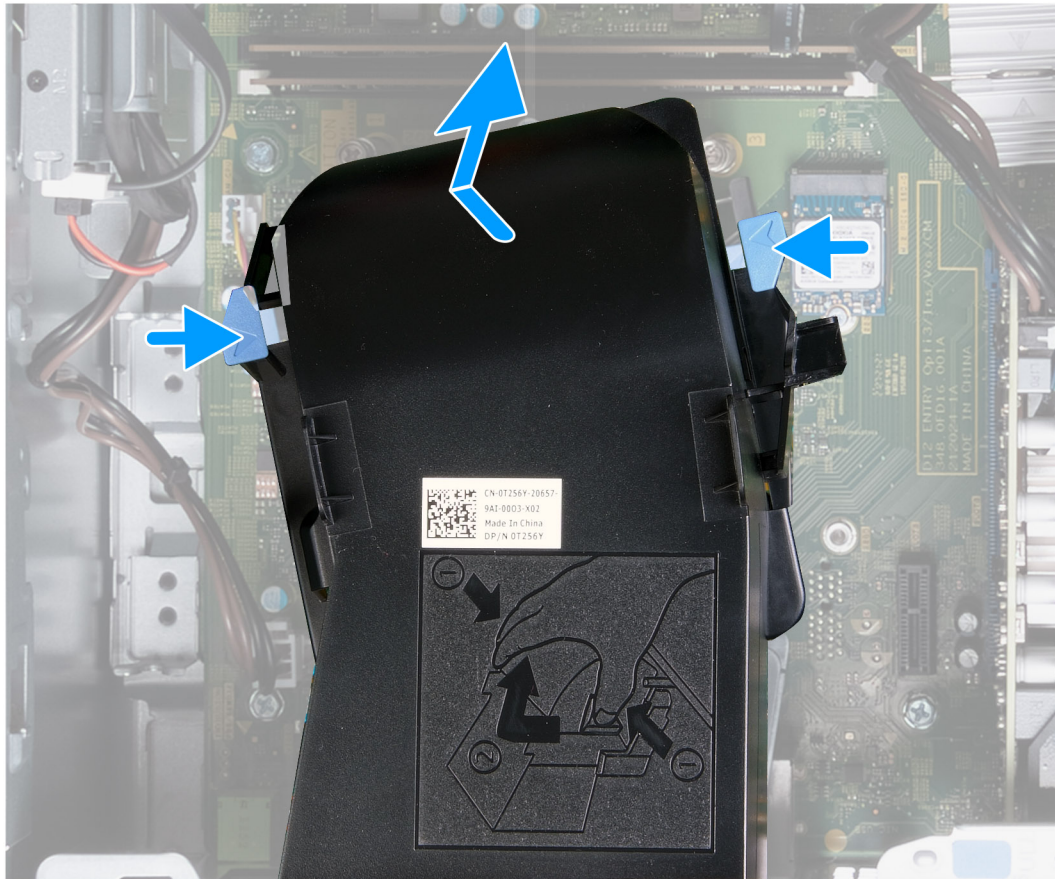

**Figure 32. Removing the fan shroud**

**Steps**

1. Place the computer on its side with the left side facing up.
2. Press the securing clips to release the fan shroud from the fan and heat-sink assembly.
3. Lift the fan shroud off the fan and heat-sink assembly.

## Installing the fan shroud

**Prerequisites**

If you are replacing a component, remove the existing component before performing the installation process.

**About this task**

The following image indicates the location of the fan shroud and provides a visual representation of the installation procedure.



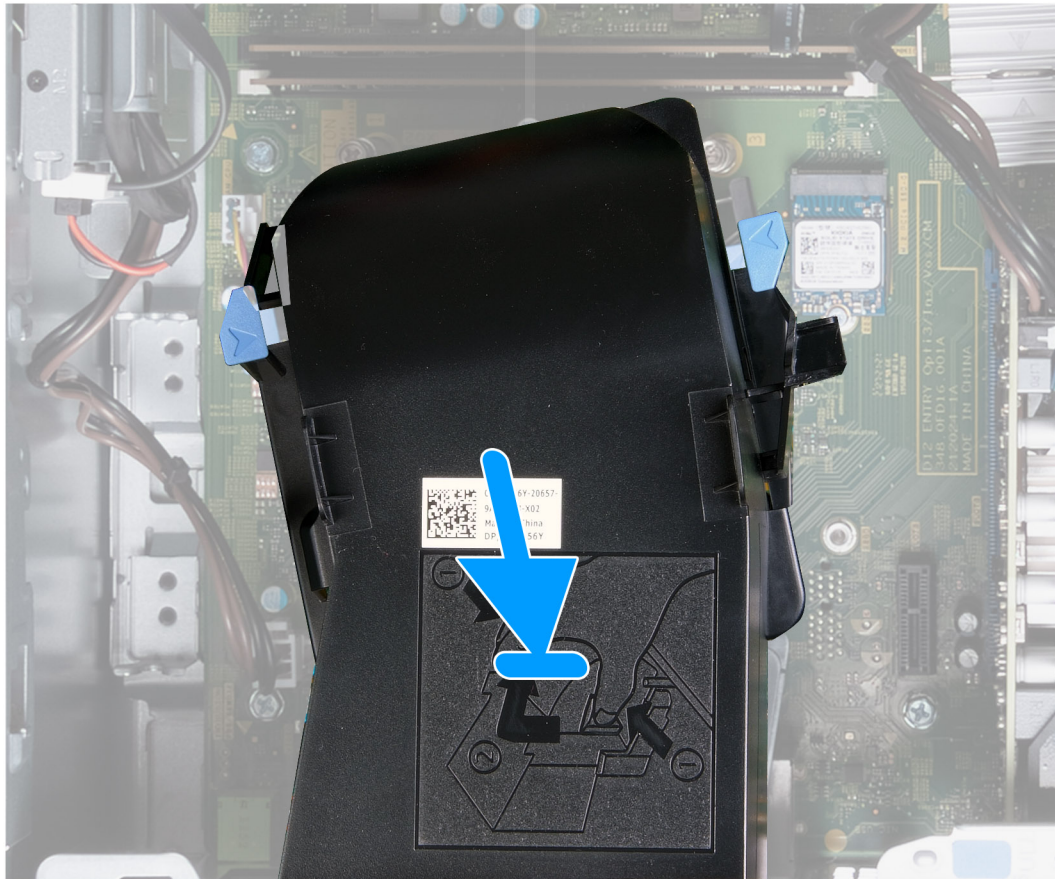

**Figure 33. Installing the fan shroud**

**Steps**

1. Place the fan shroud on the fan and heat-sink assembly.
2. Press the fan shroud against the fan and heat sink assembly to snap the fan shroud in place.
3. Place the computer in an upright position.

**Next steps**

1. Install the [left-side cover](#).
2. Follow the procedure in [After working inside your computer](#).

## Media-card reader

### Removing the media-card reader

**Prerequisites**

1. Follow the procedure in [Before working inside your computer](#).

2. Remove the [left-side cover](#).
3. Remove the [front cover](#).
4. Remove the [hard drive](#).

### About this task

The following image indicates the location of the media-card reader and provides a visual representation of the removal procedure.

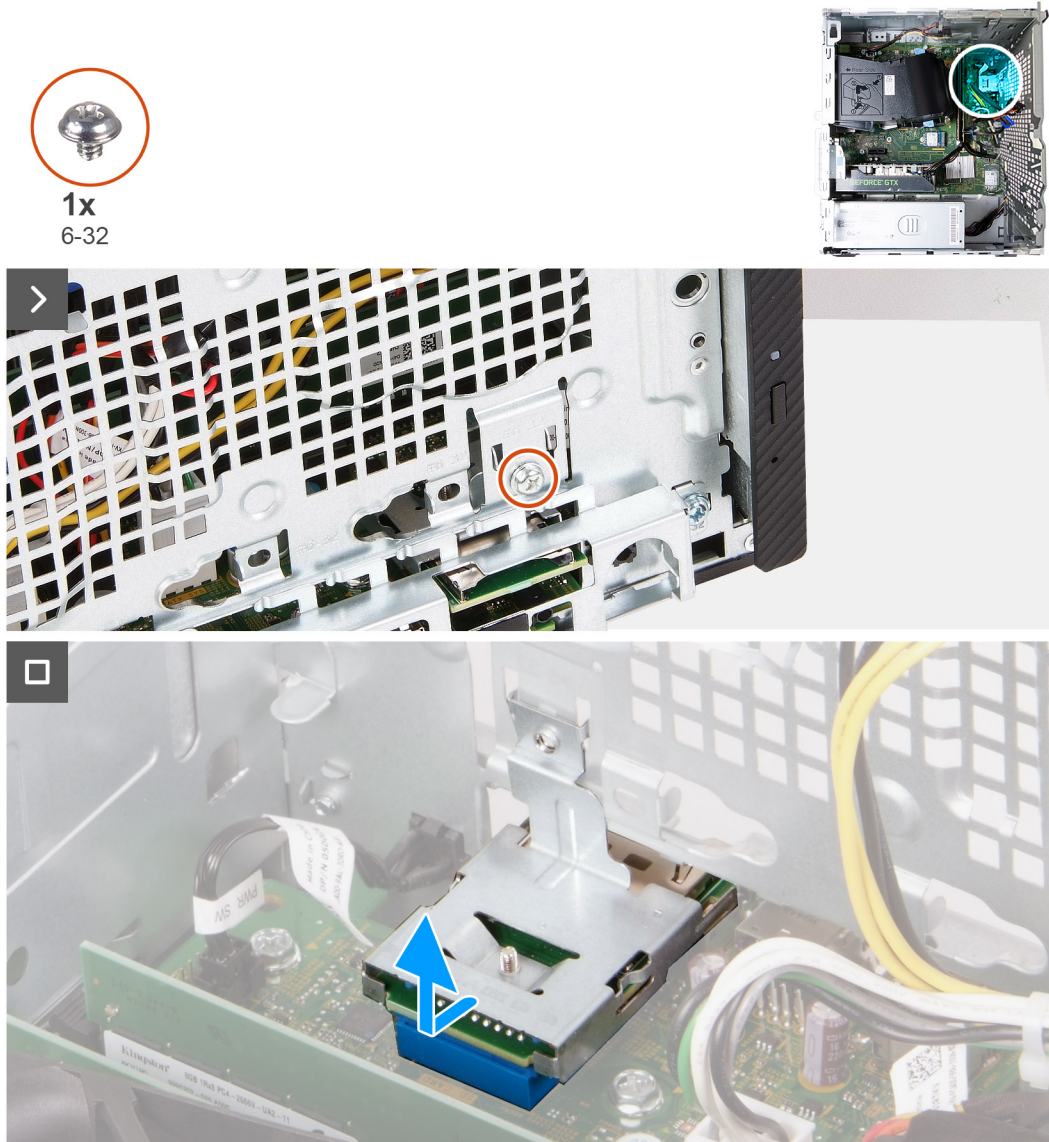

**Figure 34. Removing the media-card reader**

### Steps

1. Remove the screw (6-32) that secures the media-card reader bracket to the chassis.
2. Using the screw and the screwdriver push against the media-card reader to release it from the chassis.
3. Slide and lift the media-card reader and its bracket off the system board.

## Installing the media-card reader

### Prerequisites

If you are replacing a component, remove the existing component before performing the installation process.

### About this task

The following image indicates the location of the media-card reader and provides a visual representation of the installation procedure.

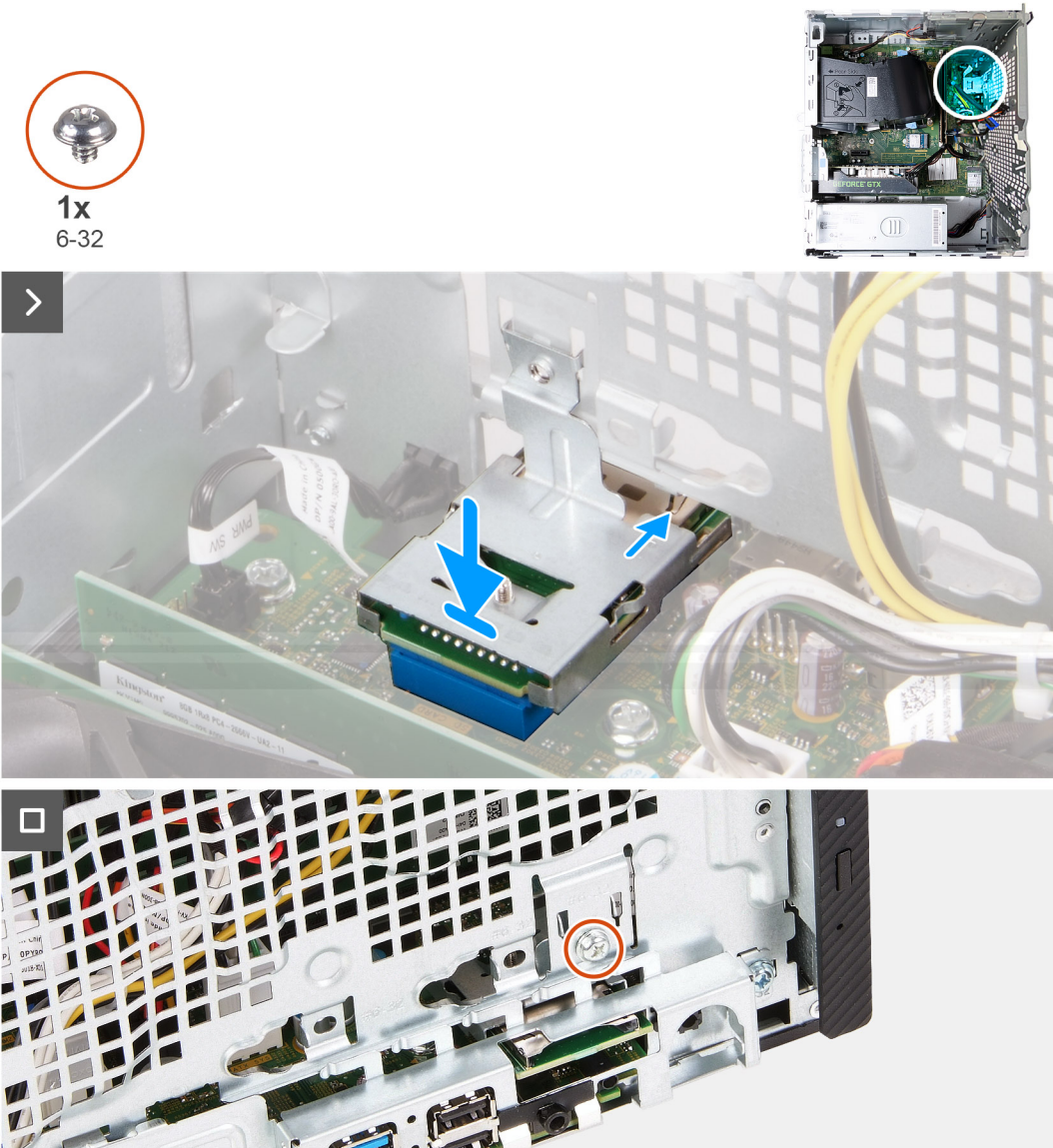

**Figure 35. Installing the media-card reader**

### Steps

1. Place and slide the media-card reader onto its slot on the system board.
2. Align the screw hole on the media-card reader bracket with the screw hole on the chassis.
3. Replace the screw (6-32) that secures the media-card reader bracket to the chassis.

### Next steps

1. Install the [hard drive](#).
2. Install the [front cover](#).
3. Install the [left-side cover](#).
4. Follow the procedure in [After working inside your computer](#).

# Power-supply unit

## Removing the power-supply unit

### Prerequisites

1. Follow the procedure in [Before working inside your computer](#).
2. Remove the [left-side cover](#).

### About this task

The following image indicates the location of the power-supply unit and provides a visual representation of the removal procedure.

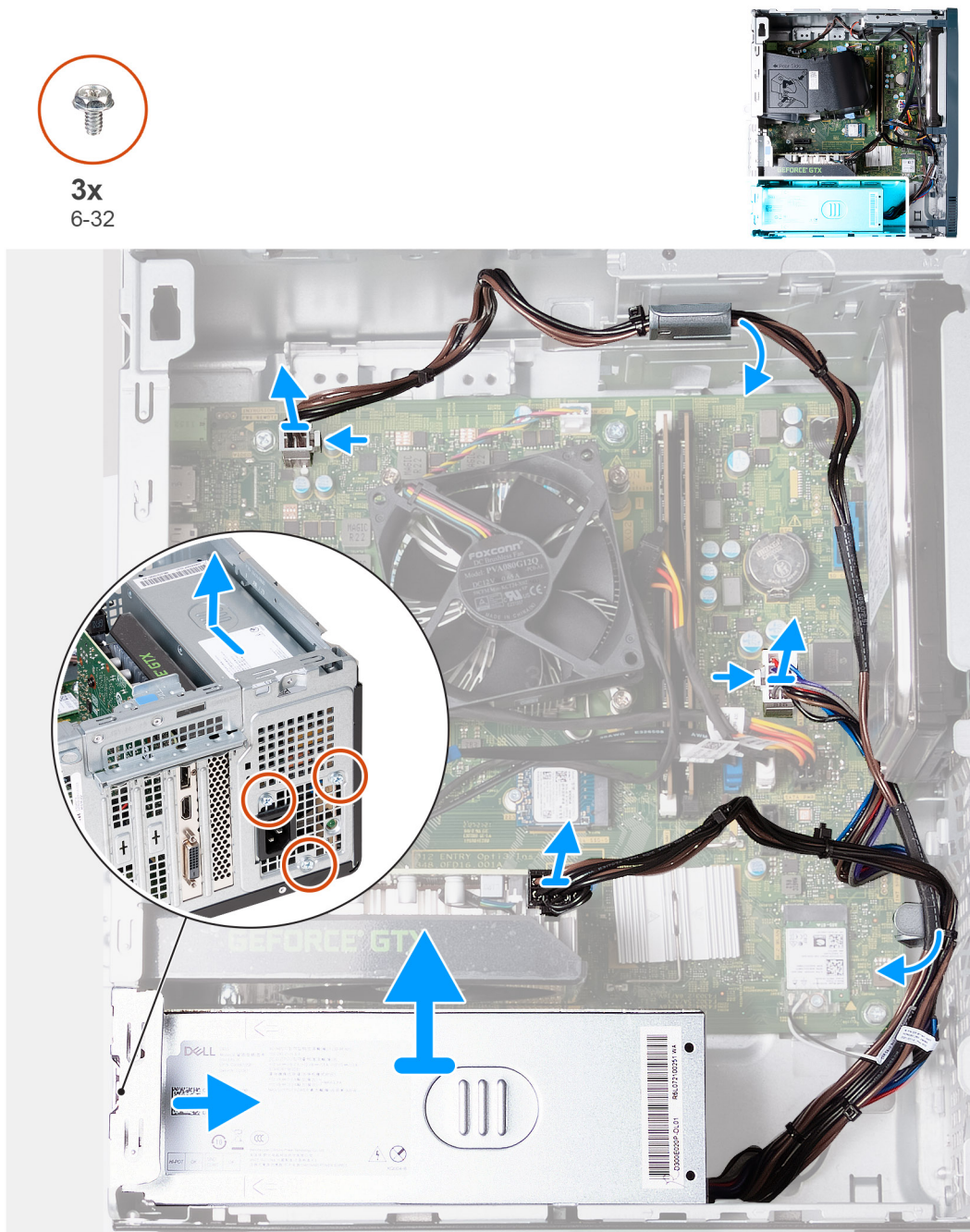

Figure 36. Removing the power-supply unit

**Steps**

1. Place the computer on its side with the left side facing up.
2. Disconnect the graphics-card power cable from the graphics card.
3. Press the securing clip and disconnect the processor-power cable from the system board.
4. Press the securing clip and disconnect the system-board power cable from the system board.
5. Remove the power-supply unit cables from the routing guides on the chassis.
6. Remove the three screws (#6-32) that secure the power-supply unit to the chassis.
7. Slide and lift the power-supply unit off the chassis.

## Installing the power-supply unit

**Prerequisites**

If you are replacing a component, remove the existing component before performing the installation process.

**About this task**

The following image indicates the location of the power-supply unit and provides a visual representation of the installation procedure.



3x  
6-32

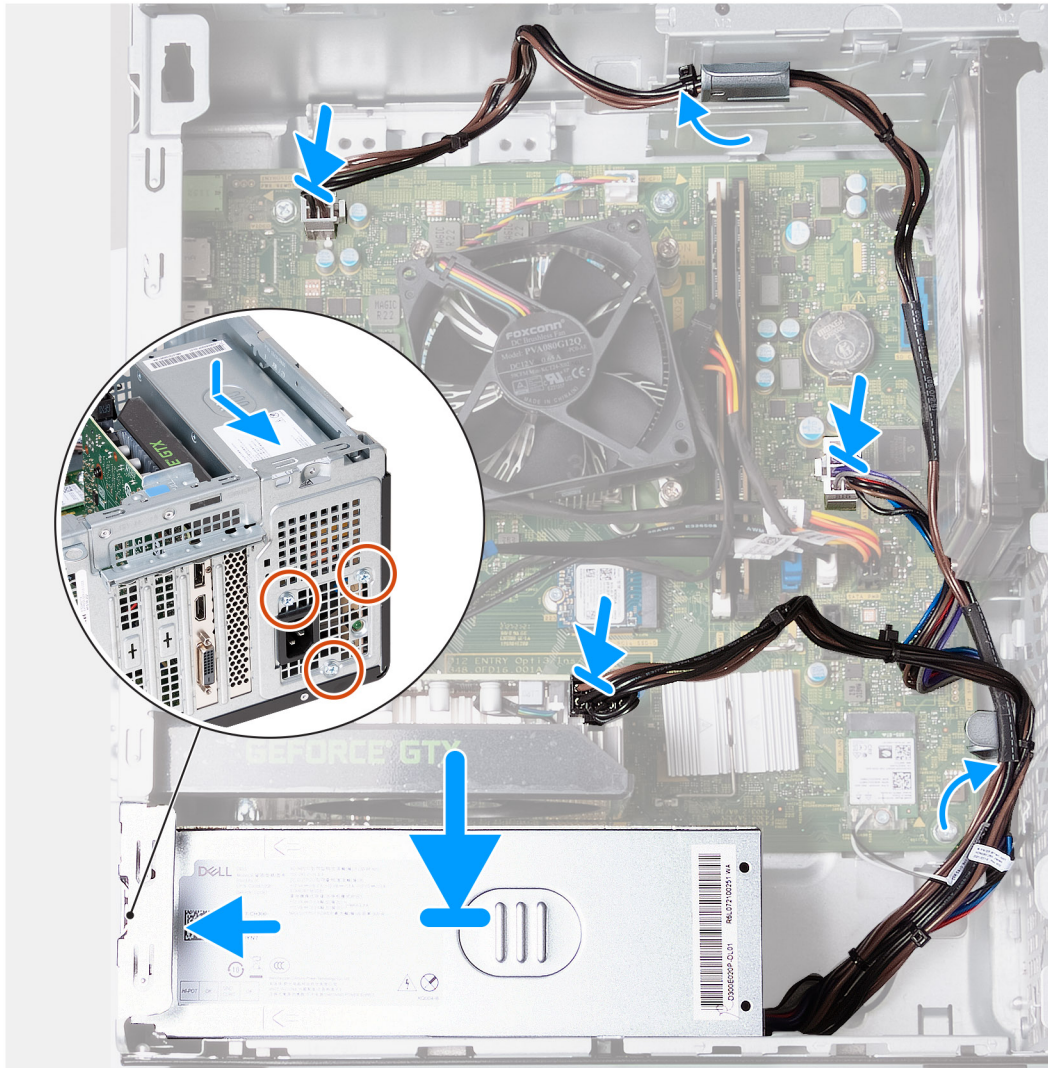

**Figure 37. Installing the power-supply unit**

### Steps

1. Place and slide the tabs on the power-supply unit into the latches on the chassis.
2. Align the screw holes on the power-supply unit to the screw holes on the chassis.
3. Replace the three screws (#6-32) that secure the power-supply unit to the chassis.
4. Route the power-supply unit cables through the routing guides on the chassis.
5. Connect the system-board power cable to the system board.
6. Connect the processor-power cable to the system board.
7. Connect the graphics-card power cable to the graphics card.
8. Place the computer in an upright position.

**Next steps**

1. Install the [left-side cover](#).
2. Follow the procedure in [After working inside your computer](#).

# Removing and installing Field Replaceable Units (FRUs)

The replaceable components in this chapter are Field Replaceable Units (FRUs).

**CAUTION:** The information in this removing and installing FRUs section is intended for authorized service technicians only.

**CAUTION:** To avoid any potential damage to the component or loss of data, ensure that an authorized service technician replaces the Field Replaceable Units (FRUs).

**CAUTION:** Dell Technologies recommends that this set of repairs, if needed, to be conducted by trained technical repair specialists.

**CAUTION:** As a reminder, your warranty does not cover damages that may occur during the courses of FRU repairs that are not authorized by Dell Technologies.

**NOTE:** The images in this document may differ from your computer depending on the configuration you ordered.

## Antenna modules

### Removing the antenna modules

**CAUTION:** The information in this section is intended for authorized service technicians only.

#### Prerequisites

1. Follow the procedure in [Before working inside your computer](#).
2. Remove the [left-side cover](#).
3. Remove the [front cover](#).
4. Remove the [wireless card](#).

#### About this task

The following image indicates the location of the antenna modules and provides a visual representation of the removal procedure.





2x  
M3

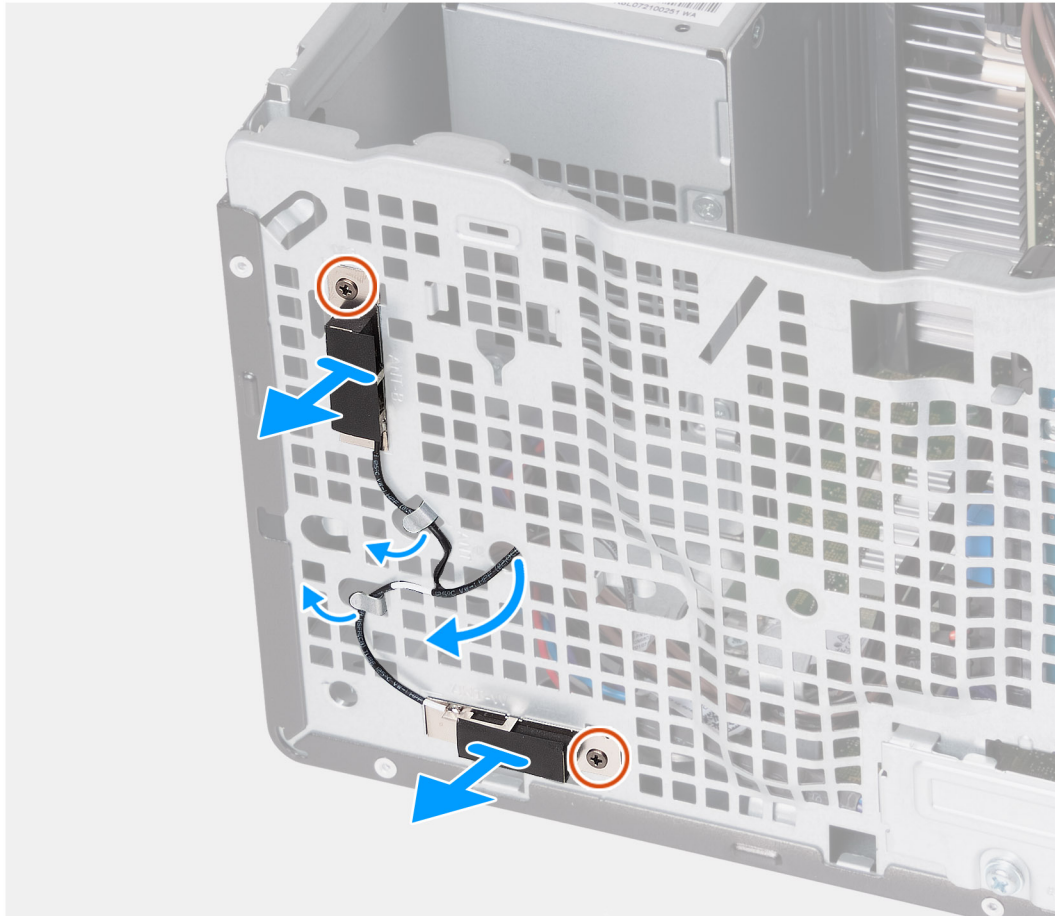

**Figure 38. Removing the antenna modules**

### Steps

1. Loosen the two captive screws (M3) that secure the antenna modules to the chassis.
2. Remove the antenna cables through the routing guide on the chassis and unroute the antenna cables through the slot on the chassis.
3. Lift the antenna module along with its cables off the chassis.

## Installing the antenna modules

**⚠ CAUTION:** The information in this section is intended for authorized service technicians only.

### Prerequisites

If you are replacing a component, remove the existing component before performing the installation process.

### About this task

The following image indicates the location of the antenna modules and provides a visual representation of the installation procedure.

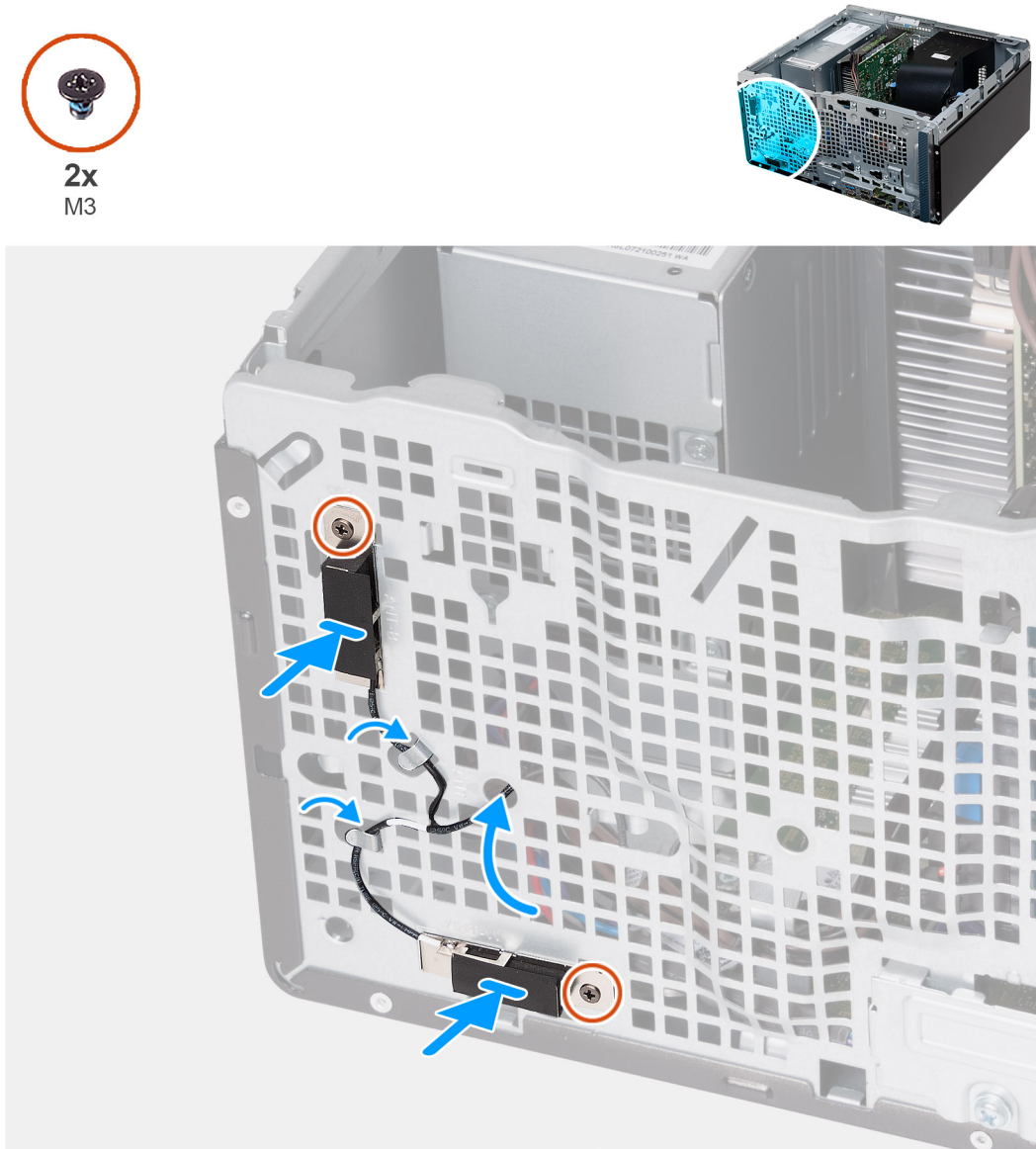

**Figure 39. Installing the antenna modules**

### Steps

1. Place the antenna modules on the chassis.
2. Align the captive screws on the antenna modules with the screw holes on the chassis.
3. Tighten the two captive screws (M3) that secure the antenna modules to the chassis.
4. Route the antenna cables through the slot on the chassis and route the antenna cables through the routing guides on the chassis.

### Next steps

1. Install the [wireless card](#).
2. Install the [front cover](#).
3. Install the [left-side cover](#).
4. Follow the procedure in [After working inside your computer](#).

# Processor fan and heat-sink assembly

## Removing the processor fan and heat-sink assembly

**CAUTION:** The information in this section is intended for authorized service technicians only.

### Prerequisites

1. Follow the procedure in [Before working inside your computer](#).
2. Remove the [left-side cover](#).
3. Remove the [fan shroud](#).

### About this task

**WARNING:** The heat sink may become hot during normal operation. Allow sufficient time for the heat sink to cool before you touch it.

**CAUTION:** For maximum cooling of the processor, do not touch the heat transfer areas on the heat sink. The oils in your skin can reduce the heat transfer capability of the thermal grease.

The following image indicates the location of the processor fan and heat-sink assembly and provides a visual representation of the removal procedure.

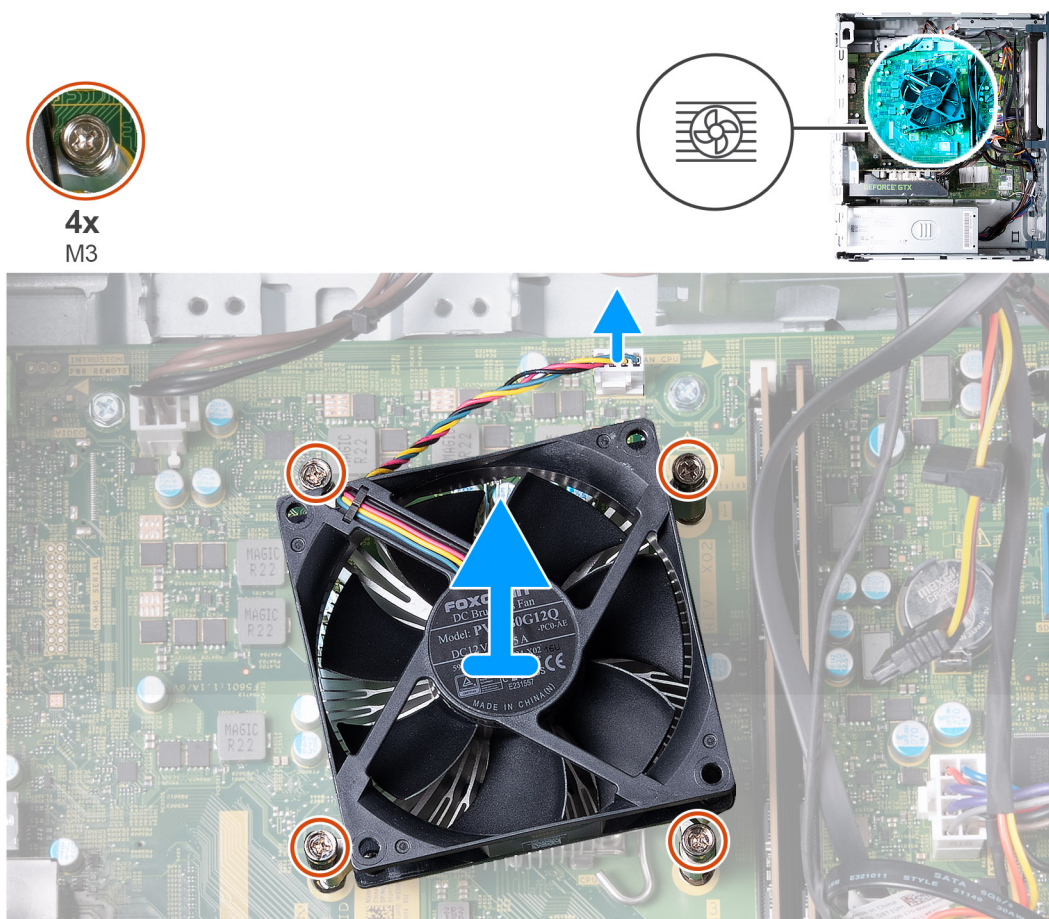

Figure 40. Removing the processor fan and heat-sink assembly

### Steps

1. Disconnect the fan cable from the system board.

2. In a reverse sequential order (4>3>2>1) loosen the four captive screws (M3) that secure the processor fan and heat-sink assembly to the system board.
3. Lift the processor fan and heat-sink assembly from the system board.

## Installing the processor fan and heat-sink assembly

**CAUTION:** The information in this section is intended for authorized service technicians only.

### Prerequisites

If you are replacing a component, remove the existing component before performing the installation process.

### About this task

**NOTE:** If either the processor or the fan and heat-sink assembly is replaced, use the thermal grease that is provided in the kit to ensure that the thermal conductivity is achieved.

The following image indicates the location of the processor fan and heat-sink assembly and provides a visual representation of the installation procedure.

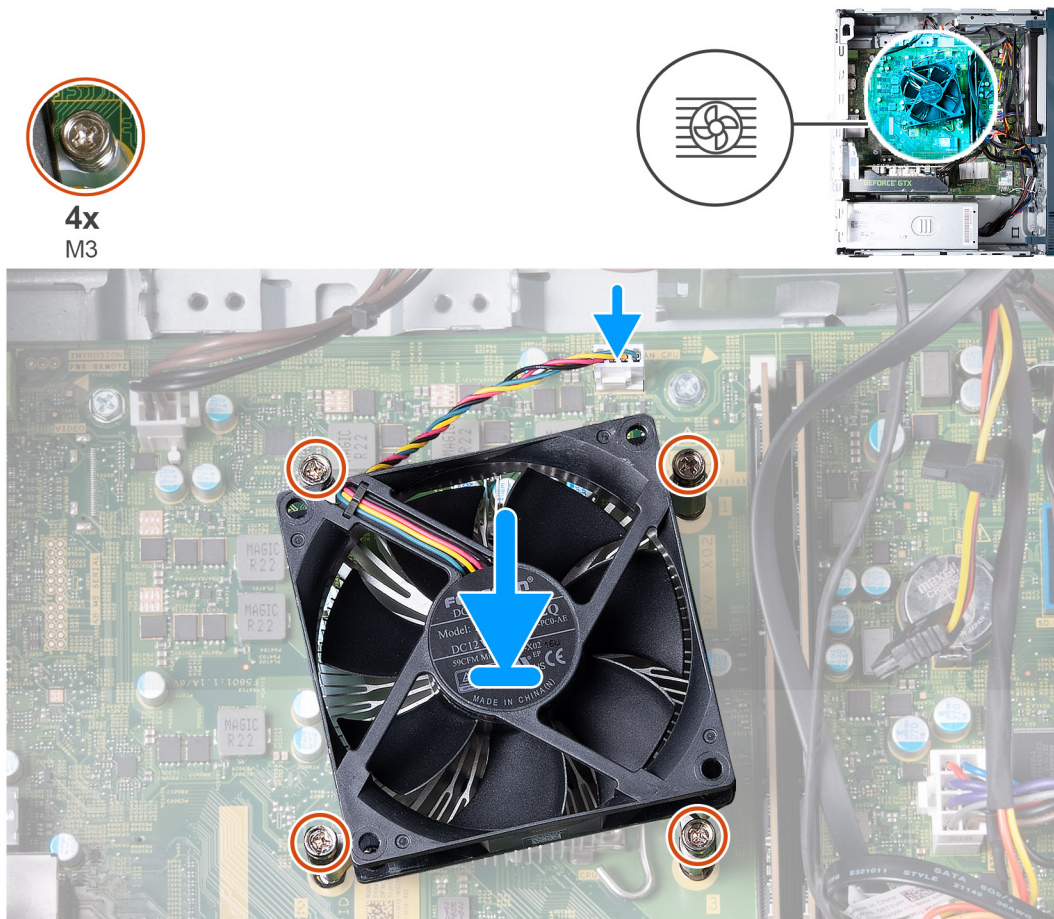

**Figure 41. Installing the processor fan and heat-sink assembly**

### Steps

1. Gently place the processor fan and heat-sink assembly on the processor.
2. Align the screw holes on the processor fan and heat-sink assembly with the screw holes on the system board.
3. In sequential order (1>2>3>4) tighten the four captive screws that secure the processor fan and heat-sink assembly to the system board.
4. Connect the fan cable to the system board.

### Next steps

1. Install the [fan shroud](#).
2. Install the [left-side cover](#).
3. Follow the procedure in [After working inside your computer](#).

## Processor

### Removing the processor

**CAUTION:** The information in this section is intended for authorized service technicians only.

#### Prerequisites

1. Follow the procedure in [Before working inside your computer](#).
2. Remove the [left-side cover](#).
3. Remove the [fan shroud](#).
4. Remove the [processor fan and heat-sink assembly](#).

#### About this task

**WARNING:** The heat sink may become hot during normal operation. Allow sufficient time for the heat sink to cool before you touch it.

**CAUTION:** For maximum cooling of the processor, do not touch the heat transfer areas on the heat sink. The oils in your skin can reduce the heat transfer capability of the thermal grease.

The following image indicates the location of the processor and provides a visual representation of the removal procedure.

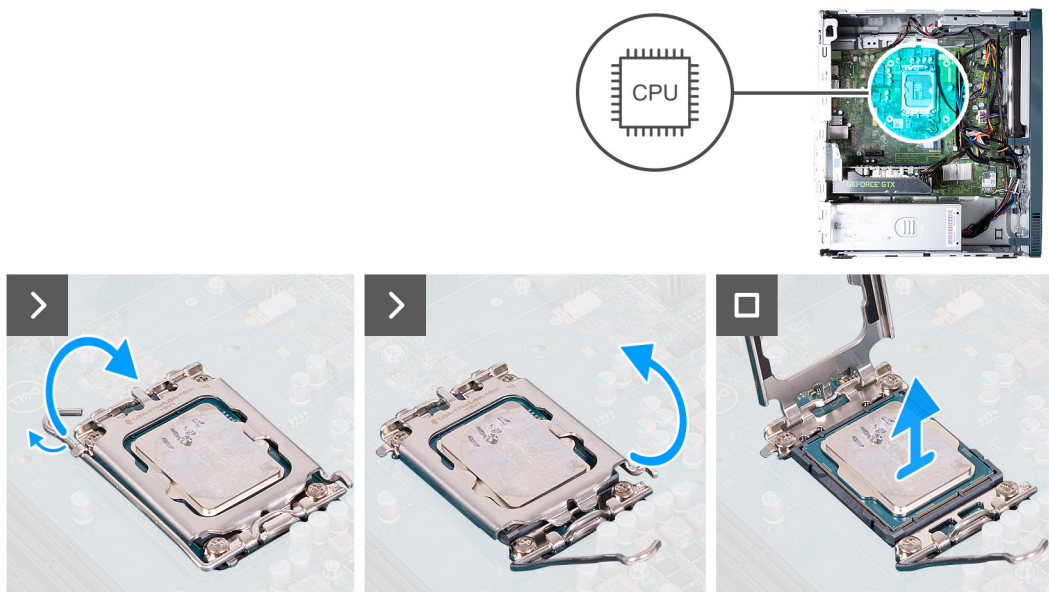

Figure 42. Removing the processor

#### Steps

1. Press the release lever down and then push it away from the processor to release it from the securing tab.
2. Extend the release lever completely and open the processor cover.

**CAUTION:** When removing the processor, do not touch any of the pins inside the socket or allow any objects to fall on the pins in the socket.

3. Gently lift the processor from the processor socket.

# Installing the processor

**CAUTION:** The information in this section is intended for authorized service technicians only.

## Prerequisites

If you are replacing a component, remove the existing component before performing the installation process.

## About this task

The following image indicates the location of the processor and provides a visual representation of the installation procedure.

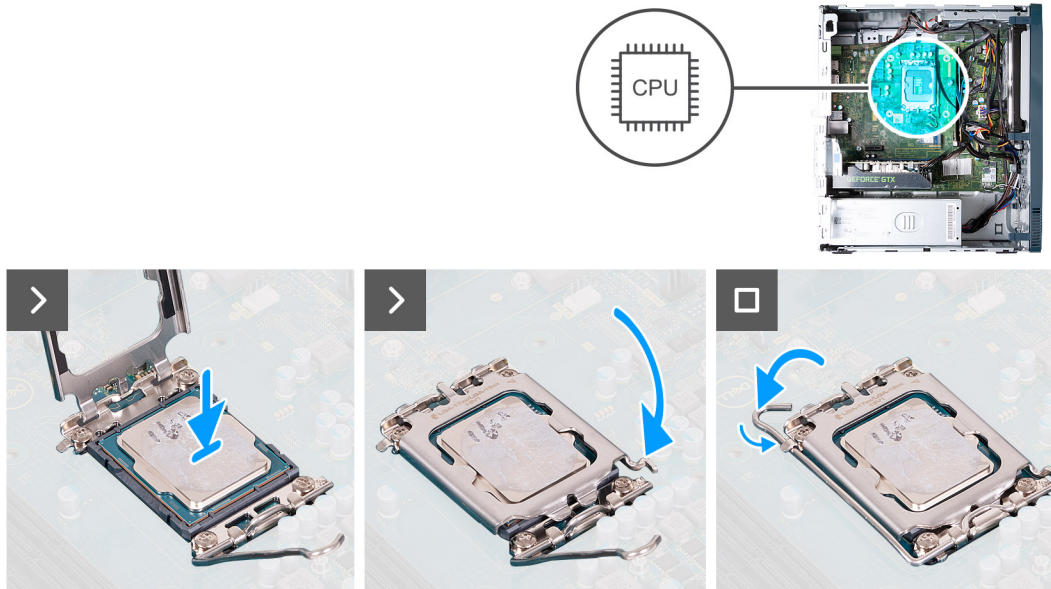

**Figure 43. Installing the processor**

## Steps

1. Ensure that the release lever and the processor cover are fully extended in the open position.
  - NOTE:** The pin 1 corner of the processor has a triangle that aligns with the triangle on the pin 1 corner on the processor socket. When the processor is properly seated, all four corners are aligned at the same height. If one or more corners of the processor are higher than the others, the processor is not seated properly.
2. Align the notches on the processor with the tabs on the processor socket and place the processor in the processor socket.
  - CAUTION:** Ensure the tabs on the processor cover are placed under the notch of the release lever.
3. Close the processor cover, pivot the release lever down, and place it under the tab on the processor socket.

## Next steps

1. Install the [processor fan and heat-sink assembly](#).
2. Install the [fan shroud](#).
3. Install the [left-side cover](#).
4. Follow the procedure in [After working inside your computer](#).

# Optional Input/Output modules

## Serial module

### Removing the optional serial module

**CAUTION:** The information in this section is intended for authorized service technicians only.

#### Prerequisites

1. Follow the procedure in [Before working inside your computer](#).
2. Remove the [side cover](#).
3. Remove the [fan shroud](#).

#### About this task

The following image indicates the location of the optional serial module and provides a visual representation of the removal procedure.

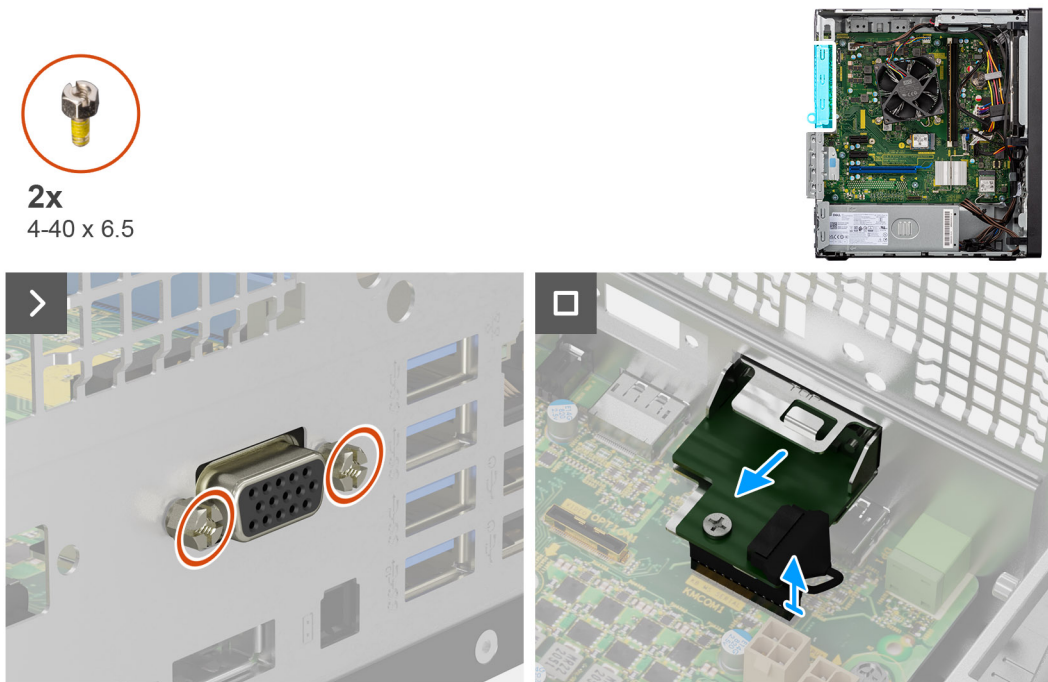

Figure 44. Removing the optional serial module

#### Steps

1. Remove the two (4-40x6.5) screws that secure the optional serial module to the chassis.
2. Disconnect the optional serial module cable from the connector on the system board.
3. Lift the optional serial module off the system board.

## Installing the serial module

**CAUTION:** The information in this section is intended for authorized service technicians only.

#### Prerequisites

If you are replacing a component, remove the existing component before performing the installation procedure.

## About this task

The following image indicates the location of the serial module and provides a visual representation of the installation procedure.

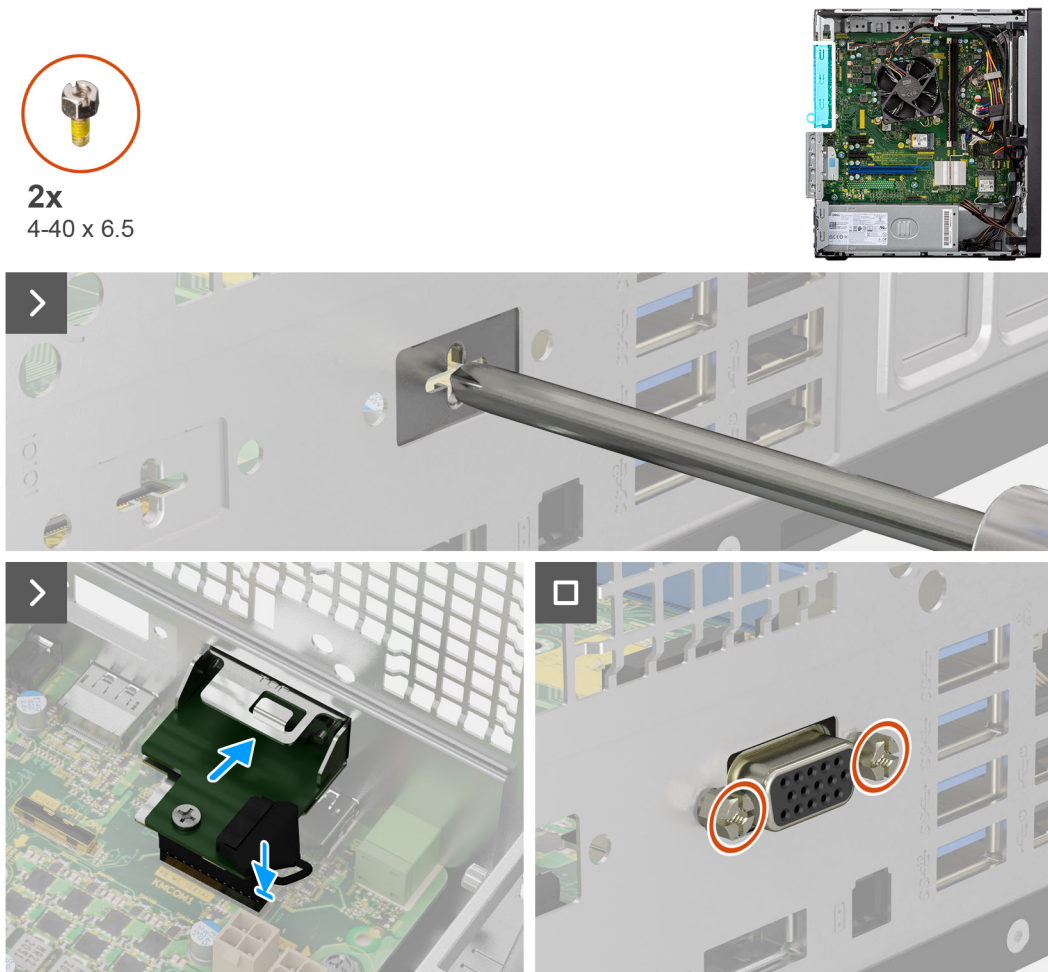

**Figure 45. Installing the serial module**

### Steps

1. Using a screwdriver, remove the serial module cover from the chassis.  
**i** **NOTE:** This step is applicable only when the serial module is being installed for the first time.
2. Connect the serial-module cable to the connector (KB\_MS\_SERIAL) on the system board.
3. Insert the serial module into the slot on the chassis.
4. Replace the two (4-40x6.5) screws that secure the serial module to the chassis.

### Next steps

1. Install the [fan shroud](#).
2. Install the [side cover](#).
3. Follow the procedure in [after working inside your computer](#).

## VGA module

### Removing optional VGA module

**⚠ CAUTION:** The information in this section is intended for authorized service technicians only.



### Prerequisites

1. Follow the procedure in [before working inside your computer](#).
2. Remove the [side cover](#).
3. Remove the [fan shroud](#).

### About this task

The following image indicates the location of the optional VGA module and provides a visual representation of the removal procedure.

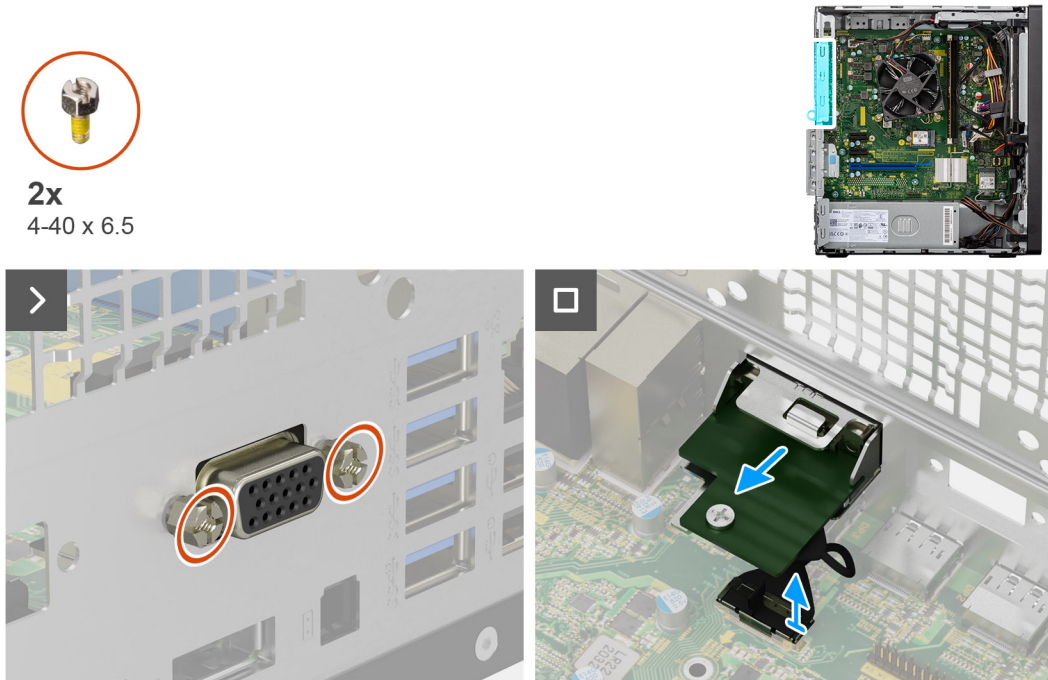

**Figure 46. Removing optional VGA module**

### Steps

1. Remove the two (4-40x6.5) screws that secure the optional VGA module to the computer chassis.
2. Disconnect the VGA module cable from the connector on the system board.
3. Remove the VGA module from the computer.

## Installing optional VGA module

**CAUTION:** The information in this section is intended for authorized service technicians only.

### Prerequisites

If you are replacing a component, remove the existing component before performing the installation procedure.

### About this task

The following image indicates the location of the optional VGA module and provides a visual representation of the installation procedure.



2x  
4-40 x 6.5

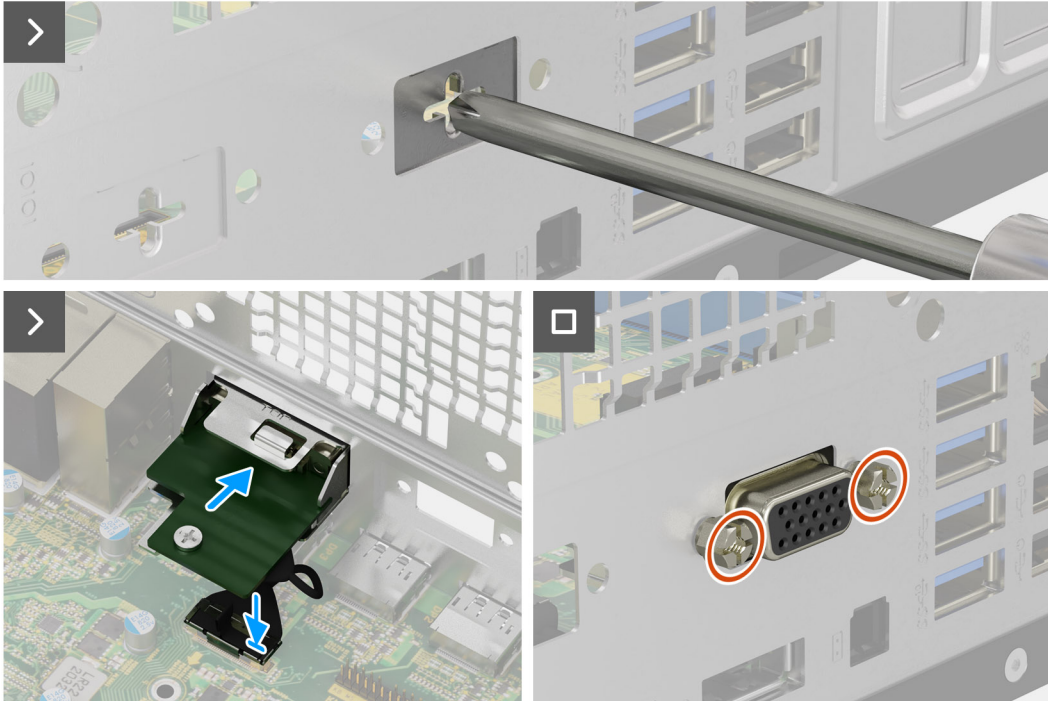

Figure 47. Installing optional VGA module

### Steps

1. To remove the dummy metal bracket, insert a star-head screwdriver in the hole of the bracket, push the bracket to release the bracket, and then lift the bracket out from the computer.  
**(i) NOTE:** Applies if you are upgrading the computer that did not have these optional modules.
2. Insert the optional VGA module into its slot from inside your computer.
3. Connect the VGA module cable to the connector on the system board .
4. Replace the two (4-40x6.5) screws to secure the optional VGA module to the computer.

### Next steps

1. Install the [fan shroud](#).
2. Install the [side cover](#).
3. Follow the procedure in [after working inside your computer](#).

## System board

### Removing the system board

**⚠ CAUTION:** The information in this section is intended for authorized service technicians only.

## Prerequisites

1. Follow the procedure in [Before working inside your computer](#).
2. Remove the [left-side cover](#).
3. Remove the [front cover](#).
4. Remove the [memory](#).
5. Remove the [solid-state drive](#).
6. Remove the [hard drive](#).
7. Remove the [graphics card](#).
8. Remove the [wireless card](#).
9. Remove the [coin-cell battery](#).
10. Remove the [media-card reader](#).
11. Remove the [fan shroud](#).
12. Remove the [Serial module](#), if applicable.
13. Remove the [VGA module](#), if applicable.
14. Remove the [fan and heat-sink assembly](#).
15. Remove the [processor](#).

## About this task

The following image indicates the slots and connectors on your system board.

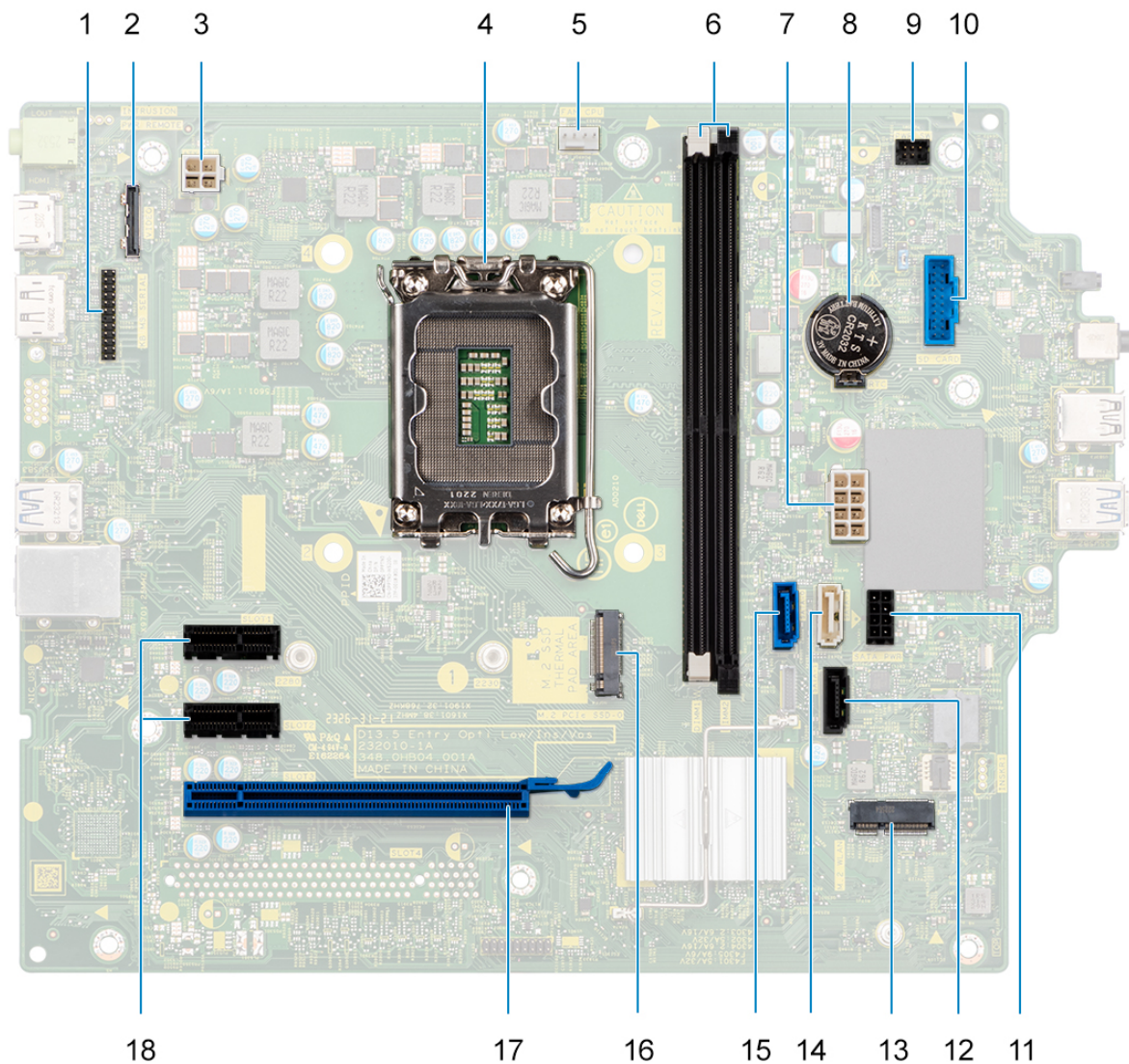
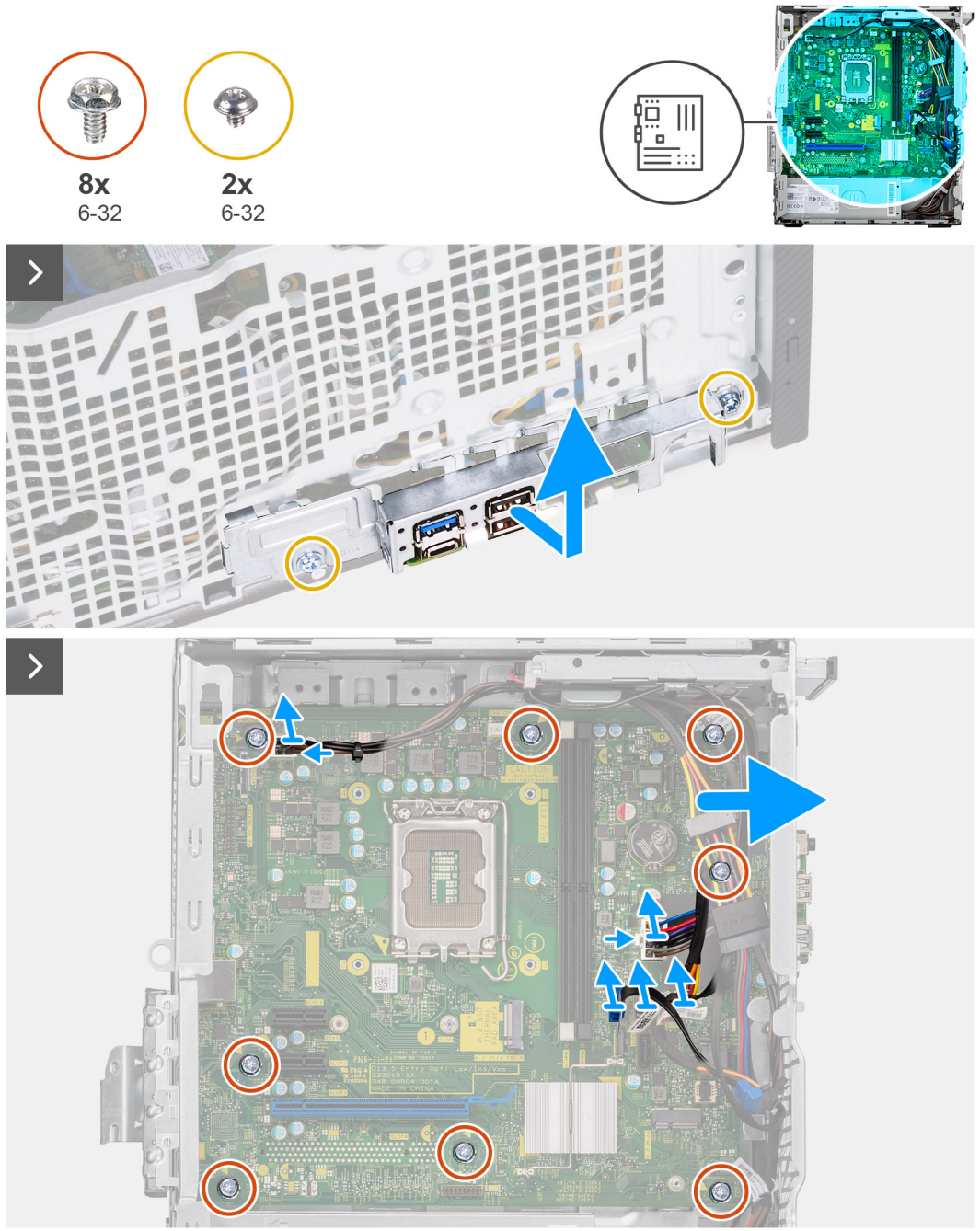

**Figure 48. System board callout**

1. Serial port connector
2. VGA port connector
3. processor-power cable connector
4. Processor socket
5. processor-fan cable connector
6. memory-module slots
7. system-board power cable connector
8. coin-cell battery socket
9. power-button cable connector
10. media-card reader cable connector
11. Hard drive power cable connector
12. optical-drive data cable connector (SATA 3)
13. M.2 2230 wireless-card slot
14. Hard drive data cable connector (SATA 1)

- 15. Hard drive data cable connector (SATA 0, boot drive)
- 16. M.2 2230/2280 solid state drive slot
- 17. PCIe x16 slot (SLOT 3)
- 18. Two PCIe x1 slots (SLOT 2)

The following images indicate the location of the system board and provide a visual representation of the removal procedure.



**Figure 49. Removing the system board**

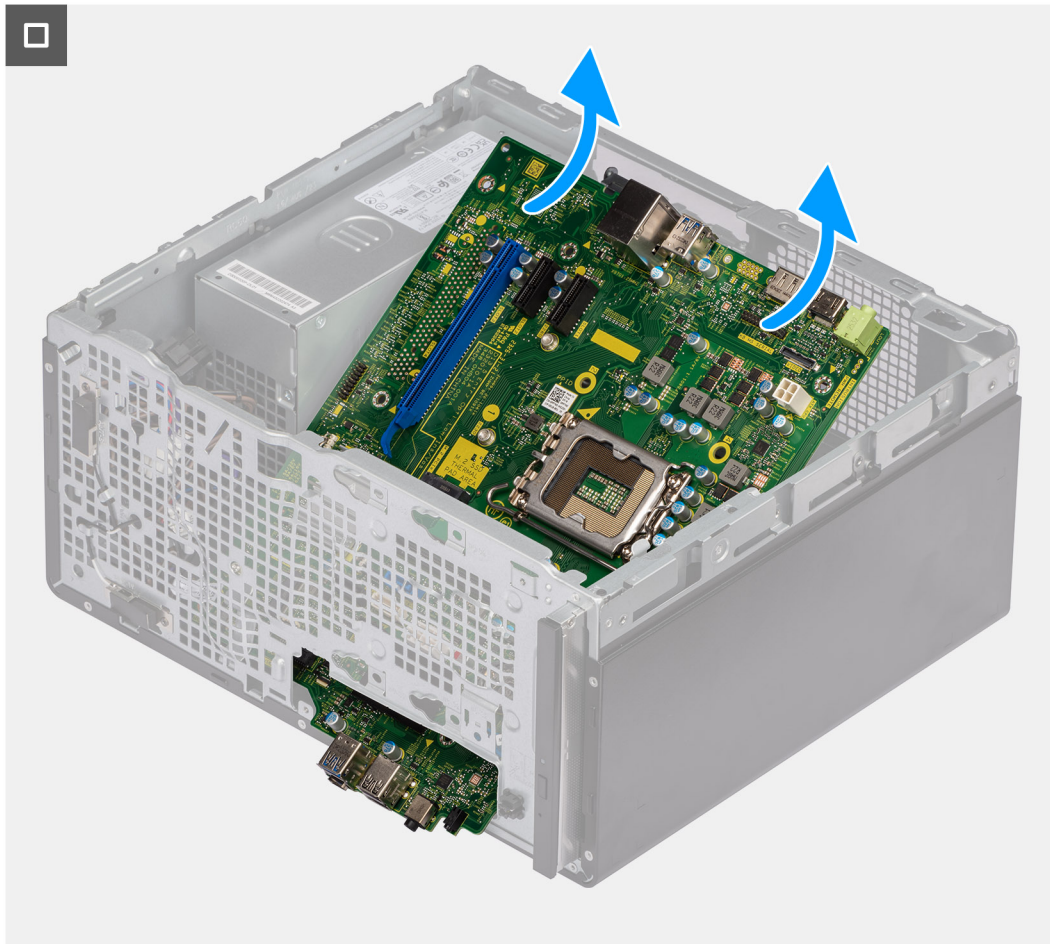

**Figure 50. Removing the system board**

### Steps

1. Remove the two screws (6-32) that secure the front I/O-bracket to the chassis.
2. Remove and lift the front I/O-bracket from the chassis.
3. Disconnect all the cables that are connected to the system board.
  - processor-power cable
  - system-board power cable
  - optical-drive data cable
  - optical-drive power cable
4. Remove the eight screws (6-32) that secure the system board to the chassis.
5. Lift the system board at an angle and remove it from the chassis.

## Installing the system board

**CAUTION:** The information in this section is intended for authorized service technicians only.

### Prerequisites

If you are replacing a component, remove the existing component before performing the installation process.

### About this task

The following image indicates the slots and connectors on your system board.

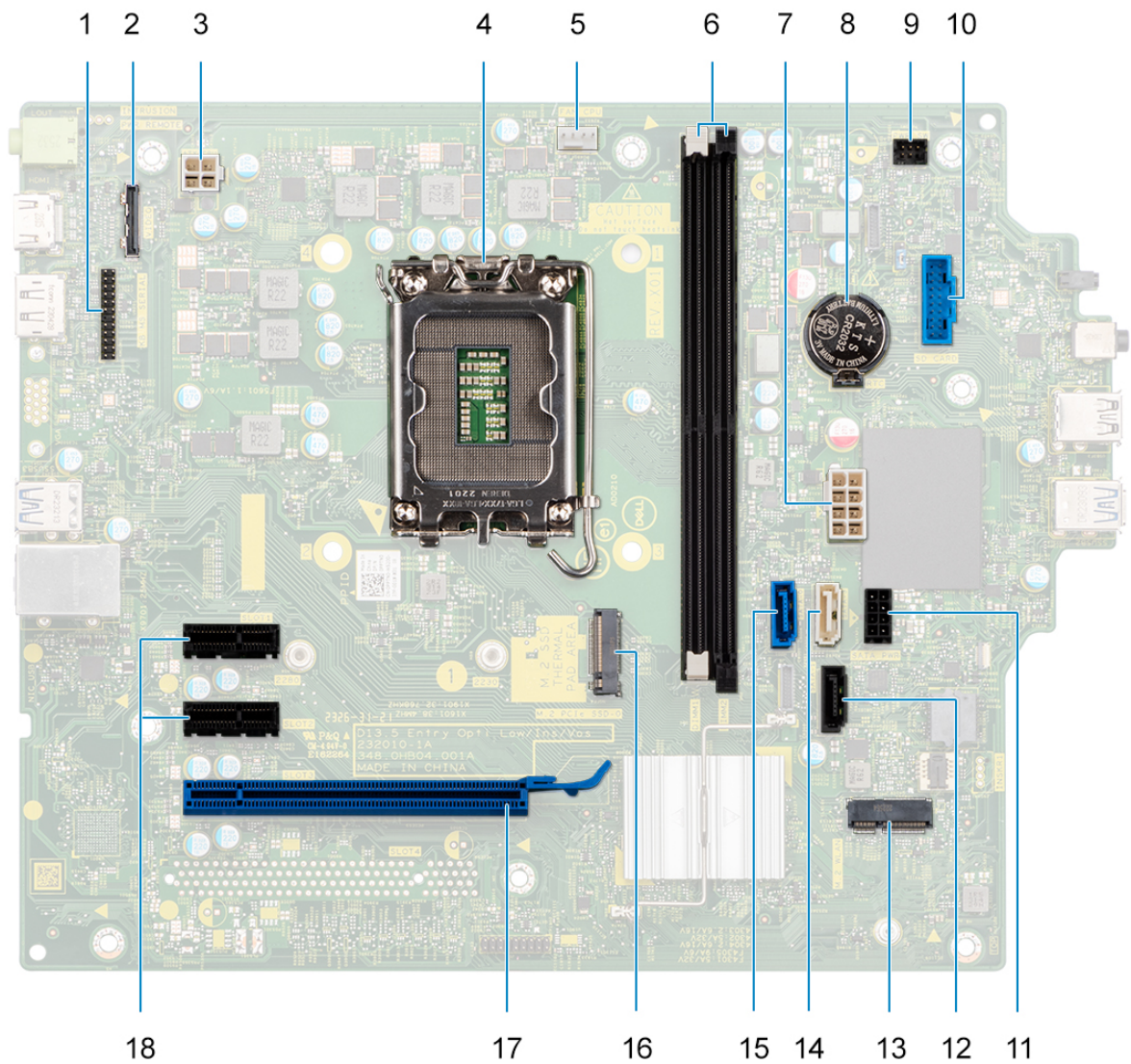
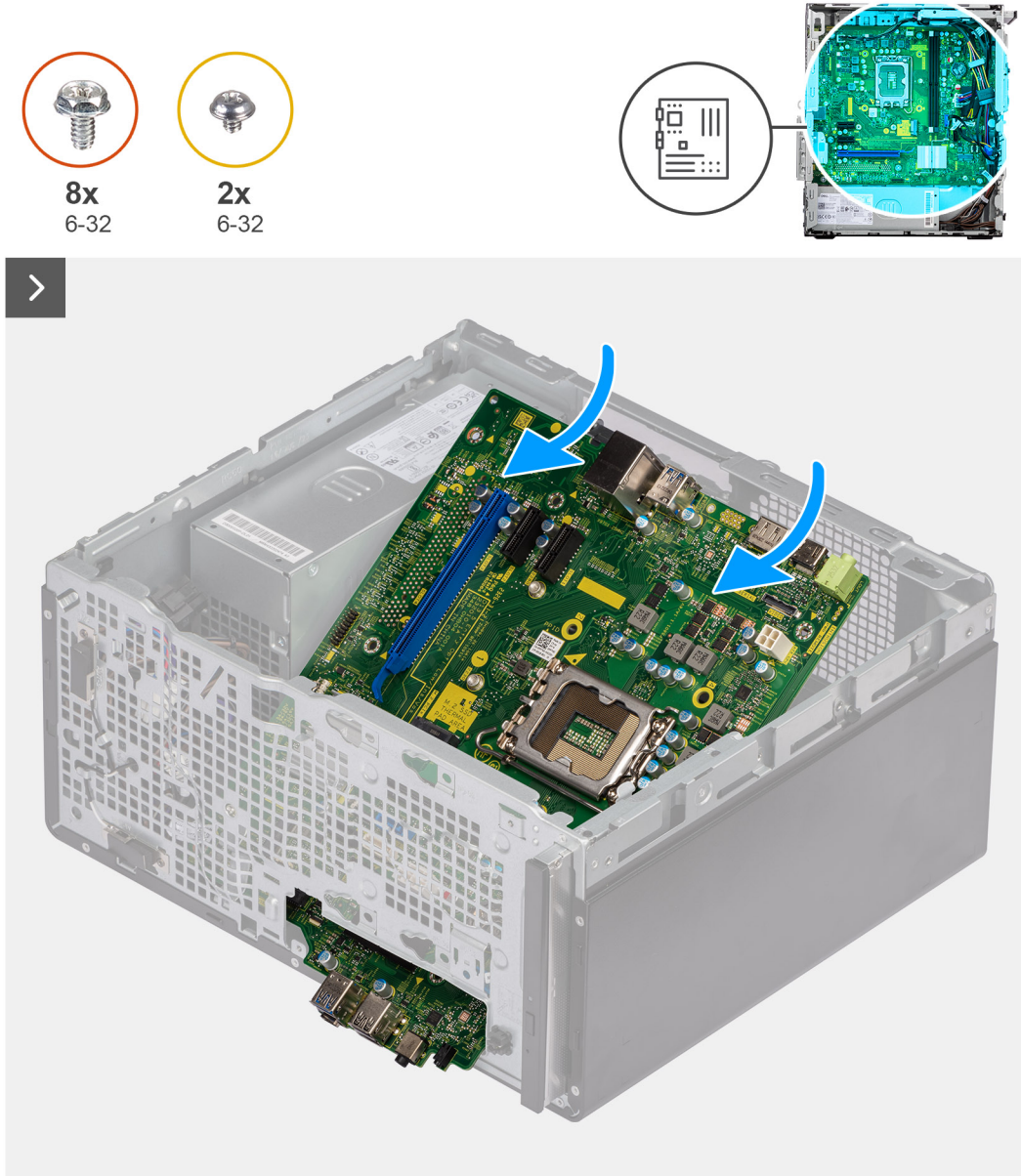

**Figure 51. System board callout**

1. Serial port connector
2. VGA port connector
3. processor-power cable connector
4. Processor socket
5. processor-fan cable connector
6. memory-module slots
7. system-board power cable connector
8. coin-cell battery socket
9. power-button cable connector
10. media-card reader cable connector
11. Hard drive power cable connector
12. optical-drive data cable connector (SATA 3)
13. M.2 2230 wireless-card slot
14. Hard drive data cable connector (SATA 1)

- 15. Hard drive data cable connector (SATA 0, boot drive)
- 16. M.2 2230/2280 solid state drive slot
- 17. PCIe x16 slot (SLOT 3)
- 18. Two PCIe x1 slots (SLOT 2)

The following images indicate the location of the system board and provide a visual representation of the installation procedure.



**Figure 52. Installing the system board**



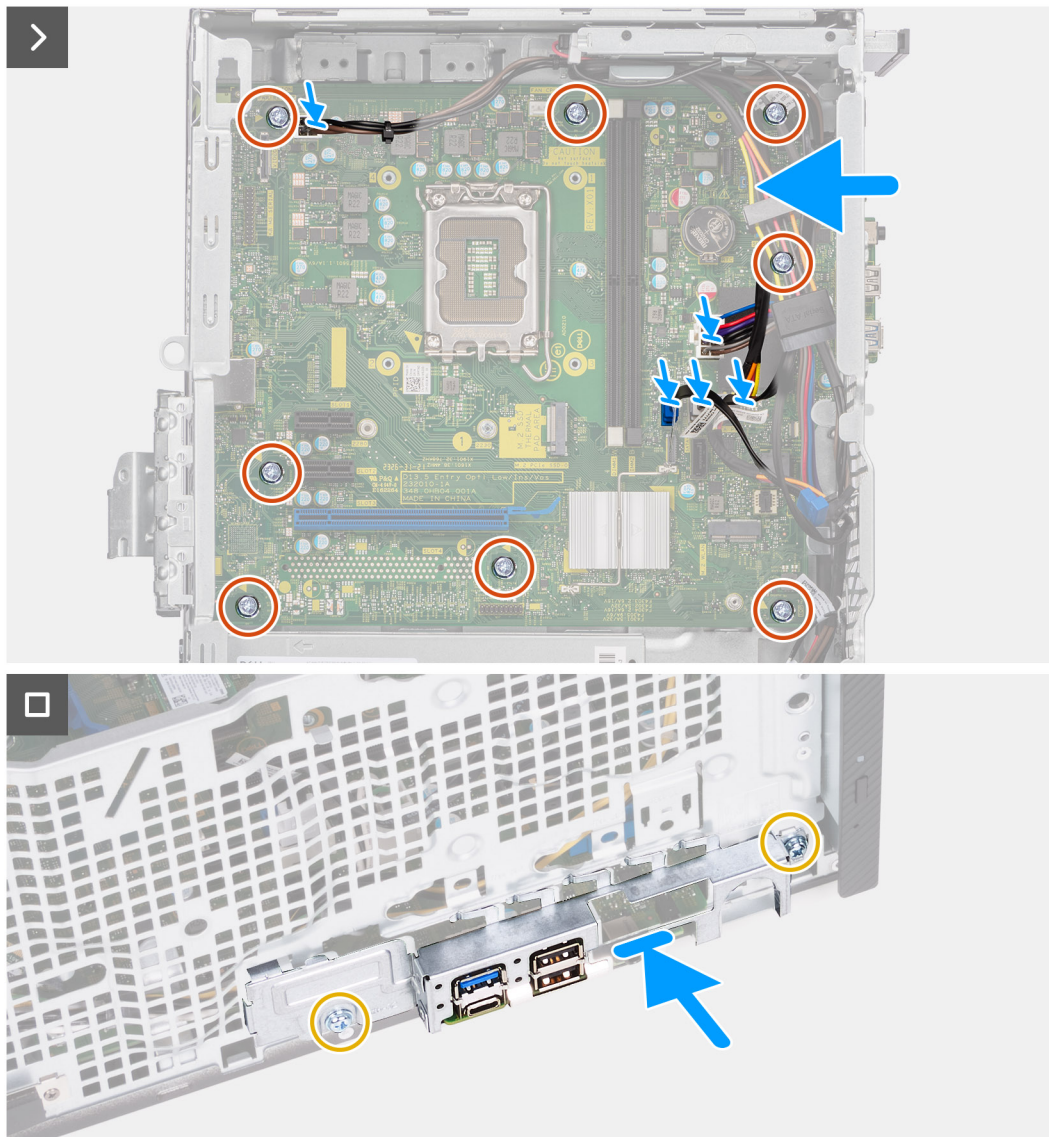

**Figure 53. Installing the system board**

**Steps**

1. Slide the front I/O-ports on the system board into the front I/O-slots on the chassis.
2. Align the screw holes on the system board with the screw holes on the chassis.
3. Replace the eight screws (6-32) that secure the system board to the chassis.
4. Route and connect all the cables that you disconnected from the system board.
  - processor-power cable
  - system-board power cable
  - optical-drive data cable
  - optical-drive power cable
5. Place and align the front I/O-bracket with the I/O slot on the chassis.
6. Replace the two screws (6-32) that secure the front I/O-bracket to the chassis.

**Next steps**

1. Install the [processor](#).
2. Install the [processor fan and heat-sink assembly](#).
3. Install the [serial module](#), if applicable.
4. Install the [VGA module](#), if applicable.

5. Install the [fan shroud](#).
6. Install the [media-card reader](#).
7. Install the [coin-cell battery](#).
8. Install the [wireless card](#).
9. Install the [graphics card](#).
10. Install the [hard drive](#).
11. Install the [solid-state drive](#).
12. Install the [memory](#).
13. Install the [front cover](#).
14. Install the [left-side cover](#).
15. Follow the procedure in [After working inside your computer](#).

# Software

This chapter details the supported operating systems along with instructions on how to install the drivers.

## Operating system

Your Vostro 3030 Desktop supports the following operating systems:

- Windows 11 Home
- Windows 11 Pro
- Windows 11 Home National Education
- Windows 11 Pro National Education
- Ubuntu 22.04 LTS

## Drivers and downloads

When troubleshooting, downloading, or installing drivers, it is recommended that you read the Dell Knowledge Base article, Drivers and Downloads FAQs [000123347](#).

# BIOS Setup

**CAUTION:** Unless you are an expert computer user, do not change the settings in the BIOS Setup. Certain changes can make your computer work incorrectly.

**NOTE:** Depending on the computer and its installed devices, the items that are listed in this section may or may not be displayed.

**NOTE:** Before you change the settings in BIOS Setup, it is recommended that you note down the original settings for future reference.

Use BIOS Setup for the following purposes:

- Get information about the hardware installed in your computer, such as the amount of RAM and the size of the hard drive.
- Change the system configuration information.
- Set or change a user-selectable option, such as the user password, type of hard drive installed, and enabling or disabling base devices.

## Entering BIOS setup program

### About this task

Turn on (or restart) your computer and press F2 immediately.

## Navigation keys

**NOTE:** For most of the System Setup options, changes that you make are recorded but do not take effect until you restart the computer.

**Table 23. Navigation keys**

Keys	Navigation
Up arrow	Moves to the previous field.
Down arrow	Moves to the next field.
Enter	Selects a value in the selected field (if applicable) or follow the link in the field.
Spacebar	Expands or collapses a drop-down list, if applicable.
Tab	Moves to the next focus area. <b>NOTE:</b> For the standard graphics browser only.
Esc	Moves to the previous page until you view the main screen. Pressing Esc in the main screen displays a message that prompts you to save any unsaved changes and restarts the computer.

## Boot sequence

Boot sequence allows you to bypass the System Setup–defined boot device order and boot directly to a specific device (for example: optical drive or hard drive). During the Power-on Self Test (POST), when the Dell logo appears, you can:

- Access System Setup by pressing F2 key
- Bring up the one-time boot menu by pressing F12 key

The one-time boot menu displays the devices that you can boot from including the diagnostic option. The boot menu options are:

- Removable Drive (if available)
- STXXXX Drive (if available)
  - **i** **NOTE:** XXX denotes the SATA drive number.
- Optical Drive (if available)
- SATA Hard Drive (if available)
- Diagnostics

The boot sequence screen also displays the option to access the System Setup screen.

## F12 One Time Boot menu

To enter the One Time Boot menu, turn on your computer, and then press F12 immediately.

**i** **NOTE:** It is recommended to shut down the computer, if it is on.

The F12 One Time Boot menu displays the devices that you can boot from including the diagnostic option. The boot menu options are:

- Removable Drive (if available)
- STXXXX Drive (if available)
  - **i** **NOTE:** XXX denotes the SATA drive number.
- Optical Drive (if available)
- SATA Hard Drive (if available)
- Diagnostics

The boot sequence screen also displays the option to access System Setup.

## System setup options

**i** **NOTE:** Depending on this computer and its installed devices, the items that are listed in this section may or may not appear.

**Table 24. System setup options—System information menu**

Overview	
<b>Vostro 3030</b>	
BIOS Version	Displays the BIOS version number.
Service Tag	Displays the Service Tag of the computer.
Asset Tag	Displays the Asset Tag of the computer.
Manufacture Date	Displays the manufacture date of the computer.
Ownership Date	Displays the ownership date of the computer.
Express Service Code	Displays the express service code of the computer.
Ownership Tag	Displays the ownership tag of the computer.
Signed Firmware Update	Displays whether the signed firmware update is enabled.
<b>PROCESSOR</b>	
Processor Type	Displays the processor type.
Maximum Clock Speed	Displays the maximum processor clock speed.
Minimum Clock Speed	Displays the minimum processor clock speed.

**Table 24. System setup options—System information menu (continued)**

<b>Overview</b>	
Current Clock Speed	Displays the current processor clock speed.
Core Count	Displays the number of cores on the processor.
Processor ID	Displays the processor identification code.
Processor L2 Cache	Displays the Processor L2 Cache size.
Processor L3 Cache	Displays the Processor L2 Cache size.
Microcode Version	Displays the microcode version of the processor.
Intel® Hyper-Threading Capable	Displays whether the processor is Hyper-Threading (HT) capable.
64-Bit Technology	Displays whether 64-bit technology is used.
<b>MEMORY</b>	
Memory Installed	Displays the total computer memory installed.
Memory Available	Displays the total computer memory available.
Memory Speed	Displays the memory speed.
Memory Channel Mode	Displays single or dual channel mode.
Memory Technology	Displays the technology used for the memory.
DIMM 1 Size	Displays the DIMM 1 memory size.
DIMM 2 Size	Displays the DIMM 2 memory size.
<b>DEVICES</b>	
Video Controller	Displays the video controller type of the computer.
Video Memory	Displays the video memory information of the computer.
Wi-Fi Device	Displays the wireless device information of the computer.
Native Resolution	Displays the native resolution of the computer.
Video BIOS Version	Displays the video BIOS version of the computer.
Audio Controller	Displays the audio controller information of the computer.
Bluetooth Device	Displays the Bluetooth device information of the computer.
LOM MAC Address	Displays the LOM MAC address of the computer.
Slot 2	Displays the status of the expansion slot (Slot 2) of the computer.
Slot 3	Displays the status of the expansion slot (Slot 3) of the computer.

**Table 25. System setup options—Boot Configuration menu**

<b>Boot Configuration</b>	
<b>Boot Sequence</b>	
Boot Mode: UEFI only	Displays the boot mode of this computer.
Boot Sequence	Specifies the order that the BIOS searches the list of devices to find an operating system to boot.  By default, UEFI Hard Drive 2 is selected. By default, Windows Boot Manager is selected. By default, UEFI Hard Drive is selected. By default, ONBOARD NIC (IPV4) is selected. By default, ONBOARD NIC (IPV6) is selected. By default, UEFI HTTPS Boost is selected.

**Table 25. System setup options—Boot Configuration menu (continued)**

<b>Boot Configuration</b>	
<b>Secure Boot</b>	
Enable Secure Boot	Enables secure boot using only validated boot software. Default: OFF
Secure Boot Mode	Modifies the behavior of Secure Boot to allow evaluation or enforcement of UEFI driver signatures. Deployed Mode should be selected for normal operation of Secure Boot. By default, Deployed Mode is selected.
<b>Expert Key Management</b>	
Enable Custom Mode	Allows the PK, KEK, db, and dbx security key databases to be modified. Default: OFF <b>NOTE:</b> If Custom Mode is not enabled, any changes that are made with respect to the keys will not be saved.
Custom Mode Key Management	Allows for selection of key database. <ul style="list-style-type: none"> <li>• Save to File will save the key to a user-selected file.</li> <li>• Replace from File will replace the current key with a key from a user-selected file.</li> <li>• Append from File will add a key to the current database from a user-selected file.</li> <li>• Delete will delete the selected key.</li> <li>• Reset All Keys will reset all four keys to their default settings.</li> </ul> By default, PK security key database is selected. By default, Save to File is selected.

**Table 26. System setup options—Integrated Devices menu**

<b>Integrated Devices</b>	
<b>Date/Time</b>	
Date	Sets the computer date in MM/DD/YYYY format. Changes to the date take effect immediately.
Time	Sets the computer time in HH/MM/SS 24-hour format. You can switch between a 12-hour and 24-hour clock. Changes to the time take effect immediately.
<b>Camera</b>	
Enable Camera	Enables or disables the camera. By default, Enable Camera is selected.
<b>Audio</b>	
	Enables or disables all integrated audio controller. Default: ON
Enable Microphone	Enables or disables the microphone. By default, Enable Microphone is selected.
Enable Internal Speaker	Enables or disables the internal speaker. By default, Enable Internal Speaker is selected.
<b>USB Configuration</b>	
	Enables or disables booting from USB mass storage devices such as external hard drive, optical drive, and USB drive. By default, Enable Front USB Ports is selected. By default, Enable Rear USB Ports is selected.

**Table 26. System setup options—Integrated Devices menu (continued)**

Integrated Devices	
<b>Front USB Configuration</b>	<p>By default, Enable USB Boot Support is selected.</p> <p>Enables or disables individual USB ports.</p> <p>By default, Front Port 1 (Bottom Left)* is selected.</p> <p>By default, Front Port 2 (Bottom Right)* is selected.</p> <p>By default, Front Port 3 (Top Left) is selected.</p> <p>By default, Front Port 5 (Top Right) is selected.</p> <p>* Denotes a USB 3.0-capable port</p> <p><b>i</b> <b>NOTE:</b> USB keyboard and mouse always work in the BIOS setup irrespective of this setting.</p>
<b>Rear USB Configuration</b>	<p>Enables or disables individual USB ports.</p> <p>By default, Rear Port 1 (Top Left)* is selected.</p> <p>By default, Rear Port 2 (Top Right)* is selected.</p> <p>By default, Rear Port 3 (Bottom Left) is selected.</p> <p>By default, Rear Port 5 (Bottom Right) is selected.</p> <p>* Denotes a USB 3.0-capable port</p> <p><b>i</b> <b>NOTE:</b> USB keyboard and mouse always work in the BIOS setup irrespective of this setting.</p>

**Table 27. System setup options—Storage menu**

Storage	
<b>SATA Operation</b>	<p>SATA Operation</p> <p>Configures the operating mode of the integrated storage device controller.</p> <p>Default: RAID On. The storage device is configured to support RAID. (Intel® Rapid Restore Technology)</p>
<b>Storage Interface</b>	<p>Port Enablement</p> <p>Enables or disables the onboard drives.</p> <p>Default: SATA-0 is ON</p> <p>Default: SATA-1 is ON</p> <p>Default: SATA-3 is ON</p> <p>Default: M.2 PCIe SDD-0 is ON</p>
<b>SMART Reporting</b>	<p>Enable or disable SMART Reporting during system startup.</p> <p>Default: OFF</p>
<b>Drive Information</b>	<p>Displays the information of various onboard drives.</p>
<b>Enable MediaCard</b>	<p>Turn on or off all media cards, or enable or disable the media card in read-only state.</p> <p>By default, Secure Digital (SD) Card is selected.</p>

**Table 28. System setup options—Display menu**

Display
<b>Primary Display</b>



**Table 28. System setup options—Display menu (continued)**

<b>Display</b>	
Video Primary Display	Set or change the primary video controller when multi controllers are available in the system. By default, Auto is selected.
Brightness on battery power	Sets the screen brightness when the computer is running on battery power. Default: 50
<b>Full Screen Logo</b>	
Full Screen Logo	Displays the full screen logo if the screen resolution matches the image of the logo. Default: OFF

**Table 29. System setup options—Connection menu**

<b>Connection</b>	
<b>Network Controller Configuration</b>	
Integrated NIC	Controls the onboard LAN controller. By default, Enable with PXE is selected.
<b>Wireless Device Enable</b>	
WLAN	Enables or disables the internal WLAN device. Default: ON
Bluetooth®	Enables or disables the internal Bluetooth® device. Default: ON
<b>Enable UEFI Network Stack</b>	
Enable UEFI Network Stack	Enable or disable UEFI Network Stack. Default: ON
<b>HTTP(s) Boot Feature</b>	
HTTP(s) Boot	Enables or disables the internal speaker. By default, Enable Internal Speaker is selected.
HTTP(s) Boot Modes	Enables or disables HTTP(s) Boot Feature. Default: ON
HTTP(s) Boot Modes	Configure the HTTP(s) Boot Mode. Auto Mode will extract Boot URL from the Dynamic Host Configuration Protocol (DHCP). Manual mode reads user-provided Boot URL. By default, Auto Mode is selected.

**Table 30. System setup options—Power menu**

<b>Power</b>	
<b>USB Wake Support</b>	
Enable USB Wake Support	Enables USB devices like a mouse or keyboard to wake the system from Standby, Hibernation, or Power Off state. Default: ON
<b>AC Behavior</b>	
AC Recovery	Configures the system response when power is restored after an unexpected loss of power.

**Table 30. System setup options—Power menu (continued)**

Power	
	Default: Power OFF is selected. The system stays off after AC power is restored.
<b>Active State Power Management</b>	
ASPM	Configures the Active State Power Management (ASPM) level.  Default: Auto. There is handshaking between the device and PCI Express hub to determine the best ASPM mode supported by the device.
<b>Block Sleep</b>	
Block Sleep	Blocks the computer from entering Sleep (S3) mode in the operating system.  Default: OFF
<b>Deep Sleep Control</b>	
Deep Sleep Control	Configures how aggressive the system is at conserving power while in Shutdown (S5) or Hibernate (S4) mode.  Default: Enabled in S4 and S5
<b>Intel Speed Shift Technology</b>	
Intel Speed Shift Technology	Enables or disables the Intel Speed Shift Technology support. Turning on this option allows the operating system to select the appropriate processor performance automatically.  Default: ON

**Table 31. System setup options—Security menu**

Security	
<b>Trusted Platform Module (TPM)</b>	The Trusted Platform Module (TPM) provides various cryptographic services which serve as the cornerstone for many platform security technologies. Trusted Platform Module (TPM) is a security device that stores computer-generated keys for encryption and features such as BitLocker, Virtual Secure Mode, remote Attestation.  By default, the <b>Trusted Platform Module (TPM)</b> option is enabled.  For additional security, Dell Technologies recommends keeping <b>Trusted Platform Module (TPM)</b> enabled to allow these security technologies to fully function.   <b>NOTE:</b> The options that are listed apply to computers with a discrete <b>Trusted Platform Module (TPM)</b> chip.
TPM On	Allows you to enable or disable TPM.  By default, the <b>TPM On</b> option is enabled.  For additional security, Dell Technologies recommends keeping <b>TPM On</b> enabled to allow these security technologies to fully function.
Physical Presence Interface (PPI) Bypass for Enable Commands	The Physical Presence Interface (PPI) Bypass options can be used to allow the operating system to manage certain aspects of the TPM. If these options are enabled, you are not prompted to confirm certain changes to the TPM configuration.  By default, the <b>PPI Bypass for Enable Commands</b> option is enabled.  For additional security, Dell Technologies recommends keeping the <b>PPI Bypass for Enable Commands</b> option enabled.
Physical Presence Interface (PPI) Bypass for Disable Commands	By default, the <b>PPI Bypass for Disable Commands</b> option is disabled.



**Table 31. System setup options—Security menu (continued)**

Security	
	For additional security, Dell Technologies recommends keeping the <b>PPI Bypass for Disable Commands</b> option disabled.
Physical Presence Interface (PPI) Bypass for Clear Commands	By default, the <b>PPI Bypass for Clear Commands</b> option is disabled. For additional security, Dell Technologies recommends keeping the <b>PPI Bypass for Clear Commands</b> option disabled.
Attestation Enable	The <b>Attestation Enable</b> option controls the endorsement hierarchy of TPM. Disabling the <b>Attestation Enable</b> option prevents TPM from being used to digitally sign certificates. By default, the <b>Attestation Enable</b> option is enabled. For additional security, Dell Technologies recommends keeping the <b>Attestation Enable</b> option enabled. <b>i</b> <b>NOTE:</b> When disabled, this feature may cause compatibility issues or loss of functionality in some operating systems.
Key Storage Enable	The <b>Key Storage Enable</b> option controls the storage hierarchy of TPM, which is used to store digital keys. Disabling the <b>Key Storage Enable</b> option restricts the ability of TPM to store owner's data. By default, the <b>Key Storage Enable</b> option is enabled. For additional security, Dell Technologies recommends keeping the <b>Key Storage Enable</b> option enabled. <b>i</b> <b>NOTE:</b> When disabled, this feature may cause compatibility issues or loss of functionality in some operating systems.
SHA-256	Allows you to control the hashing algorithm that is used by the TPM. When enabled, the TPM uses the SHA-256 hashing algorithm. When disabled, the TPM uses the SHA-1 hash algorithm. By default, the <b>SHA-256</b> option is enabled. For additional security, Dell Technologies recommends keeping the <b>SHA-256</b> option enabled.
Clear	When enabled, the <b>Clear</b> option clears information that is stored in the TPM after exiting the computer's BIOS. This option returns to the disabled state when the computer restarts. By default, the <b>Clear</b> option is disabled. Dell Technologies recommends enabling the <b>Clear</b> option only when TPM data is required to be cleared.
TPM State	Enables or disables the Trusted Platform Module (TPM). This is the normal operating state for the Trusted Platform Module (TPM) when you want to use its complete array of capabilities. By default, the <b>TPM State</b> option is enabled.
<b>Intel® Platform Trust Technology</b>	Intel PTT is a firmware-based Trusted Platform Module (fTPM) device that is part of Intel chipsets. It provides credential storage and key management that can replace the equivalent functionality of a discrete TPM chip. <b>i</b> <b>NOTE:</b> The options that are listed apply to computers with a discrete <b>Trusted Platform Module (TPM)</b> .
PTT On	Enables or disables the Intel PTT option. By default, the <b>PTT On</b> option is enabled. For additional security, Dell Technologies recommends keeping the <b>PTT On</b> option enabled.

**Table 31. System setup options—Security menu (continued)**

<b>Security</b>	
Physical Presence Interface (PPI) Bypass for Clear Commands	<p>The PPI Bypass for Clear Commands option allows the operating system to manage certain aspects of PTT. When enabled, you are not prompted to confirm changes to the PTT configuration.</p> <p>By default, the <b>PPI Bypass for Clear Commands</b> option is disabled.</p> <p>For additional security, Dell Technologies recommends keeping the <b>PPI Bypass for Clear Commands</b> option disabled.</p>
Clear	<p>When enabled, the <b>Clear</b> option clears the information that is stored in the PTT fTPM after exiting the computer's BIOS. This option returns to the disabled state when the computer restarts.</p> <p>By default, the <b>Clear</b> option is disabled.</p> <p>Dell Technologies recommends enabling the <b>Clear</b> option only when PTT fTPM data needs to be cleared.</p>
<b>Chassis intrusion</b>	
Chassis Intrusion Detection	<p>The chassis intrusion detection enables a physical switch that triggers an event when the computer cover is opened.</p> <p>When set to <b>Enabled</b>, a notification is displayed on the next boot and the event is logged in the BIOS Events log.</p> <p>When set to <b>On-Silent</b>, the event is logged in the BIOS Events log, but no notification is displayed.</p> <p>When set to <b>Disabled</b>, no notification is displayed and no event is logged in the BIOS Events log.</p> <p>By default, the <b>Chassis Intrusion Detection</b> option is enabled.</p> <p>For additional security, Dell Technologies recommends keeping the <b>Chassis Intrusion Detection</b> option enabled.</p>
Block Boot Until Cleared	<p>Enables or disables the Block Boot Until Cleared option.</p> <p>By default, the <b>Block Boot Until Cleared</b> option is enabled.</p> <p><b>i</b> <b>NOTE:</b> When enabled, the computer does not boot until the chassis intrusion is cleared. If the administrator password is set, Setup has to be unlocked before the warning can be cleared.</p>
OROM Keyboard Access	<p>The OROM Keyboard Access feature allows you to enter the Option ROM configuration screens using hotkeys during the boot process. This setting controls only the Intel RAID (CTRL+I), MEBX (CTRL+P), and LSI RAID (CTRL+C) Option ROMs. Other preboot Option ROMs which support entry via a key sequence are not affected by this setting.</p> <p>For additional security, Dell Technologies recommends keeping the <b>OROM Keyboard Access</b> option enabled.</p>
<b>Legacy Manageability Interface Access</b>	<p>Allows the administrator to control the access to BIOS configuration through the Legacy Manageability Interface option. When enabled, this prevents the BIOS Administrator password-based manageability tools from running, prevents some Dell software applications from reading configuration settings, and/or prevents changes to the BIOS configuration settings.</p> <p>When enabled, this option only supports the Authenticated BIOS Manageability Interface (ABI) for managing the BIOS configuration changes. To support this feature, ABI must be enabled and provisioned.</p> <p>When set to <b>Enabled</b>, the Legacy Manageability Interface can be used to read and change BIOS configuration settings.</p> <p>When set to <b>Read-Only</b>, BIOS configuration settings can be read, but cannot be changed through the Legacy Manageability Interface.</p>

**Table 31. System setup options—Security menu (continued)**

<b>Security</b>	
	When set to <b>Disabled</b> , the Legacy Manageability Interface is disabled. BIOS configuration reads and writes are blocked.
<b>SMM Security Mitigation</b>	<p>Enables or disables additional UEFI SMM Security Mitigation protections. This option uses the Windows SMM Security Mitigations Table (WSMT) to confirm to the operating system that security best practices have been implemented by the UEFI firmware.</p> <p>By default, the <b>SMM Security Mitigation</b> option is enabled.</p> <p>For additional security, Dell Technologies recommends keeping the <b>SMM Security Mitigation</b> option enabled unless you have a specific application which is not compatible.</p> <p> <b>NOTE:</b> This feature may cause compatibility issues or loss of functionality with some legacy tools and applications.</p>
<b>Data Wipe on Next Boot</b>	
Start Data Wipe	<p>Data Wipe is a secure wipe operation that deletes information from a storage device.</p> <p> <b>CAUTION:</b> The secure Data Wipe operation deletes information in a way that it cannot be reconstructed.</p> <p>Commands such as delete and format in the operating system may remove files from showing up in the file system. However, they can be reconstructed through forensic means as they are still represented on the physical media. Data Wipe prevents this reconstruction and is not recoverable.</p> <p>When enabled, the data wipe option will prompt to wipe any storage devices that are connected to the computer on the next boot.</p> <p>By default, the <b>Start Data Wipe</b> option is disabled.</p>
Absolute	<p>Absolute Software provides various cyber security solutions, some requiring software preloaded on Dell computers and integrated into the BIOS. To use these features, you must enable the Absolute BIOS setting and contact Absolute for configuration and activation.</p> <p>By default, the <b>Absolute</b> option is enabled.</p> <p>For additional security, Dell Technologies recommends keeping the <b>Absolute</b> option enabled.</p> <p> <b>NOTE:</b> When the Absolute features are activated, the Absolute integration cannot be disabled from the BIOS setup screen.</p>
<b>UEFI Boot Path Security</b>	
UEFI Boot Path Security	<p>Enables or disables the computer to prompt the user to enter the Administrator password (if set) when booting to a UEFI boot path device from the F12 boot menu.</p> <p>By default, the <b>Always Except Internal HDD</b> option is enabled.</p>
<b>Firmware Device Tamper Detection</b>	<p>Allows you to control the firmware device tamper detection feature. This feature notifies the user when the firmware device is tampered. When enabled, a screen warning messages are displayed on the computer and a tamper detection event is logged in the BIOS Events log. The computer fails to reboot until the event is cleared.</p> <p>By default, the <b>Firmware Device Tamper Detection</b> option is enabled.</p> <p>For additional security, Dell Technologies recommends keeping the <b>Firmware Device Tamper Detection</b> option enabled.</p>

**Table 32. System setup options—Passwords menu**

<b>Passwords</b>	
<b>Administrator Password</b>	<p>The Administrator Password prevents unauthorized access to the BIOS Setup options. Once the administrator password is set, the BIOS setup options can only be modified after providing the correct password.</p> <p>The following rules and dependencies apply to the Administrator Password -</p> <ul style="list-style-type: none"> <li>● The administrator password cannot be set if computer and/or internal hard drive passwords are previously set.</li> <li>● The administrator password can be used in place of the computer and/or internal hard drive passwords.</li> <li>● When set, the administrator password must be provided during a firmware update.</li> <li>● Clearing the administrator password also clears the computer password (if set).</li> </ul> <p>Dell Technologies recommends using an administrator password to prevent unauthorized changes to BIOS setup options.</p>
<b>System Password</b>	<p>The System Password prevents the computer from booting to an operating system without entering the correct password.</p> <p>The following rules and dependencies apply when the System Password is used -</p> <ul style="list-style-type: none"> <li>● The computer shuts down when idle for approximately 10 minutes at the computer password prompt.</li> <li>● The computer shuts down after three incorrect attempts to enter the computer password.</li> <li>● The computer shuts down when the <b>Esc</b> key is pressed at the System Password prompt.</li> <li>● The computer password is not prompted when the computer resumes from standby mode.</li> </ul> <p>Dell Technologies recommends using the computer password in situations where it is likely that a computer may be lost or stolen.</p>
<b>Hard Drive Password</b>	<p>The Hard Drive Password can be set to prevent unauthorized access of the data stored on the hard drive. The computer prompts for the hard drive password during boot in order to unlock the drive. A password-secured hard drive stays locked even when removed from the computer or placed into another computer. It prevents an attacker from accessing data on the drive without authorization.</p> <p>The following rules and dependencies apply when the Hard Drive Password is used -</p> <ul style="list-style-type: none"> <li>● The hard drive password option cannot be accessed when a hard drive is disabled in the BIOS setup.</li> <li>● The computer shuts down when idle for approximately 10 minutes at the hard drive password prompt.</li> <li>● The computer shuts down after three incorrect attempts to enter the hard drive password and treats the hard drive as not available.</li> <li>● The hard drive does not accept password unlock attempts after five incorrect attempts to enter the hard drive password from the BIOS Setup. The hard drive password must be reset for the new password unlock attempts.</li> <li>● The computer treats the hard drive as not available when the <b>Esc</b> key is pressed at the hard drive password prompt.</li> <li>● The hard drive password is not prompted when the computer resumes from standby mode. When the hard drive is unlocked by the user before the computer goes into standby mode, it remains unlocked after the computer resumes from standby mode.</li> <li>● If the computer and hard drive passwords are set to the same value, the hard drive unlocks after the correct computer password is entered.</li> </ul> <p>Dell Technologies recommends using a hard drive password to protect unauthorized data access.</p>

**Table 32. System setup options—Passwords menu (continued)**

<b>Passwords</b>	
<b>Owner Password</b>	<p>The Owner Password is typically used when a computer is loaned or leased, and the end user sets their own computer or hard drive password. The Owner Password can provide override access to unlock the computer when it is returned. The Owner Password cannot be set using BIOS Setup. System lessors are given a tool which enables them to configure the Owner Password.</p> <p>The following rules and dependencies apply when the Owner Password is used -</p> <ul style="list-style-type: none"> <li>• The owner password cannot be set when the administrator password is already set.</li> <li>• The owner password can be used in place of the administrator, computer, or hard drive passwords.</li> </ul> <p><b>i</b> <b>NOTE:</b> The hard drive password must have been set on the computer with the owner password.</p> <p>Dell Technologies recommends that only computer lessors use the owner password.</p>
<b>Strong Password</b>	<p>The Strong Password feature enforces stricter rules for administrator, owner, and computer passwords.</p> <p>When enabled, the following rules are enforced -</p> <ul style="list-style-type: none"> <li>• The minimum length of the password is set to eight characters.</li> <li>• The password is required to include at least one upper case and one lower case character.</li> </ul> <p><b>i</b> <b>NOTE:</b> These requirements do not affect the hard drive password.</p> <p>By default, the <b>Strong Password</b> option is enabled.</p> <p>For additional security, Dell Technologies recommends keeping the <b>Strong Password</b> option enabled as it requires passwords to be more complex.</p>
<b>Password Configuration</b>	<p>The Password configuration page includes several options for changing the requirements of BIOS passwords. You can modify the minimum and maximum length of the passwords and require passwords to contain certain character classes (upper case, lower case, digit, special character).</p> <p>Dell Technologies recommends setting the minimum password length to at least eight characters.</p>
<b>Password Bypass</b>	<p>The <b>Password Bypass</b> option allows the computer to reboot from the operating system without entering the computer or hard drive password. If the computer has already booted to the operating system, it is presumed that the user has already entered the correct computer or hard drive password.</p> <p><b>i</b> <b>NOTE:</b> This option does not remove the requirement to enter the password after shutting down.</p> <p>By default, the <b>Password Bypass</b> option is enabled.</p> <p>For additional security, Dell Technologies recommends keeping the <b>Password Bypass</b> option enabled.</p>
<b>Password Changes</b>	
Allow Non-Admin Password Changes	<p>The <b>Allow Non-Admin Password Changes</b> option in BIOS setup allows an end user to set or change the computer or hard drive passwords without entering the administrator password. This gives an administrator control over the BIOS settings but enables an end user to provide their own password.</p> <p>By default, the <b>Allow Non-Admin Password Changes</b> option is disabled.</p> <p>For additional security, Dell Technologies recommends keeping the <b>Allow Non-Admin Password Changes</b> option disabled.</p>
Non-Admin Setup Changes	<p>The <b>Non-Admin Setup Changes</b> option allows an end user to configure the wireless devices without requiring the administrator password.</p>

**Table 32. System setup options—Passwords menu (continued)**

<b>Passwords</b>	
	<p>By default, the <b>Non-Admin Setup Changes</b> option is disabled.</p> <p>For additional security, Dell Technologies recommends keeping the <b>Non-Admin Setup Changes</b> option disabled.</p>
<b>Admin Setup Lockout</b>	<p>The <b>Admin Setup Lockout</b> option prevents an end user from even viewing the BIOS setup configuration without first entering the administrator password (if set).</p> <p>By default, the <b>Admin Setup Lockout</b> option is disabled.</p> <p>For additional security, Dell Technologies recommends keeping the <b>Admin Setup Lockout</b> option disabled.</p>
<b>Recovery Password</b>	<p>The Recovery Password can be used when a system owner forgets the administrator, system, or hard drive password. You can get an unlock code from Dell Support over the phone after verifying ownership details. The unlock code overrides and removes the existing password.</p> <p><b>i NOTE:</b> When a hard drive password is overridden using this method, the data on the hard drive is erased if secure erase was enabled when setting the password.</p>
<b>Master Password Lockout</b>	
Enable Master Password Lockout	<p>The Master Password Lockout setting allows you to disable the Recovery Password feature. If the computer, administrator, or hard drive password is forgotten, the computer becomes unusable.</p> <p><b>i NOTE:</b> When the owner password is set, the Master Password Lockout option is not available.</p> <p><b>i NOTE:</b> When an internal hard drive password is set, it must first be cleared before Master Password Lockout can be changed.</p> <p>By default, the <b>Enable Master Password Lockout</b> option is disabled.</p> <p>Dell does not recommend enabling the <b>Master Password Lockout</b> unless you have implemented your own password recovery computer.</p>

**Table 33. System setup options—Update, Recovery menu**

<b>Update, Recovery</b>	
<b>UEFI Capsule Firmware Updates</b>	
Enable UEFI Capsule Firmware Updates	<p>Enables or disables BIOS updates through UEFI capsule update packages.</p> <p><b>i NOTE:</b> Disabling this option blocks the BIOS updates from services such as Microsoft Windows Update and Linux Vendor Firmware Service (LVFS).</p> <p>By default, the <b>Enable UEFI Capsule Firmware Updates</b> option is enabled.</p>
<b>BIOS Recovery from Hard Drive</b>	<p>Enables or disables the user to recover from certain corrupted BIOS conditions from a recovery file on the user primary hard drive or an external USB key.</p> <p>By default, the <b>BIOS Recovery from Hard Drive</b> option is enabled.</p> <p><b>i NOTE:</b> BIOS Recovery from Hard Drive is not available for self-encrypting drives (SED).</p> <p><b>i NOTE:</b> BIOS recovery is designed to fix the main BIOS block and cannot work if the Boot Block is damaged. In addition, this feature cannot work in the event of EC corruption, ME corruption, or a hardware issue. The recovery image must exist on an unencrypted partition on the drive.</p>
<b>BIOS Downgrade</b>	
Allow BIOS Downgrade	Controls flashing of the computer firmware to previous revisions.



**Table 33. System setup options—Update, Recovery menu (continued)**

Update, Recovery	
	By default, the <b>Allow BIOS Downgrade</b> option is enabled.
<b>SupportAssist OS Recovery</b>	Enables or disables the boot flow for SupportAssist OS Recovery tool in the event of certain computer errors.  By default, the <b>SupportAssist OS Recovery</b> option is enabled.
<b>BIOSConnect</b>	Enables or disables cloud Service operating system recovery if the main operating system fails to boot with the number of failures equal to or greater than the value specified by the Auto operating system Recovery Threshold setup option and local Service operating system does not boot or is not installed.  By default, the <b>BIOSConnect</b> option is enabled.
<b>Dell Auto OS Recovery Threshold</b>	Allows you to control the automatic boot flow for SupportAssist System Resolution Console and for Dell operating system Recovery Tool.  By default, the <b>Dell Auto OS Recovery Threshold</b> value is set to 2.

**Table 34. System setup options—System Management menu**

System Management	
<b>Service Tag</b>	Displays the Service Tag of the computer.
<b>Asset Tag</b>	Creates a computer Asset Tag that can be used by an IT administrator to uniquely identify a particular computer.   <b>NOTE:</b> Once set in BIOS, the Asset Tag cannot be changed.
AC Behavior	
Wake on AC	Enables or disables the computer to turn on and go to boot when AC power is supplied to the computer.  By default, the <b>Wake on AC</b> option is disabled.
<b>Wake on LAN</b>	Enables or disables the computer to turn on by a special LAN signal.  By default, the <b>Wake on LAN</b> option is disabled.
<b>Auto On Time</b>	Enable to set the computer to turn on automatically every day or on a preselected date and time. This option can be configured only if the Auto On Time is set to Everyday, Weekdays, or Selected Days.  By default, the <b>Auto On Time</b> option is disabled.

**Table 35. System setup options—Keyboard menu**

Keyboard	
<b>Fn Lock Options</b>	Enables or disables the Fn Lock option.  By default, the <b>Fn Lock</b> option is enabled.
<b>Lock Mode</b>	By default, the <b>Lock Mode Secondary</b> option is enabled. With this option, the F1-F12 keys scan the code for their secondary functions.
<b>Keyboard Illumination</b>	Configures the operating mode of the keyboard illumination feature.  By default, the <b>Bright</b> option is selected. Enables the keyboard illumination feature at 100% brightness level.
<b>Keyboard Backlight Timeout on AC</b>	Sets the timeout value for the keyboard backlight when an AC adapter is connected to the computer.  By default, the <b>10 seconds</b> option is selected.

**Table 35. System setup options—Keyboard menu (continued)**

Keyboard	
<b>Keyboard Backlight Timeout on Battery</b>	<p>Sets the timeout value for the keyboard backlight when the computer is running only on the battery power. The keyboard backlight timeout value is only effective when the backlight is enabled.</p> <p>By default, the <b>10 seconds</b> option is selected.</p>
<b>Device Configuration HotKey Access</b>	<p>Allows you to control whether you can access device configuration screens through hotkeys during computer startup.</p> <p>By default, the <b>Device Configuration HotKey Access</b> option is enabled.</p> <p><b>NOTE:</b> This setting controls only the Intel RAID (CTRL+I), MEBX (CTRL+P), and LSI RAID (CTRL+C) Option ROMs. Other preboot Option ROMs, which support entry using a key sequence, are not affected by this setting.</p>

**Table 36. System setup options—Pre-boot Behavior menu**

Pre-boot Behavior	
<b>Warnings and Errors</b>	
Warnings and Errors	<p>Selects an action on encountering a warning or error during boot.</p> <p>Default: Prompt on Warnings and Errors. Stop, prompt, and wait for user input when warnings or errors are detected.</p> <p><b>NOTE:</b> Errors deemed critical to the operation of the computer hardware will always halt the computer.</p>
<b>Fastboot</b>	
Fastboot	<p>Configures the speed of the UEFI boot process.</p> <p>Default: Thorough. Performs complete hardware and configuration initialization during boot.</p>
<b>Extend BIOS POST Time</b>	
Extend BIOS POST Time	<p>Configures the BIOS POST (Power-On Self-Test) load time.</p> <p>Default: 0 seconds</p>

**Table 37. System setup options—Virtualization menu**

Virtualization Support	
<b>Intel Virtualization Technology</b>	
Enable Intel Virtualization Technology (VT)	<p>When enabled, the computer can run a Virtual Machine Monitor (VMM).</p> <p>By default, the <b>Enable Intel Virtualization Technology (VT)</b> option is enabled.</p>
<b>VT for Direct I/O</b>	
Enable Intel VT for Direct I/O	<p>When enabled, the computer can perform Virtualization Technology for Direct I/O (VT-d). VT-d is an Intel method that provides virtualization for memory map I/O.</p> <p>By default, the <b>Enable Intel VT for Direct I/O</b> option is enabled.</p>
<b>Intel Trusted Execution Technology (TXT)</b>	<p>Intel Trusted Execution Technology (TXT) is a set of hardware extensions to Intel processors and chipsets. It provides a hardware-based root of trust to ensure that a platform boots with a known good configuration of firmware, BIOS, virtual machine monitor, and operating system. The following must be enabled in order to enable Intel TXT -</p> <ul style="list-style-type: none"> <li>• Intel Virtualization Technology - X</li> <li>• Intel Virtualization Technology - Direct</li> </ul> <p>By default, the <b>Intel Trusted Execution Technology (TXT)</b> option is enabled.</p>

**Table 37. System setup options—Virtualization menu (continued)**

<b>Virtualization Support</b>	
	For additional security, Dell Technologies recommends keeping the <b>Intel Trusted Execution Technology (TXT)</b> option enabled.
<b>DMA Protection</b>	
Enable Pre-Boot DMA Support	<p>Allows you to control the Pre-Boot DMA protection for both internal and external ports. This option does not directly enable DMA protection in the operating system.</p> <p><b>NOTE:</b> This option is not available when the virtualization setting for IOMMU is disabled (VT-d/AMD Vi).</p> <p>By default, the <b>Enable Pre-Boot DMA Support</b> option is enabled.</p> <p>For additional security, Dell Technologies recommends keeping the <b>Enable Pre-Boot DMA Support</b> option enabled.</p> <p><b>NOTE:</b> This option is provided only for compatibility purposes, since some older hardware is not DMA capable.</p>
Enable OS Kernel DMA Support	<p>Allows you to control the Kernel DMA protection for both internal and external ports. This option does not directly enable DMA protection in the operating system. For operating systems that support DMA protection, this setting indicates to the operating system that the BIOS supports the feature.</p> <p><b>NOTE:</b> This option is not available when the virtualization setting for IOMMU is disabled (VT-d/AMD Vi).</p> <p>By default, the <b>Enable OS Kernel DMA Support</b> option is enabled.</p> <p><b>NOTE:</b> This option is provided only for compatibility purposes, since some older hardware is not DMA capable.</p>

**Table 38. System setup options—Performance menu**

<b>Performance</b>	
<b>Multi-Core Support</b>	
Multiple Atom Cores	<p>Enables to change the number of Atom cores available to the operating system. The default value is set to the maximum number of cores.</p> <p>By default, the <b>All Cores</b> option is selected.</p>
<b>Intel SpeedStep</b>	
Enable Intel SpeedStep Technology	<p>Enables the computer to dynamically adjust processor voltage and core frequency, decreasing average power consumption and heat production.</p> <p>By default, the <b>Enable Intel SpeedStep Technology</b> option is enabled.</p>
<b>C-State Control</b>	
Enable C-State Control	<p>Enables or disables the ability of the CPU to enter and exit low-power state. When disabled, it disables all C-states. When enabled, it enables all C-states that the chipset or platform allows.</p> <p>By default, the <b>Enable C-State Control</b> option is enabled.</p>
<b>Intel Turbo Boost Technology</b>	
Enable Intel Turbo Boost Technology	<p>Enables the Intel TurboBoost mode of the processor. When enabled, the Intel TurboBoost driver increases the performance of the CPU or graphics processor.</p> <p>By default, the <b>Enable Intel Turbo Boost Technology</b> option is enabled.</p>
<b>Intel Hyper-Threading Technology</b>	

**Table 38. System setup options—Performance menu (continued)**

<b>Performance</b>	
Enable Intel Hyper-Threading Technology	<p>Enables the Intel Hyper-Threading mode of the processor. When enabled, the Intel Hyper-Threading increases the efficiency of the processor resources when multiple threads run on each core.</p> <p>By default, the <b>Intel Hyper-Threading Technology</b> option is enabled.</p>
<b>Dynamic Tuning: Machine Learning</b>	
Enable Dynamic Tuning: Machine Learning	<p>Enables or disables operating system capability to enhance power tuning capabilities depending on the detected workloads.</p> <p> <b>NOTE:</b> This option is available for development only and is not customer visible.</p> <p>By default, the <b>Enable Dynamic Tuning: Machine Learning</b> option is enabled.</p>

**Table 39. System setup options—System Logs menu**

<b>System Logs</b>	
<b>BIOS Event Log</b>	
Clear BIOS Event Log	<p>Allows you to select option to keep or clear BIOS events logs.</p> <p>By default, the <b>Keep Log</b> option is selected.</p>
<b>Thermal Event Log</b>	
Clear Thermal Event Log	<p>Allows you to select option to keep or clear Thermal events logs.</p> <p>By default, the <b>Keep Log</b> option is selected.</p>
<b>Power Event Log</b>	
Clear Power Event Log	<p>Allows you to select option to keep or clear Power events logs.</p> <p>By default, the <b>Keep Log</b> option is selected.</p>

## System and setup password

**Table 40. System and setup password**

<b>Password type</b>	<b>Description</b>
System password	Password that you must enter to log on to your system.
Setup password	Password that you must enter to access and make changes to the BIOS settings of your computer.

You can create a system password and a setup password to secure your computer.

 **CAUTION:** The password features provide a basic level of security for the data on your computer.

 **CAUTION:** Anyone can access the data stored on your computer if it is not locked and left unattended.

 **NOTE:** System and setup password feature is disabled.

## Assigning a System Setup password

### Prerequisites

You can assign a new System or Admin Password only when the status is in **Not Set**.

### About this task

To enter BIOS System Setup, press F2 immediately after a power-on or reboot.

### Steps

1. In the **System BIOS** or **System Setup** screen, select **Security** and press Enter.  
The **Security** screen is visible.
2. Select **System/Admin Password** and create a password in the **Enter the new password** field.  
Use the following guidelines to assign the system password:
  - A password can have up to 32 characters.
  - At least one special character: ! " # \$ % & ' ( ) \* + , - . / : ; < = > ? @ [ \ ] ^ \_ ` { | }
  - Numbers 0 through 9.
  - Upper case letters from A to Z.
  - Lower case letters from a to z.
3. Type the system password that you entered earlier in the **Confirm new password** field and click **OK**.
4. Press Esc and save the changes as prompted by the pop-up message.
5. Press Y to save the changes.  
The computer restarts.

## Deleting or changing an existing system setup password

### Prerequisites

Ensure that the **Password Status** is Unlocked (in the System Setup) before attempting to delete or change the existing System and/or Setup password. You cannot delete or change an existing System or Setup password, if the **Password Status** is Locked.

### About this task

To enter the System Setup, press F2 immediately after a power-on or reboot.

### Steps

1. In the **System BIOS** or **System Setup** screen, select **System Security** and press Enter.  
The **System Security** screen is displayed.
2. In the **System Security** screen, verify that the Password Status is **Unlocked**.
3. Select **System Password**, update, or delete the existing system password, and press Enter or Tab.
4. Select **Setup Password**, update, or delete the existing setup password, and press Enter or Tab.  
 **NOTE:** If you change the System and/or Setup password, reenter the new password when prompted. If you delete the System and/or Setup password, confirm the deletion when prompted.
5. Press Esc. A message prompts you to save the changes.
6. Press Y to save the changes and exit from System Setup.  
The computer restarts.

## Real Time Clock (RTC) reset

The Real Time Clock (RTC) reset function allows you or the service technician to recover the recently launched model Dell computers from **No POST/No Boot/No Power** situations. You can initiate the RTC reset on the computer from a power-off state only if it is connected to AC power. Press and hold the power button for 30 seconds. The computer RTC reset occurs after you release the power button.

 **NOTE:** The RTC reset is aborted if the power button is held for less than 25 seconds or more than 40 seconds.

The RTC reset restores the BIOS to defaults and resets the computer's date and time. The computer restarts several times during the reset process. Depending on how the computer is configured, you may see LED indications during the period the power button is held and after it is released. Once the reset is complete, the computer restarts and the Dell logo appears indicates reset success.

**CAUTION:** Once RTC reset is complete, the computer may remain in a no-boot status until the time, date, and other BIOS settings are correctly set to boot in Windows. Failing to boot immediately after a reset does not mean that the reset has failed. You must restore the previous BIOS settings, such as the SATA Operation mode (ex. RAID On AHCI) for the computer to reboot normally.

The following items are unaffected by the RTC reset:

- TPM (remains on and enabled if it was in that state prior to RTC reset)
- Service Tag
- Asset Tag
- Ownership Tag
- Admin Password
- System Password
- Hard drive Password
- Key Databases
- System Logs

The following items may or may not reset based on your custom BIOS setting selections:

- Boot List
- Secure Boot Enable
- Allow BIOS Downgrade
- Password clear

The Master System Password is used to clear the admin and computer password.

To clear the system or BIOS passwords, contact Dell technical support as described at [www.dell.com/contactdell](http://www.dell.com/contactdell).

**NOTE:** For information on how to reset Windows or application passwords, refer to the documentation accompanying Windows or your application.

## Clearing BIOS (System Setup) and System passwords

### About this task

To clear the system or BIOS passwords, contact Dell technical support as described at [www.dell.com/contactdell](http://www.dell.com/contactdell).

**NOTE:** For information about how to reset Windows or application passwords, see the documentation accompanying Windows or your application.

## Updating the BIOS

### Updating the BIOS in Windows

#### Steps

1. Go to [www.dell.com/support](http://www.dell.com/support).
2. Click **Product support**. In the **Search support** box, enter the Service Tag of your computer, and then click **Search**.  
**NOTE:** If you do not have the Service Tag, use the SupportAssist feature to automatically identify your computer. You can also use the product ID or manually browse for your computer model.
3. Click **Drivers & Downloads**. Expand **Find drivers**.
4. Select the operating system installed on your computer.
5. In the **Category** drop-down list, select **BIOS**.
6. Select the latest version of BIOS, and click **Download** to download the BIOS file for your computer.
7. After the download is complete, browse the folder where you saved the BIOS update file.
8. Double-click the BIOS update file icon and follow the on-screen instructions.

For more information about how to update the system BIOS, search in the Knowledge Base Resource at [www.dell.com/support](http://www.dell.com/support).

# Updating the BIOS using the USB drive in Windows

## Steps

1. Follow the procedure from step 1 to step 6 in [Updating the BIOS in Windows](#) to download the latest BIOS setup program file.
2. Create a bootable USB drive. For more information, search the Knowledge Base Resource at [www.dell.com/support](http://www.dell.com/support).
3. Copy the BIOS setup program file to the bootable USB drive.
4. Connect the bootable USB drive to the computer that needs the BIOS update.
5. Restart the computer and press **F12**.
6. Select the USB drive from the **One Time Boot Menu**.
7. Type the BIOS setup program filename and press **Enter**.  
The **BIOS Update Utility** appears.
8. Follow the on-screen instructions to complete the BIOS update.

# Updating the BIOS from the F12 One Time Boot menu

Update your computer BIOS using the BIOS update.exe file that is copied to a FAT32 USB drive and booting from the F12 **One Time Boot** menu.

## About this task

### BIOS Update

You can run the BIOS update file from Windows using a bootable USB drive or you can also update the BIOS from the F12 **One Time Boot** menu on the computer.

Most of the Dell computers built after 2012 have this capability, and you can confirm by booting your computer to the F12 **One Time Boot** Menu to see if BIOS FLASH UPDATE is listed as a boot option for your computer. If the option is listed, then the BIOS supports this BIOS update option.

 **NOTE:** Only computers with the BIOS Flash Update option in the F12 **One Time Boot** menu can use this function.

## Updating from the One Time Boot menu

To update your BIOS from the F12 **One Time Boot** menu, you need the following:

- USB drive formatted to the FAT32 file system (key does not have to be bootable)
- BIOS executable file that you downloaded from the Dell Support website and copied to the root of the USB drive
- AC power adapter that is connected to the computer
- Functional computer battery to flash the BIOS

Perform the following steps to perform the BIOS update flash process from the F12 menu:

 **CAUTION:** Do not turn off the computer during the BIOS update process. The computer may not boot if you turn off your computer.

## Steps

1. From a turn off state, insert the USB drive where you copied the flash into a USB port of the computer.
2. Turn on the computer and press F12 to access the **One Time Boot** Menu, select BIOS Update using the mouse or arrow keys then press Enter.  
The flash BIOS menu is displayed.
3. Click **Flash from file**.
4. Select an external USB device.
5. Select the file and double-click the flash target file, and then click **Submit**.
6. Click **Update BIOS**. The computer restarts to flash the BIOS.
7. The computer will restart after the BIOS update is completed.

# Troubleshooting

## Locate the Service Tag or Express Service Code of your Dell computer

Your Dell computer is uniquely identified with a Service Tag or Express Service Code. To view relevant support resources for your Dell computer, we recommend entering the Service Tag or Express Service Code at [www.dell.com/support](http://www.dell.com/support).

For more information about how to find the Service Tag for your computer, see [Locate the Service Tag on your computer](#).

## SupportAssist diagnostics

### About this task

The SupportAssist diagnostics (previously known as ePSA diagnostics) performs a complete check of your hardware. The SupportAssist diagnostics is embedded in the BIOS and is launched by it internally. The SupportAssist diagnostics provides a set of options for particular devices or device groups. It allows you to:

- Run tests automatically or in an interactive mode.
- Repeat tests
- Display or save test results
- Run thorough tests to introduce additional test options and provide extra information about the failed device(s)
- View status messages that indicate if the tests are completed successfully
- View error messages that indicate if problems were encountered during the test

 **NOTE:** Some tests are meant for specific devices and require user interaction. Ensure that you are present in front of the computer when the diagnostic tests are performed.

For more information, see [SupportAssist Pre-Boot System Performance Check](#).

## System diagnostic lights

### Power-supply diagnostics light

Indicates the power-supply state.

### Hard-drive activity light

Turns on when the computer reads from or writes to the hard drive.

**Table 41. LED codes**

Diagnostic light codes	Problem description
1,1	TPM detection failure
1,2	Unrecoverable SPI flash failure
2,1	CPU failure
2,2	Motherboard, covers BIOS corruption or ROM error
2,3	No Memory/RAM detected
2,4	Memory/RAM failure
2,5	Invalid memory installed



**Table 41. LED codes (continued)**

Diagnostic light codes	Problem description
2,6	Motherboard/chipset error
3,1	CMOS battery failure
3,2	PCI of Video card/chip failure
3,3	Recovery Image not found
3,4	Recovery Image found but invalid
3,5	EC ran into power sequencing failure
3,6	Flash corruption detected by SBIOS
3,7	Timeout waiting on ME to reply to HECI message
4,1	Memory DIMM power rail failure
4,2	CPU power cable connection issue

## Recovering the operating system

When your computer is unable to boot to the operating system even after repeated attempts, it automatically starts Dell SupportAssist OS Recovery.

Dell SupportAssist OS Recovery is a stand-alone tool that is preinstalled in all Dell computers that are installed with the Windows operating system. It consists of tools to diagnose and troubleshoot issues that may occur before your computer boots to the operating system. It enables you to diagnose hardware issues, repair your computer, back up your files, or restore your computer to its factory state.

You can also download it from the Dell Support website to troubleshoot and fix your computer when it fails to boot into their primary operating system due to software or hardware failures.

For more information about the Dell SupportAssist OS Recovery, see *Dell SupportAssist OS Recovery User's Guide* at [www.dell.com/serviceabilitytools](http://www.dell.com/serviceabilitytools). Click **SupportAssist** and then, click **SupportAssist OS Recovery**.

## Wi-Fi power cycle

### About this task

If your computer is unable to access the Internet due to Wi-Fi connectivity issues a Wi-Fi power cycle procedure may be performed. The following procedure provides the instructions on how to conduct a Wi-Fi power cycle:

 **NOTE:** Some Internet Service Providers (ISPs) provide a modem or router combo device.

### Steps

1. Turn off your computer.
2. Turn off the modem.
3. Turn off the wireless router.
4. Wait for 30 seconds.
5. Turn on the wireless router.
6. Turn on the modem.
7. Turn on your computer.

# Drain residual flea power (perform hard reset)

## About this task

Flea power is the residual static electricity that remains in the computer even after it has been powered off and the battery is removed.

For your safety, and to protect the sensitive electronic components in your computer, you are requested to drain residual flea power before removing or replacing any components in your computer.

Draining residual flea power, also known as a performing a "hard reset", is also a common troubleshooting step if your computer does not power on or boot into the operating system.

## To drain residual flea power (perform a hard reset)

### Steps

1. Turn off your computer.
2. Disconnect the power adapter from your computer.
3. Press and hold the power button for 20 seconds to drain the flea power.
4. Connect the power adapter to your computer.
5. Turn on your computer.



 **NOTE:** For more information about performing a hard reset, see the knowledge base article [000130881](https://www.dell.com/support) at [www.dell.com/support](https://www.dell.com/support).

# Getting help and contacting Dell

## Self-help resources

You can get information and help on Dell products and services using these self-help resources:

**Table 42. Self-help resources**

Self-help resources	Resource location
Information about Dell products and services	<a href="http://www.dell.com">www.dell.com</a>
My Dell app	 <p><b>Figure 54. My Dell app</b></p>
Tips	 <p><b>Figure 55. Tips</b></p>
Contact Support	In Windows search, type <code>Contact Support</code> , and press Enter.
Online help for operating system	<a href="http://www.dell.com/support/windows">www.dell.com/support/windows</a> <a href="http://www.dell.com/support/linux">www.dell.com/support/linux</a>
Access top solutions, diagnostics, drivers and downloads, and learn more about your computer through videos, manuals, and documents.	<p>Your Dell computer is uniquely identified by a Service Tag or Express Service Code. To view relevant support resources for your Dell computer, enter the Service Tag or Express Service Code at <a href="http://www.dell.com/support">www.dell.com/support</a>.</p> <p>For more information about how to find the Service Tag for your computer, see <a href="#">Locate the Service Tag on your computer</a>.</p>
Dell knowledge base articles	<ol style="list-style-type: none"> <li>1. Go to <a href="http://www.dell.com/support">www.dell.com/support</a>.</li> <li>2. On the menu bar at the top of the Support page, select <b>Support &gt; Knowledge Base</b>.</li> <li>3. In the Search field on the Knowledge Base page, type the keyword, topic, or model number, and then click or tap the search icon to view the related articles.</li> </ol>

## Contacting Dell

To contact Dell for sales, technical support, or customer service issues, see [www.dell.com/contactdell](http://www.dell.com/contactdell).

 **NOTE:** Availability varies by country/region and product, and some services may not be available in your country/region.

 **NOTE:** If you do not have an active Internet connection, you can find contact information about your purchase invoice, packing slip, bill, or Dell product catalog.